

# **Liebert EXM 80kVA ~ 200kVA UPS**

## **User Manual**

Version: V1.7\_LT

Revision date: Dec 13, 2023

BOM: 31013268

---

Vertiv provides customers with technical support. Users may contact the nearest Vertiv local sales office or service center.

2015 Copyright, 2020 by Vertiv Tech Co., Ltd.

All rights reserved. The contents in this document are subject to change without notice.

Vertiv Tech Co., Ltd.

Address: Block B2, Nanshan I Park, No.1001 Xueyuan Road, Nanshan District, Shenzhen, 518055, P.R.China

Homepage: [www.Vertiv.com](http://www.Vertiv.com)

E-mail: [overseas.support@vertiv.com](mailto:overseas.support@vertiv.com)



## Special Declaration

### Personnel Safety

1. This product must be installed and commissioned by professional engineers of the manufacturer or its authorized agent. Failure to observe this could result in product malfunction or personnel safety risk.
2. Take the time to read this product manual and the safety precaution thoroughly before installing and commissioning this product. Failure to observe this could result in product malfunction or personnel safety risk.
3. For life support application is mandatory formal approval by Vertiv.
4. Never dispose of the internal or external battery of this product in a fire, as it may explode and jeopardize personnel safety when exposed to flame.

### Product Safety

1. If this product will be stored or remain de-energized for a long period, it must be placed in a dry and clean environment within specified temperature range.
2. This product should be used in an appropriate operating environment. For details, refer to the section on the environmental requirement in this manual.
3. This product is not designed for application in an environment:
  - Where the temperature and relative humidity are outside the specifications
  - Subject to vibrations or shocks
  - Where conductive dusts, corrosive gases, salts, or flammable gases are present
  - Near heat sources or strong electromagnetic interferences

### Disclaimer

Vertiv disclaims any and all responsibility or liability for the defects or malfunction caused by:

- Application range or operating environment outside the specifications
- Unauthorized modification, improper installation or operation
- Force majeure
- Other actions not in compliance with the instructions in this manual

## Safety Precaution

Always observe the following safety symbols!



Used to alert the user to the risk of death or severe injury should the unit be used improperly.



Used to alert the user to the risk of injury or equipment damage should the unit be used improperly.



Used to advise the user to carefully read and observe this unit though it may not cause damage.

This manual contains information concerning the installation and operation of the Liebert EXM 80kVA ~ 200kVA UPS.

Read this manual thoroughly before installing, using and servicing the UPS.



The UPS with standard configuration is a category C3 product for commercial and industrial application in the second environment. Installation restrictions or additional measures may be needed to prevent disturbances.



The UPS adding C2 EMC option based on the standard configuration is a category C2 product for a residential environment or commercial and industrial application in the second environment.

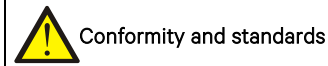

This product complies with CE 2006/95/EC (low voltage safety) and 2004/108/EC (EMC), EMC standards of Australia and New Zealand (C-Tick), and the following UPS product standards:

\* IEC62040-1 General safety requirements for UPS

\* IEC62040-2-EMC

\* IEC62040-3 Performance requirements and test methods

For details, refer to *Chapter 11 Specifications*.

Continued compliance requires installation in accordance with these instructions and the use of manufacturer approved accessories only.

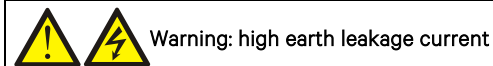

Earth connection is critical before connecting the input supply (including both mains supply and battery).

This equipment is installed with an EMC filter.

Earth leakage current is less than 3000mA.

Transient and steady state earth leakage currents, which may occur when the equipment is started, should be taken into account in the selection of instantaneous RCCBs or RCD devices.

RCCB which is sensitive to unidirectional DC pulse (class A) and insensitive to transient state current pulse must be selected.

Note also that the earth leakage currents of the load will be carried by the RCCBs or RCDs.

The equipment must be earthed in accordance with the local electrical code of practice.

**Warning**

The selection of the upstream distribution protection equipment of the UPS shall be selected in accordance with the details in 3.1.4 *Selection Of UPS I/O Switch* and shall comply with the local electrical regulations.

**Warning: backfeeding protection**

This UPS is fitted with a dry contact closure signal for use with an external automatic disconnect device (supplied by others) to protect against backfeeding voltage into the incoming terminal through the rectifier or bypass static switch circuit. A label must be added at all external incoming primary supply disconnect device to warn service personnel that the circuit is connected to a UPS. The text of the label has the following meaning: Risk of voltage backfeed! Isolate the UPS, then check for hazardous voltage between all terminals including the protective earth before working on this circuit.

**User serviceable components (For service personnel)**

All equipment maintenance and servicing procedures involving internal access requires the use of a tool and should be carried out only by trained personnel. There are no user-serviceable parts behind covers requiring a tool/key for removal.

**Battery voltage exceeds 400Vdc (For service personnel)**

All physical battery maintenance and servicing procedures requires the use of a tool/key and should be carried out only by trained personnel.

Take special care when working with the batteries associated with this UPS. When connected together, the battery terminal voltage will exceed 400Vdc and is potentially lethal.

Battery manufacturers supply details of the necessary precautions to be observed in working on, or in the vicinity of, a large bank of battery cells. These precautions should be followed implicitly at all times. Particular attention should be paid to the recommendations concerning local environmental conditions and the provision of protective clothing, first aid and fire-fighting facilities.

**General safety (For users)**

Like other types of large power equipment, the UPS and battery circuit breaker box/battery cabinet have high voltage inside. Because the components with high voltage can be accessed only when the front door is opened, the risk of contacting high voltage has been minimized. This equipment meets the IP20 standard, and other safety shields are provided inside the equipment.

There will not be any risk when operating this equipment according to the general instructions and the steps recommended in this manual.

**Multiple power inputs (For users)**

This UPS system receives power from more than one source. Disconnection of all AC source and the DC source is required before servicing.

This UPS has several circuits that are energized with high AC as well as DC voltages. Check for voltage with both AC and DC voltmeters before working within the UPS.

**Warning**

When the internal fuse of the UPS is damaged, it must be replaced with fuse of the same electric parameters by qualified personnel.

**Important**

Beside the communication board is a static sensitive area, an ESD-proof action is critical before contacting with this area.

**Warning**

The user must select an appropriate MCCB to protect against short circuit and overload for the battery. It is recommended to adopt Vertiv BCB to provide a better solution.

**The Manual Describes The Following Equipment**

Product	Model
80kVA	EXM 0080kTK16FN01000
100kVA	EXM 0100kTK16FN01000
120kVA	EXM 0120kTK16FN01000
160kVA	EXM 0160kTK16FN01000
200kVA	EXM 0200kTK16FN01000

## **Revision Information**

### **V1.0 (June 4, 2015)**

Initial release.

### **V1.1 (November 25, 2016)**

Update Sections 2.4, 3.1.2 ~ 3.1.5, 3.2.7, 8.2.1, 9.1; Tables 4-7, 8-1, 11-6; Figures 3-2, 3-6, 3-12, 5-1, 6-6; change 'dry contact card' to 'IS-RELAY'.

### **V1.2 (November 30, 2017)**

Update Table 3-5, Figure 6-6, Figure 8-1; change all the contents in Chapter 4; change most part of contents in Chapter 5; rearrange the sequence from Section 6.9; add Section 8.2.7; update Appendix 2; update information about Vertiv.

### **V1.3 (August 25, 2018)**

Update Tables 3-4~3-7.

### **V1.4 (January 15, 2019)**

Update images in Chapter 4.

### **V1.5 (August 12, 2019)**

Update Homepage and Email.

### **V1.6 (May 15, 2020)**

Refine the description at top of Figure 5-3.

### **V1.7\_LT (Dec 13, 2023)**

Update personnel safety.



# Contents

<b>Chapter 1 Overview</b> .....	1
1.1 Features .....	1
1.2 Design Concept .....	1
1.2.1 System Design .....	1
1.2.2 Bypass .....	2
1.2.3 System Control Principle .....	2
1.2.4 UPS Power Supply Switch Configuration .....	3
1.2.5 Battery Circuit Breaker (BCB) .....	4
1.3 Parallel System .....	4
1.3.1 Parallel System Features .....	4
1.3.2 Parallel System Requirements .....	4
1.4 Operation Modes .....	5
1.5 Battery Management .....	7
1.5.1 Normal Function .....	7
1.5.2 Advanced Function .....	8
1.5.3 Battery Temperature Compensation .....	9
1.6 Battery Protection .....	9
<b>Chapter 2 Mechanical Installation</b> .....	10
2.1 Precautions .....	10
2.2 Transportation .....	10
2.3 Tools .....	11
2.4 Unpacking .....	12
2.5 Initial Inspection .....	14
2.6 Environmental Requirement .....	14
2.6.1 UPS Location Selection .....	14
2.6.2 Battery Location Selection .....	14
2.6.3 Storage .....	14
2.7 Mechanical Requirement .....	15
2.7.1 Composition .....	15
2.7.2 Moving Cabinet .....	15
2.7.3 Clearance .....	15
2.7.4 Cable Access Mode .....	15
2.8 Installation Drawings .....	16
<b>Chapter 3 Electrical Installation</b> .....	17
3.1 Wiring Of Power Cable .....	17
3.1.1 System Configuration .....	17
3.1.2 Maximum Steady State AC And DC Currents .....	17

3.1.3 Recommended CSA Of UPS Cable .....	18
3.1.4 Selection Of UPS I/O And Battery Switch .....	18
3.1.5 Distance Between The UPS Connection Point And The Floor .....	18
3.1.6 Notes .....	18
3.1.7 Power Cable Connecting Terminal.....	18
3.1.8 Protection Ground .....	18
3.1.9 External Protective Device.....	19
3.1.10 Power Cable Connection Steps.....	20
3.2 Wiring Of Signal Cable .....	25
3.2.1 Overview .....	25
3.2.2 Dry Contact Port J21.....	26
3.2.3 Dry Contact Port J22 .....	26
3.2.4 Dry Contact Port J26.....	27
3.2.5 Programmable Dry Contact Ports J23 ~ J25 .....	28
3.2.6 REPO Port .....	29
3.2.7 RS232 Communication Port.....	30
3.2.8 Parallel And LBS Communication Ports .....	30
3.2.9 Intellislot Port .....	30
3.2.10 Signal Cable Connection Steps .....	30
<b>Chapter 4 Operator Control And Display Panel.....</b>	<b>35</b>
4.1 Introduction.....	35
4.2 Navigating Through The Liebert EXM Touchscreen Control Panel.....	36
4.2.1 Access Level Log-In .....	36
4.2.2 Liebert EXM Touchscreen Control Panel Components.....	37
4.3 Operation.....	41
4.3.1 Log In To The Liebert EXM Touchscreen Control Panel.....	41
4.3.2 Customizing The Display.....	42
4.3.3 Operator Controls .....	47
4.4 Viewing UPS Status .....	52
4.4.1 Viewing UPS Data With The Status Gauge .....	52
4.4.2 Viewing UPS Data With The Status Panel .....	56
4.4.3 Logs—Alarms And Events.....	61
4.5 Viewing UPS Component Status .....	63
4.6 Status Bar Component.....	65
4.6.1 Status Bar Messages.....	65
4.7 Alarm List .....	68
<b>Chapter 5 UPS Operation Introduction .....</b>	<b>71</b>
5.1 Brief Introduction .....	71
5.1.1 Precautions .....	71
5.1.2 Power Switch .....	71

5.2 UPS Startup Procedures .....	73
5.2.1 Startup Procedures In Normal Mode .....	73
5.2.2 Startup Procedures In ECO Mode .....	75
5.2.3 Startup Procedures In Battery Mode (Battery Cold Start) .....	76
5.3 Procedures For Transfer Between Operation Modes .....	76
5.3.1 Transfer From Normal Mode To Battery Mode .....	76
5.3.2 Transfer From Normal Mode To Bypass Mode .....	76
5.3.3 Transfer From Bypass Mode To Normal Mode .....	77
5.3.4 Transfer From Normal Mode To Maintenance Mode .....	77
5.3.5 Transfer From Maintenance Mode To Normal Mode .....	78
5.4 Battery Test Procedures .....	78
5.5 UPS Shutdown Procedures .....	80
5.5.1 Procedures For Completely Powering Down UPS .....	80
5.5.2 Procedures For Completely Powering Down UPS While Maintaining Power To Load .....	80
5.6 EPO Procedures .....	80
5.7 UPS Reset Procedures After EPO .....	80
5.8 Automatic Restart .....	81
5.9 Selecting Language .....	81
5.10 Changing Current Date And Time .....	82
5.11 Control Password .....	82
<b>Chapter 6 Battery .....</b>	<b>83</b>
6.1 Introduction .....	83
6.2 Safety .....	83
6.3 UPS Battery .....	84
6.4 Precautions For Installation Design .....	85
6.5 Battery Installation Environment And Number Of Batteries .....	85
6.5.1 Installation Environment .....	85
6.5.2 Number Of Batteries .....	86
6.6 Battery Protection .....	86
6.7 Battery Installation And Connection .....	87
6.7.1 Battery Installation .....	87
6.7.2 Battery Connection .....	87
6.8 Design Of Battery Room .....	87
6.9 Common Battery String .....	88
6.10 BCB Box (Option) .....	89
6.11 Battery Ground Fault Detector (Option) .....	91
6.12 BCB Reference Current And Connection .....	91
6.13 Battery Temperature Sensor (Option) .....	93
6.14 Battery Maintenance .....	93
6.15 Disposal Of Used Battery .....	93

<b>Chapter 7 Parallel System And LBS System</b> .....	95
7.1 General .....	95
7.2 System Installation Procedures .....	95
7.2.1 Preliminary Checks .....	95
7.2.2 Cabinet Installation .....	95
7.2.3 External protective device .....	96
7.2.4 Power Cable .....	96
7.2.5 Parallel Cable .....	97
7.2.6 Remote EPO .....	97
7.3 Operation Procedures For Parallel System .....	98
7.3.1 Startup Procedures In Normal Mode .....	98
7.3.2 Maintenance Bypass Procedures .....	99
7.3.3 Procedures For Isolating One UPS Module From Parallel System .....	100
7.3.4 Procedures For Inserting One Isolated UPS Module In Parallel System .....	100
7.3.5 Procedures For Completely Powering Down UPS .....	100
7.3.6 Procedures For Complete UPS Shutdown While Maintaining Power To Load .....	101
7.4 LBS System .....	101
7.4.1 Cabinet Installation .....	101
7.4.2 External Protective Device .....	102
7.4.3 Power Cable .....	103
7.4.4 LBS Cable .....	103
<b>Chapter 8 Options</b> .....	104
8.1 Option List .....	104
8.2 Option Introduction .....	105
8.2.1 Optional Switch Cabinet .....	105
8.2.2 Bypass Load Sharing Inductor Kit .....	111
8.2.3 Battery Temperature Sensor Kit .....	114
8.2.4 Battery Ground Fault Kit .....	115
8.2.5 Seismic Anchor Kit .....	116
8.2.6 IS-UNITY-DP Card .....	118
8.2.7 IS-UNITY-LIFE Card .....	118
8.2.8 SIC Card .....	119
8.2.9 IS-Relay Card .....	119
8.2.10 BCB Box .....	120
8.2.11 C2 Electromagnetic Shielding Assembly .....	120
8.2.12 Parallel Cable .....	121
8.2.13 LBS Cable .....	121
<b>Chapter 9 Communication</b> .....	122
9.1 SNMP Protocol Communication .....	122
9.2 Modbus Protocol Communication .....	122

9.3 Dry Contact Communication.....	122
9.3.1 Communication Through IS-Relay Card.....	123
9.3.2 Communication Through Dry Contact Port .....	123
<b>Chapter 10 Service And Maintenance .....</b>	<b>124</b>
10.1 Safety.....	124
10.2 Service Procedures Of Power Module And Bypass Module .....	124
10.2.1 Notes.....	124
10.2.2 Service Procedures Of Power Module .....	124
10.2.3 Service Procedures Of Bypass Module.....	125
10.3 Key Components And Service Life Of UPS .....	127
10.3.1 Life Parameters And The Proposed Replacement Time Of Key Components.....	127
10.3.2 Replacement Of Air Filter .....	127
10.4 Maintenance Of UPS And Options.....	128
<b>Chapter 11 Specifications .....</b>	<b>129</b>
11.1 Conformance And Standards.....	129
11.2 Environmental Characteristics .....	129
11.3 Mechanical Characteristics .....	129
11.4 Electrical Characteristics (Input Rectifier) .....	130
11.5 Electrical Characteristics (Intermediate DC Circuit) .....	130
11.6 Electrical Characteristics (Inverter Output) .....	130
11.7 Electrical Characteristics (Bypass Input) .....	131
11.8 Efficiency And Loss .....	131
<b>Appendix 1 Glossary .....</b>	<b>132</b>



## Chapter 1 Overview

This chapter briefly introduces the features, design concept, parallel system, operation mode, battery management and battery protection of the Liebert EXM UPS 80kVA ~ 200kVA (UPS for short).

### 1.1 Features

The UPS is connected between a critical load (e.g. a computer) and mains power to provide high quality power for the loads. The UPS has the following advantages:

- Augment power quality

The UPS protects its output against the input power change through the intelligent controller.

- Provide mains failure protection

If the input power fails, the UPS will work in battery mode, and the power supply to the loads will not be interrupted.

### 1.2 Design Concept

#### 1.2.1 System Design

This section introduces the working principle of the UPS single module. The UPS adopts AC-DC-AC converter (as shown in Figure 1-1). The first stage conversion (AC-DC) adopts three-phase high frequency rectifier to convert the three-phase input voltage into stable DC bus voltage.

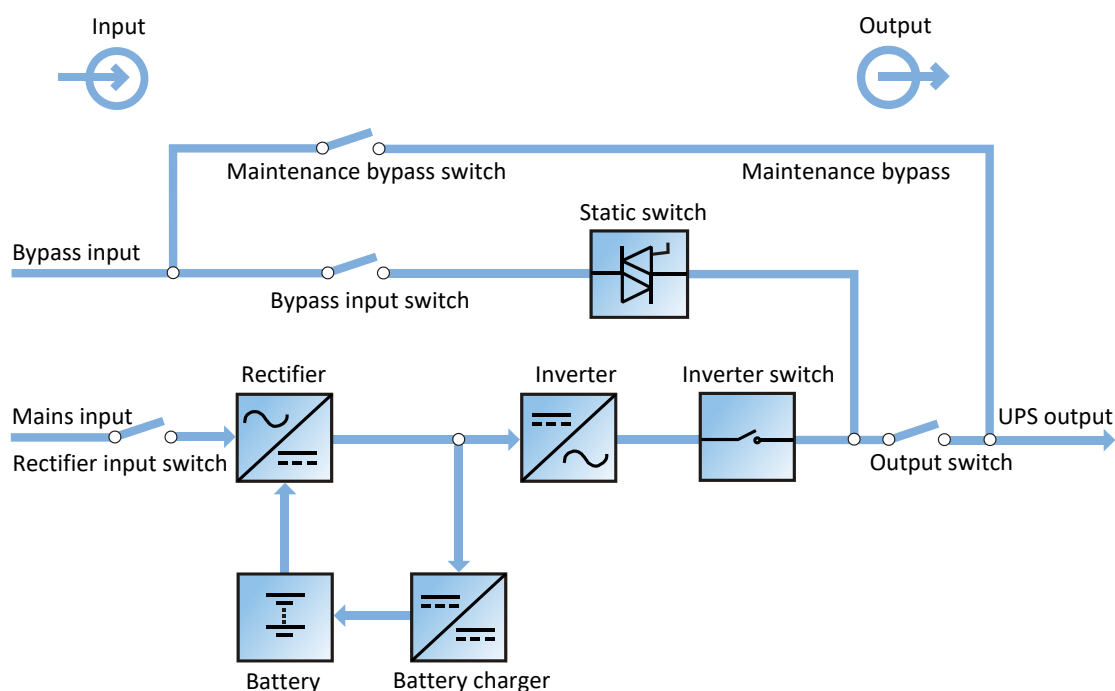

Figure 1-1 Block diagram for working principle of UPS single module

The UPS has its own battery charger and adopts advanced temperature compensation technology to effectively prolong the battery service life. The inverter mainly adopts large power IGBT, and adopts advanced SVPWM technology for control so as to invert the DC bus voltage back to AC voltage.

When the mains is normal, the rectifier and inverter work together to supply the loads and charge the battery.

When the mains is abnormal, the rectifier stops working, and the battery supplies power to the loads through the inverter. If the battery voltage falls to end of discharge (EOD) voltage and the mains still has not been recovered, the UPS will shut down (if the system uses split bypass configuration and the bypass is normal, the system will transfer to bypass). The

battery EOD voltage is preset. When the mains is abnormal, the battery maintains the UPS operation till the battery voltage is reduced to EOD voltage and the UPS shuts down, this time is called 'Backup Time'. The length of backup time depends on the battery capacity and the loads.

## 1.2.2 Bypass

Through the intelligent control of the 'Static Switch' module (as shown in Figure 1-1) containing the controllable electronic switch, the loads can be supplied by the inverter or the bypass. In normal situation, the loads are supplied by the inverter, in which case the automatic inverter switch at inverter side is closed. In the case of overload (the overload delay time expires) or inverter failure, the automatic inverter switch is opened, and the 'Static Switch' module will automatically transfer the loads to the bypass.

In normal operating state, to realize the uninterrupted transfer between inverter and bypass, the inverter output must be synchronized with the bypass.

Therefore, when the bypass frequency is within the synchronization range, the inverter control circuit will synchronize the inverter output frequency with the bypass frequency and phase.

Besides, the UPS has a manual maintenance bypass switch for shutdown of the UPS upon maintenance. In this situation, the bypass will directly supply the critical loads through the maintenance bypass.



### Note

When the load is supplied by the bypass or maintenance bypass, the power supply quality will be uncertain.

## 1.2.3 System Control Principle

### Normal operation

Normal mode: It means that the UPS has normal input mains, the rectifier and inverter operate normally, the load is supplied by the inverter, the battery circuit breaker is closed, and the battery is in stable floating charge state.

**(Parallel System)** Note: As the UPS single module outputs are connected in parallel, the system checks that the inverter control circuits are perfectly synchronized with one another and with the bypass in terms of both frequency and phase, and that they have the same output voltages. Current supplied to the load is automatically divided among UPSs. A warning message appears while synchronization is in progress.

### Mains abnormal

When the mains fails or is abnormal, the rectifier will stop working automatically, and the system will transfer to battery output (through inverter). The length of the operation time in battery mode depends on the load and the battery capacity. During this period, if the battery voltage falls to the EOD voltage and the mains still has not been recovered, the inverter will stop working automatically, and the UPS operator control and display panel will display corresponding alarm messages. If the system uses split bypass configuration and the bypass is normal, the system will transfer to bypass.

### Mains recovery

When the mains resumes normal within allowable time, the rectifier will start automatically and supply the load and charge the battery again. Therefore, the power supply to the load will not be interrupted.

### Battery disconnection

To disconnect the external battery from the UPS system for maintenance, use the external isolating switch. At this time, except for the battery backup function upon mains failure, other functions and all the steady state performance of the UPS will not be affected.

### UPS module failure

In case of inverter failure and output fuse blowout, the load will automatically transfer to the bypass, and the output power supply will not be interrupted. In this situation, please contact the local customer service center of Vertiv Tech Co., Ltd for technical support.



**(Parallel System)** In the event of a fault in a UPS module, it will automatically exit from the parallel system. If the system is still capable of providing the required load, the remaining modules will continue to supply the load with no interruption. If the remaining modules are no longer capable of fulfilling the power requirements, the load will automatically transfer to the bypass.

### Overload

If the inverter is overloaded or the inverter current remains outside the specifications (refer to Table 11-6) longer than the specified time, the load will automatically transfer to the bypass without power interruption. If both the overload and the current are reduced to a level within the specified range, then the load will be transferred back to the inverter. In case of output short circuit, the load will be transferred to the bypass, and the inverter will shut down. Five minutes later, the inverter will start up automatically. If the short circuit is removed at this point, the load will be transferred back to the inverter. The transfer is determined first of all by the features of the protective device of the system.

In the above two situations, the UPS operator control and display panel will display alarm messages.

**(Parallel System)** The control logic system constantly monitors load requirements and controls the power supplied by each UPS module. In the event that an overload condition is sustained for greater than a preset time, the load will transfer to the bypass, when the number of active modules is unable to satisfy load requirements. The load returns to the inverter if the power is reduced to a value that can be sustained by the number of active modules in the system.

### Maintenance bypass

The UPS has a second bypass circuit, i.e. maintenance bypass, which provides a safe working environment for the engineers to provide regular maintenance or repair to the UPS system and at the same time provide unregulated mains supply to the loads. The maintenance bypass can be manually selected through the maintenance bypass switch, and it can be disconnected by turning the switch to OFF.



Warning

If the UPS system is composed of two or more UPS modules, and when the load capacity exceeds the single module capacity, do not use the internal maintenance bypass switch.

## 1.2.4 UPS Power Supply Switch Configuration

The UPS has four switches: rectifier input switch Q1, bypass input switch Q2, maintenance bypass switch Q3, and output switch Q5. **Note that switches Q1, Q2, and Q5 are optional.**

Figure 1-2 describes the block diagram of the UPS module. The UPS has split bypass configuration (that is, the bypass adopts independent mains input) and common input configuration. If the system adopts common input configuration, the UPS has shorting copper bar of common input configuration, and the bypass input switch (Q2) and rectifier input switch (Q1) would be linked together. If the system adopts split bypass configuration, just remove the shorting copper bar of common input configuration of the UPS.

During the normal operation of the UPS, except for the maintenance bypass switch Q3, other switches shall be closed.

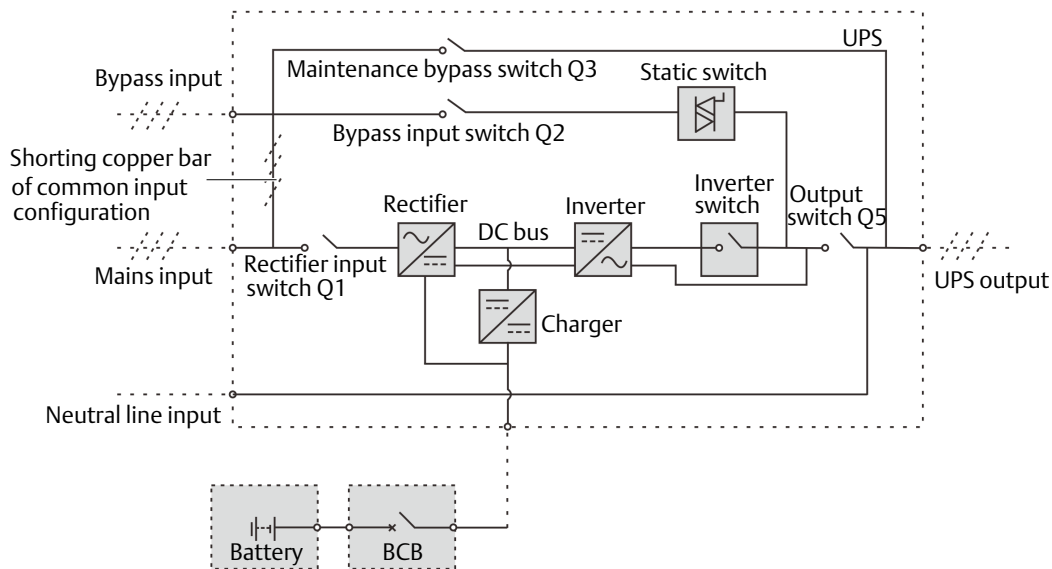

Note: Q1, Q2 and Q5 are optional while Q3 is standard.

Figure 1-2 UPS power supply switch configuration

Note: The mains input and bypass input share the same neutral line.

### 1.2.5 Battery Circuit Breaker (BCB)

The external battery shall be connected to the UPS through the BCB. The BCB box is an option, which shall be installed near the battery. The BCB is closed manually. The BCB has a shunt tripping coil. When the system is faulty and the BCB needs to be disconnected, the UPS control circuit will send a signal to the shunt tripping coil so as to trip the BCB. It also has a magnetic trip facility for overload protection and short circuit protection.

## 1.3 Parallel System

Up to four UPS modules can be parallel-connected to form a parallel system to increase the system capacity and reliability. The load is equally shared between the paralleled UPS modules.

Moreover, two UPS modules or parallel system can comprise a dual bus system. Each parallel system has independent output. Output synchronization is achieved through the LBS cable or LBS device, thus enabling seamless load transfer between the two parallel systems or single modules through the STS device.

### 1.3.1 Parallel System Features

1. The hardware and software of parallel system are completely the same as those of the single module. The parallel system configuration is achieved through settings in configuration software.
2. Parallel cables are connected in a ring, providing both system reliability and redundancy.
3. The total load of the parallel system can be queried from each UPS module's TOUCHSCREEN.

### 1.3.2 Parallel System Requirements

A group of paralleled modules behave as if it were one large UPS with the advantage of presenting higher reliability. To ensure that all modules are equally utilised and to comply with relevant wiring rules, the following requirements apply:

1. All UPS modules must be the same series, and connect to the same bypass source.
2. The N line of bypass and rectifier input sources must be connected to the same neutral line terminal.
3. Any RCD, if installed, must be of an appropriate setting and located upstream of the common neutral line input terminal. Alternatively, the device must monitor the protective earth current of the system. Refer to *Warning: high earth leakage current* before *Contents*.
4. For parallel system consists of two or more UPS modules, the bypass load sharing inductors (optional) should be selected.

## 1.4 Operation Modes

The UPS has the following operation modes:

- Normal mode
- Battery mode
- Automatic restart mode
- Bypass mode
- Maintenance mode
- ECO mode
- Parallel redundancy mode (system expansion)
- Frequency converter mode
- LBS mode

### Normal mode

As shown in Figure 1-3, the mains is rectified by the UPS rectifier and then inverted by the inverter to supply uninterrupted AC power to the loads. At the same time, the charger will charge the battery.

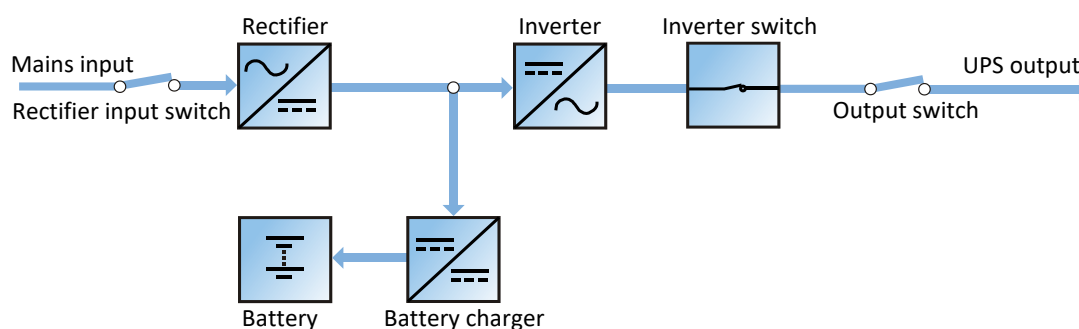

Figure 1-3 Schematic diagram of normal mode

### Battery mode

As shown in Figure 1-4, the operation mode in which the battery provides backup power supply to the loads through the rectifier and inverter is called battery mode. Upon mains failure, the system will automatically transfer to the battery mode with no load power interruption. When the mains is recovered, the system will automatically transfer back to the normal mode without any manual intervention, and the power to the load will not be interrupted.

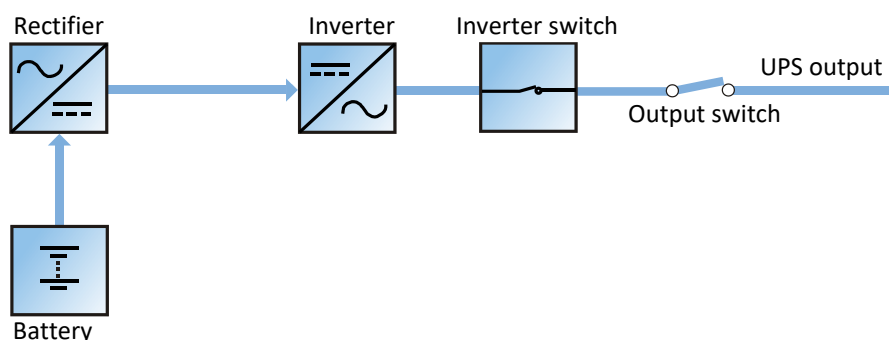

Figure 1-4 Schematic diagram of battery mode

Note: Battery cold start function is available for switching the UPS on from Battery (charged) mode directly during mains failure. Therefore, the battery power supply can be used independently to improve the availability of the UPS.

### Automatic restart mode

The UPS has automatic restart function. When the inverter shuts down because the mains fails and the battery discharges to EOD voltage, if the mains is recovered, the UPS will restart automatically after a certain time of delay. This function and the automatic restart type can be set by the service engineer authorized by Vertiv.

During the process of automatic restart time of delay, the UPS will charge the battery to protect against the power-off risk of the load device caused by mains power failure.

If the automatic restart function has not been set, the user can manually start the UPS through Reset Fault function.

### Bypass mode

As shown in Figure 1-5, in normal mode, in case of an inverter failure, an inverter overload or an inverter manual shutdown, the static switch will transfer the load from the inverter side to bypass side, with no interruption in power to the load. At this time, if the inverter and bypass are not synchronized, the power of the load has transitory interruption, with time of less than 20ms.

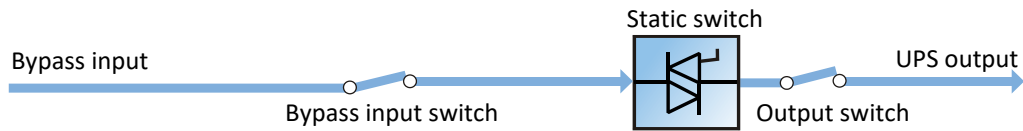

Figure 1-5 Schematic diagram of bypass mode

### Maintenance mode

As shown in Figure 1-6, if the UPS maintenance or service is required, you may use the manual maintenance bypass switch to transfer the load to maintenance bypass, with no interruption in power to the load. This maintenance bypass switch is fitted in all UPS modules and rated for full load of a single module.

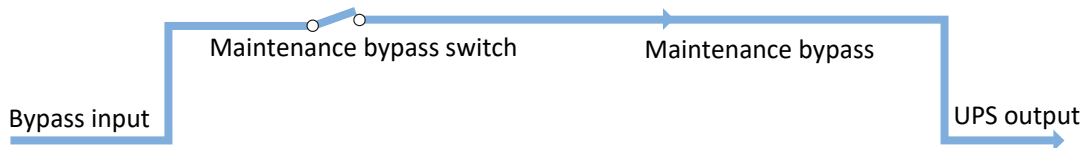

Figure 1-6 Schematic diagram of maintenance mode

### ECO mode

If ECO mode is selected, all power switches and the battery switches are closed except for the maintenance bypass switch, and the system prefers to put the load on the bypass, to achieve the aim of energy-saving. When the bypass supply is within the range of normal frequency and normal voltage (adjustable), the load is powered by the bypass, with the inverter on stand-by; when the voltage and/or frequency of the bypass supply are beyond the pre-defined and adjustable limits, the system will transfer to the inverter output, and the transfer time for switching from bypass to inverter is less than 2ms (uninterrupted) and less than 5ms (interrupted). In this mode, the system can normally charge the battery.

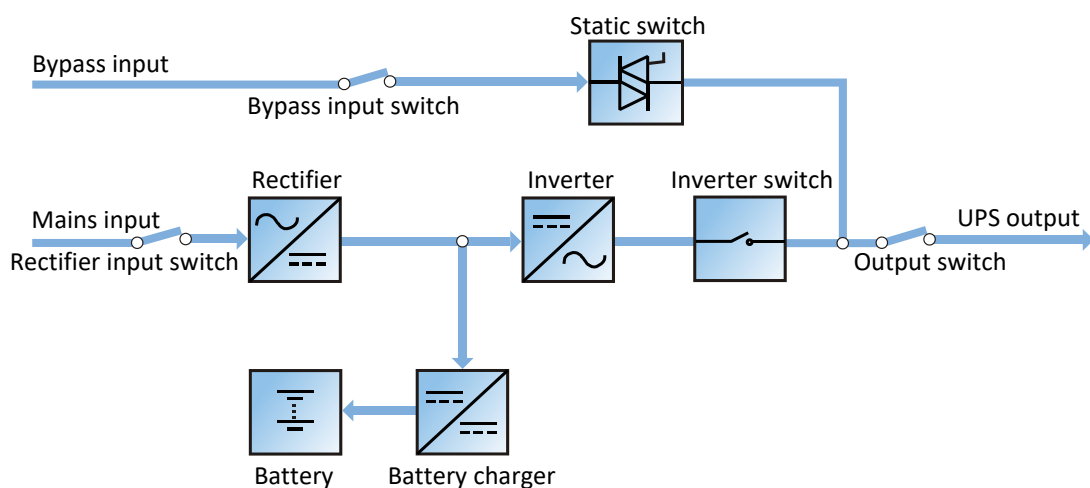

Figure 1-7 Schematic diagram of ECO mode

If ECO mode is required, adjust corresponding parameters through the operator control and display panel.

The operation method of ECO mode is the same as the description in *Chapter 5 UPS Operation Introduction*. However, in normal mode, the load is powered by the bypass, the TOUCHSCREEN displays 'Bypass mode', and the transfer time for switching from bypass to inverter is less than 2ms (uninterrupted) and less than 5ms (interrupted).

**Warning**

In ECO mode, the load is not protected against mains distortion.

### Parallel redundancy mode (system expansion)

For higher capacity or higher reliability, the outputs of multiple UPS modules can be programmed for directly paralleling while a built-in parallel controller in each UPS module ensures automatic load sharing. The parallel system can be composed of up to four UPS modules. For the operation principle diagram of the parallel redundancy mode, see Figure 7-1.

### Frequency converter mode

The UPS can be programmed into frequency converter mode for either 50Hz or 60Hz stable output frequency. The input frequency may vary from 40Hz to 70Hz. Under this mode, it is required to open the maintenance bypass switch to disable the static bypass operation, and the battery becomes optional depending on any requirement to operate in battery mode.

### LBS mode

A dual bus system consists of two independent UPS systems, each containing one or more parallel UPS modules. The dual bus system has high reliability and is applicable to the load with multiple inputs. For single-input load, an STS can be installed to power the load. For the operation principle diagram of the LBS mode, see Figure 7-5 and Figure 7-6.

## 1.5 Battery Management

The following battery management functions are set by the service engineer through the Vertiv setting software.

### 1.5.1 Normal Function

#### 1. Constant current boost charge

Adopt the constant current (within battery charging limit) to charge the battery. The function can be used for battery capacity fast recovery. The charge current can be set.

#### 2. Constant voltage boost charge

Adopt the constant voltage to charge battery. The function can be used for battery capacity fast recovery. For VRLA batteries, the maximum boost charge voltage should not exceed 2.4V/cell.

#### 3. Float charge

The charging method is used for keeping battery with a full capacity. The float charge voltage is generally low. The function can balance the capacity loss due to battery self discharging, and can be used for battery capacity recovery.

For VRLA batteries, the float charge voltage should be between 2.2V/cell and 2.3V/cell.

#### 4. Automatic transfer to float charge

When the charge current is less than 'Threshold of Equalize Charge to Float Charge' or 0.5A, the charger will automatically transfer from boost charge to float charge. When boost charge time exceeds the limit of 'Equalize Charge Protect Time Limit', the charger will be forcibly transferred to float charge for protecting the battery.

#### 5. Float charge temperature compensation (optional)

This function must be used together with the battery temperature detection device. The Vertiv battery temperature sensor is a standard option for your selection.

#### 6. EOD protection

When the battery voltage drops to the EOD voltage, the battery converter shuts down automatically and the battery is inhibited to avoid further battery discharge. The EOD voltage is settable from 1.60V/cell to 1.90V/cell (VRLA).

#### 7. Battery low pre-warning time

The battery low pre-warning time is adjustable between 3min and 60min. The default setting is 5min.

#### 8. Maximum battery discharge time

When the battery has small current discharge for a long time, the battery is over discharged and even has unrecoverable damage, thus setting a battery discharge time to protect the battery is essential. The limit of time setting shall be configured by service engineer through the Vertiv setting software.

#### 9. Maximum boost charge protection time

To protect against the battery overcharge damage caused by long time boost charge, a protect time setting is essential. The limit of time setting shall be configured by service engineer through the Vertiv setting software.

### 1.5.2 Advanced Function

The UPS provides battery maintenance test function. At periodic intervals, 20% of the rated capacity of the battery will be discharged automatically, and the actual three-phase load must exceed 20% of the nominal UPS capacity. If the load is less than 20%, the automatic discharge cannot be executed. The periodic interval can be set from 30 to 360 days. The battery maintenance test function can be disabled through the Vertiv setting software.

**Conditions:** Battery at float charge for at least 5h, load equal to 20% ~ 100% of rated UPS capacity.

**Trigger:** Automatically, or manually through the command of battery maintenance test in TOUCHSCREEN.

**Interval:** 30 ~ 360 days (default setting: 60 days).

The UPS also provides battery capacity self-test function: Periodically test the battery activity, test the battery residual capacity, judge the battery quality, and then provide corresponding measures. The capacity self-test is started by the user through the operator control and display panel. During the capacity self-test, the battery will continuously discharge to the battery undervoltage shutdown threshold. After the self-test is finished, the system will update the battery curve table. The capacity self-test command is valid only one time, without any memory. During the capacity self-test, if the battery maintenance requirement is satisfied, the system will generate audible/visual alarm and give corresponding records.

**Conditions:** System load rate within 20% ~ 100%, battery float charge at least 5h, and generator not connected; the current system is in float charge state.

**Trigger:** Start up through the TOUCHSCREEN.

**Note:**

1. The battery will continuously discharge to the battery undervoltage shutdown threshold, then the battery transfer to the charging state. When the capacity self-test is finished, the system will update the battery curve table.
2. The user can manually stop the capacity self-test operation through the TOUCHSCREEN.

### 1.5.3 Battery Temperature Compensation

The UPS system has battery charge temperature compensation function. When the ambient temperature is increased, the DC bus voltage (which charges the battery) will be reduced correspondingly to provide optimal charging voltage for the battery, thus prolonging the battery service life time.

This function must be used together with the Vertiv battery temperature detection device (a standard option).

## 1.6 Battery Protection

 <b>Warning</b>
The user must select an appropriate MCCB to protect against short circuit and overload for the battery. It is recommended to adopt Vertiv BCB to provide a better solution.

The following battery protection functions are set by the service engineer through the Vertiv setting software.

#### Battery low pre-warning

The battery low pre-warning occurs before the EOD. After this pre-warning, the battery should have the capacity for three remaining minutes discharging with full load. The time can be configured from 3min to 60min.

#### EOD protection

When the battery voltage drops to the EOD voltage, the battery converter shuts down automatically. For VRLA batteries, the EOD voltage is adjustable from 1.60V/cell to 1.90V/cell (VRLA).

#### BCB alarm

The BCB alarm occurs when the external BCB opens, if you select the Vertiv BCB (optional).

The external battery connects to the UPS through the BCB. The BCB is manually closed and tripped by the UPS control circuit.

## Chapter 2 Mechanical Installation

This chapter briefly introduces the mechanical installation of the UPS, including the precautions, initial inspection before installation, environmental requirement, mechanical requirement and installation diagram.

### 2.1 Precautions

This chapter describes the environmental and mechanical requirements and mechanical considerations that must be taken into account when planning the positioning and cabling of the UPS equipment.

Because each site has its particular characteristics, this chapter does not provide the detailed installation steps, it only acts as a guide for the general procedures and practices that should be observed by the installing engineer, so that they can properly handle the specific situation of the site.



**Warning: professional installation required**

1. Do not disassemble the package without permission of authorized service engineer.
2. The UPS should be installed by an authorized engineer in accordance with the information contained in this chapter.



**Warning**

The UPS can be connected to IT, TN and TT AC distribution systems (IEC60364-3), and must be of 3-phase 5-wire (A, B, C, N, PE) system.



**Warning: battery danger**

Take special care when installing batteries. When connecting batteries, the battery terminal voltage will reach 320Vdc, which is fatal to human being.

1. Please wear safety glasses to protect the eyes from being damaged by arc.
2. Remove all the metal items, including finger rings, watch, etc.
3. Use tools with insulated handle.
4. Wear rubber gloves.
5. If the battery has electrolyte leakage or the battery is damaged, it must be replaced. Place the battery into the container that can withstand sulfuric acid and dispose of it according to the local regulations.
6. If the skin contacts the electrolyte, flush it with water immediately.

### 2.2 Transportation

Railroad transportation and shipping are the recommended means of transportation. If truck transportation is unavoidable, choose roads that are less bumpy in order to protect the equipment.

The UPS cabinet is heavy (see Table 11-3 for its weight). It is recommended to use mechanical equipment such as an electric forklift to unload and move the equipment to the place closest to the installation site. If an electric forklift is used, insert the tines of the forklift below the bottom pallet (as shown in Figure 2-1) to prevent the equipment from falling over.



Figure 2-1 Inserting and movement



## 2.3 Tools





















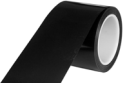

 <b>Warning</b>
<p>1. For the sake of safety, the installation tools under live operation must be insulated.</p> <p>2. Tools in Table 2-1 are for reference only; please follow the actual requirement for on-site installation and connection.</p>

Table 2-1 Tools

Name	Drawing	Name	Drawing
Electric hand drill		Adjustable wrench	
Slotted screwdriver		Cross head screwdriver	
Stepladder		Forklift	
Drill		Wire cutting plier	
Claw hammer		Diagonal cutting plier	
Insulating shoes		Antistatic gloves	
Electrician knife		Cable tie	
Insulating tape		Insulating gloves	
Crimping plier		Heat shrinkable tube	
Insulated torque wrench		Torque screwdriver	
Multimeter		Clip-on ammeter	

## 2.4 Unpacking

Unpack the UPS and battery packages under the guidance of authorized service engineer. Steps:

1. Remove the packing belt.

Use a cutting plier to cut off the packing belt, as shown in Figure 2-2.



Figure 2-2 Packing belt

As shown in Figure 2-3, remove the top cover and carton box.



Figure 2-3 Removing top cover and carton box

2. As shown in Figure 2-4, remove the honey comb plate.



Figure 2-4 Removing honey comb plate

3. Open the front door of the UPS, loosen the fixing screws and remove the bottom fixed part at front of the cabinet. Then loosen the fixing screws and remove the bottom fixed part at back of the cabinet. As shown in Figure 2-5.

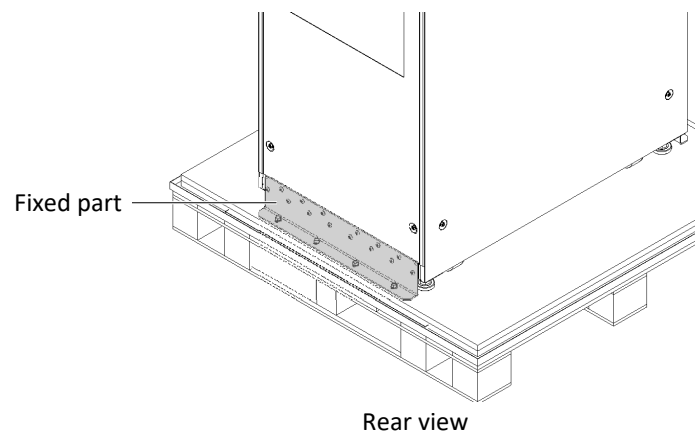

Figure 2-5 Removing bottom fixed part

4. Refer to Figure 2-6, install the decorative plate at the position of the removed fixed part.

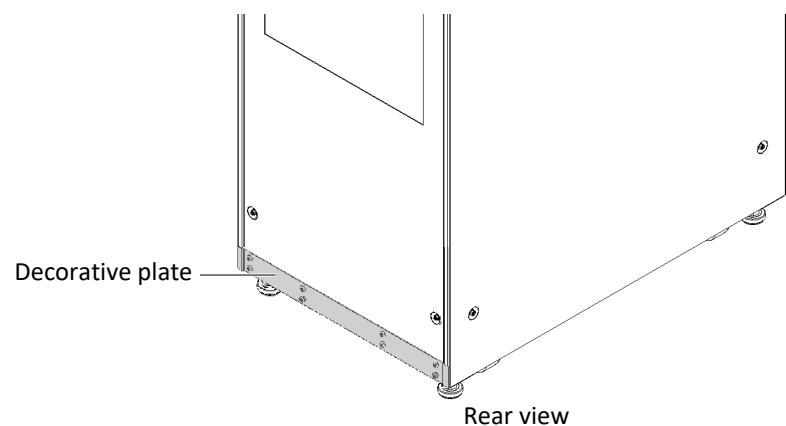

Figure 2-6 Installing decorative plate

5. Raise the four feet, push down the cabinet along the slide board and move it to its installation position. Then lower the four feet to fix the cabinet.

## 2.5 Initial Inspection

Before installing the UPS, carry out the following inspections:

1. Ensure that the environment of the UPS equipment room meets the environmental requirement specified in the product technical specifications, especially the ambient temperature, ventilation conditions, and the dust situations.
2. Unpack the UPS and battery under the guidance of authorized service engineer. Visually inspect whether the UPS and battery have any transportation damage. If there is any damage, report to the carrier immediately.
3. Verify the UPS label and confirm the correctness of the UPS. The UPS label is attached on the back of the door. The model, capacity and main parameters of the UPS are marked on the label.

## 2.6 Environmental Requirement

### 2.6.1 UPS Location Selection

The UPS should be located in a cool, dry, clean-air indoor environment with adequate ventilation, and should be located on concrete or other nonflammable and flat surfaces. The ambient environment should be free of conductive powder (such as metallic powder, sulfide, sulfur dioxide, graphite, carbon fiber, conductive fiber, etc.), acid mist or other conductive media (strongly ionized substances). The environment specifications should comply with relevant international standard & specifications and the operating range (see Table 11-2) specified in this manual.

The UPS uses forced cooling by internal fans. Cooling air enters the UPS through the ventilation grills at the front of the cabinet and exhausted through the ventilation grills at the back of the cabinet. Do not obstruct the ventilation holes (ventilation grills). The rear of the UPS should be kept a distance at least 500mm from the wall to avoid blocking the UPS heat dissipation, thus reducing the UPS internal temperature and improving the UPS life.

If necessary, install indoor extractor fans to aid cooling-air flow to avoid room temperature buildup. Air filters (optional) should be used when the UPS is to operate in a dirty environment.

**Note 1: When the battery cabinet is installed near the UPS, the maximum allowable ambient temperature is dependent on the battery rather than the UPS.**

**Note 2: If the UPS is working in ECO mode, the power consumption will be less than that in Normal mode. Proper air conditioning system shall be selected according to the normal operating mode.**

### 2.6.2 Battery Location Selection

Batteries generate some amount of hydrogen and oxygen at the end of charge, so the fresh air volume of the battery installation environment must meet the EN50272-2001 requirements.

The ambient temperature is the main factor that affects the battery capacity and life. The normal operating temperature of the battery is 20°C. If the ambient temperature is higher than 20°C, the battery life will be reduced. If it is lower than 20°C, the battery capacity will be reduced. In normal situation, the allowable ambient temperature for the battery is 15°C to 25°C. The ambient temperature of the battery shall be maintained constant, and the battery shall be kept away from heat source and air outlet.

Battery can be installed inside the specialized battery cabinet which shall be close to the UPS. If the battery is placed on the raised floor, bracket shall be installed under the floor, just as for the UPS. If the battery adopts rack mounting or is mounted far from the UPS with other installation mode, the battery circuit breaker shall be installed near the battery, and the cabling distance shall be minimized.

### 2.6.3 Storage

Should the UPS not be installed immediately, it must be stored with the original packaging in a room for protection against excessive humidity and heat sources (see Table 11-2). The battery needs to be stored in a dry and cool place with good ventilation. The most suitable storage temperature ranges from 20°C to 25°C.

**Warning**

During battery storage, periodically charge the battery according to the battery manufacturer instructions. In the charge process, temporarily connect the UPS to the mains and activate the battery by recharging the battery.

## 2.7 Mechanical Requirement

### 2.7.1 Composition

As a cabinet of 600mm width, the 80kVA ~ 120kVA system provides the options such as rectifier input switch, bypass input switch, and output switch.

As a cabinet of 600mm width, the 160kVA ~ 200kVA system also provides the optional switch cabinet (width: 400mm) which contains the rectifier input switch, bypass input switch, output switch and maintenance switch.

### 2.7.2 Moving Cabinet

**Warning**

1. The lifting equipment for moving the UPS cabinet must have enough lift capacity.
2. The UPS has installed castors. When removing the UPS from the shipping pallet, pay attention to keeping the UPS from sliding. Ensure that adequate personnel and lifting equipment are available when removing the shipping pallet.
3. Due to its intensity, the castor may not be valid on the uneven surface.
4. The center of gravity of the UPS cabinet is high; avoid falling over during the cabinet movement.
5. Vertical hanging of cabinet is not allowed.

Ensure that the weight of the UPS does not exceed the capacity of the lifting equipment. For the UPS weight, refer to Table 11-3.

The UPS cabinet can be moved by forklift or other similar lifting equipment.

For short distance movement, the castors can be used.

### 2.7.3 Clearance

Because the UPS has no grille at the two sides, there is no special clearance requirement on the two sides.

Besides the local regulations, to enable routine tightening of the power terminals within the UPS, it is recommended that clearance around the front of the UPS should be sufficient to enable free passage of personnel with the door fully open. Meanwhile, maintain at the back of the cabinet a clearance at least 500mm to permit adequate circulation of air coming out of the UPS.

### 2.7.4 Cable Access Mode

The UPS adopts top cable access method and bottom cable access method.

For further description, refer to 3.1.10 *Power Cable Connection Steps* and 3.2.10 *Signal Cable Connection Steps*.

## 2.8 Installation Drawings

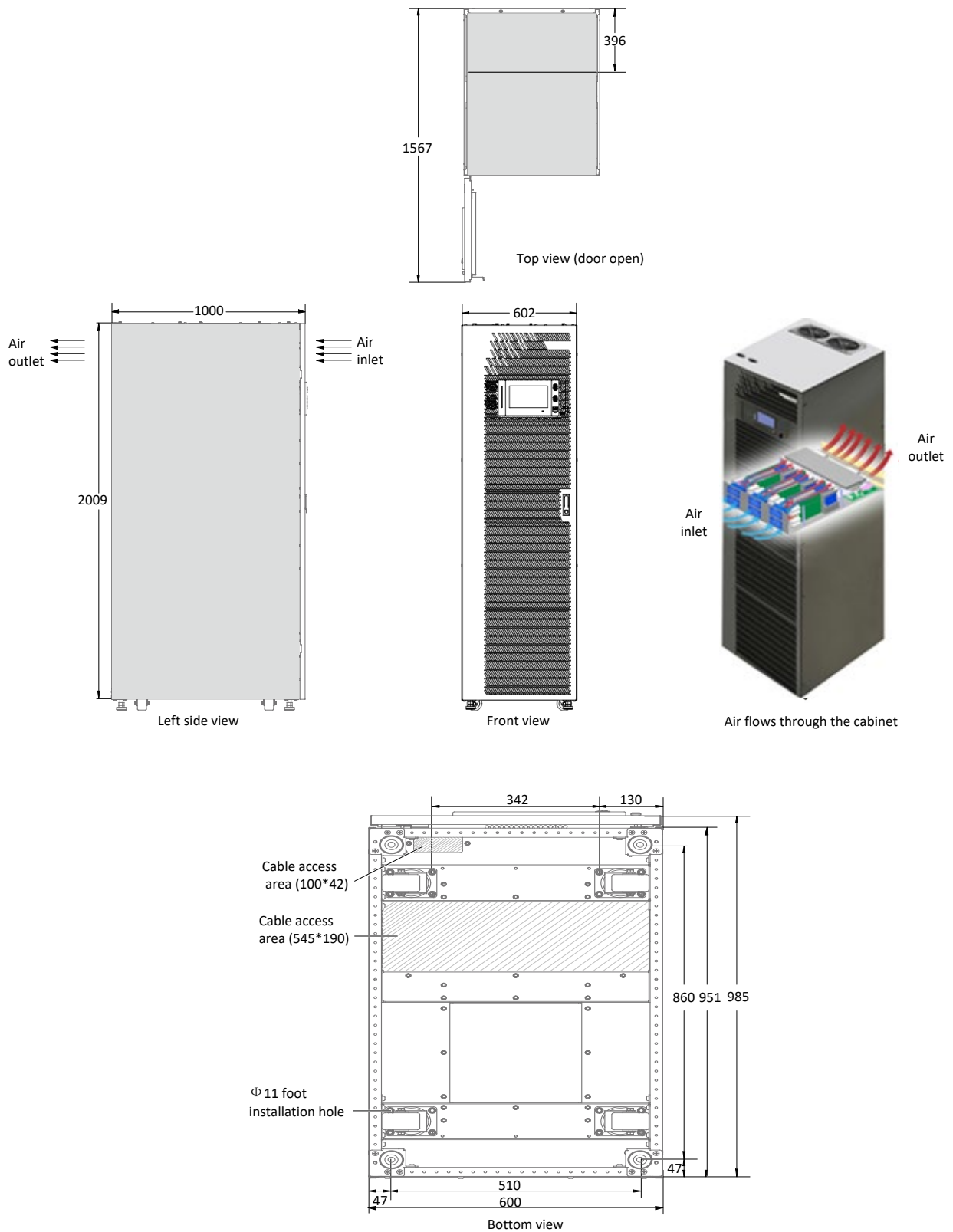

Figure 2-7 Top/front/side/bottom view of the 80kVA ~ 200kVA UPS (unit: mm)

## Chapter 3 Electrical Installation

This chapter mainly introduces the electrical installation of the UPS, including the power cable and signal cable connecting procedures and methods.

After completing the mechanical installation of the UPS, it is required to connect the power cable and signal cable of the UPS. All the signal cables, whether shielded or not, shall be kept away from the power cables.



**Warning**

1. Do not power on the UPS before the arrival of authorized service engineer.
2. The UPS cables should be routed by an authorized engineer in accordance with the information contained in this chapter.

### 3.1 Wiring Of Power Cable

#### 3.1.1 System Configuration

The cable size of the system power cable shall meet the following requirements:

##### UPS input cable

The cable size of the UPS input cable differs with the UPS power ratings and input AC voltages, provided that it meets the requirement of maximum input current, including the maximum battery charge current, see Table 3-1.

##### UPS bypass and output cable

The cable size of the UPS bypass and output cable differs with the UPS power rating and output AC voltages, provided that it meets the requirement of nominal output or bypass current, as shown in Table 3-1.

##### Battery cable

Each UPS connects to its battery through the three cables connecting to the positive pole, negative pole and neutral line. The cable size of the battery cable differs with the UPS power ratings, provided that it meets the battery discharge current requirement when the battery discharges to near EOD voltage, as shown in Table 3-1.

#### 3.1.2 Maximum Steady State AC And DC Currents

The power cable must be selected according to the current and voltage values in Table 3-1 as well as the local wiring regulations, and take environmental conditions (temperature and physical media) into consideration, then refer to Table 3B in IEC 60950-1.

Table 3-1 Max. steady state AC and DC currents

UPS power (kVA)	Rated current (A)				Bus stud bolt/nut specification		
	Max. input current <sup>12</sup>	Output/bypass current <sup>2</sup> at full load			Battery discharge current (+, -, N) at min. battery voltage	Input/battery/output/bypass/PE cable	Recommended torque (N.m)
		380V	400V	415V			
80kVA	163	121	116	111	292	M10	22±10%
100kVA	204	152	145	139	365	M10	22±10%
120kVA	245	182	174	167	439	M10	22±10%
160kVA	356	242	232	222	585	M10	22±10%
200kVA	408	303	290	278	731	M10	22±10%



**Note**

1. Max. input current is calculated according to the low voltage input of 176V and 100% load percentage.
2. Max. output/bypass current is calculated according to the rated voltage and 100% load percentage.

3. The battery discharge current at the lowest battery voltage is calculated according to the battery cell number of 30 and lowest EOD voltage of 1.6V.

### 3.1.3 Recommended CSA Of UPS Cable

The recommended CSA of the UPS cable is listed in Table 3-2.

Table 3-2 Recommended CSA of the UPS cable (unit: mm<sup>2</sup>, ambient temperature: 25°C)

Model	Input	Output	Bypass	Neutral line	Earth cable	Battery
80kVA	50	35	35	50	25	See Table 6-4
100kVA	70	50	50	70	35	See Table 6-4
120kVA	95	70	70	95	50	See Table 6-4
160kVA	2*50	95	95	2*50	50	See Table 6-4
200kVA	2*70	2*50	2*50	2*70	70	See Table 6-4

### 3.1.4 Selection Of UPS I/O And Battery Switch

The user can select the switch according to actual needs. Refer to Table 3-1 for I/O current and battery current value.

### 3.1.5 Distance Between The UPS Connection Point And The Floor

Table 3-3 Min. distance between UPS connection point and floor

UPS connection point	Min. distance (mm)	
	80kVA ~ 120kVA	160kVA ~ 200kVA
Rectifier input	350	294
Bypass input	431	385
AC Output	383	294
Battery supply	387	321
PE terminal	506	370

### 3.1.6 Notes

The following points are for general guidance only. If there are relevant local regulations, the local regulations shall prevail.

1. The cable size of the protective earth cable shall be selected according to the AC power failure level, cable length and protection type. The grounding wire connection must use the shortest connection route.
2. For the cables with large current, parallel connection of small cables can be adopted to facilitate the installation.
3. When selecting the battery cable size, the current value in Table 3-1 shall be referred to, and a maximum voltage drop of 4Vdc is allowed.
4. Do not form coils, so as to minimize the formation of EMI.

### 3.1.7 Power Cable Connecting Terminal

The rectifier input, bypass input, output and battery power cables are connected to the corresponding terminals shown in Figure 3-2.

### 3.1.8 Protection Ground

The protective earth cable is reliably connected to the PE input terminal (see Figure 3-2) via the fixing bolt. All the cabinets and cable troughs shall be grounded according to the local regulations. The grounding wires shall be tied up reliably to prevent the loosening of the grounding wire tightening screws when the grounding wires are pulled.



**Warning**

Failure to ground as required may cause EMI, electric shock or fire risk.



### 3.1.9 External Protective Device

To ensure the safety, it is necessary to install external circuit breaker for the input and battery of the UPS. Because of the difference of the specific installations, this section only provides general practical information for the installation engineer. The qualified installation engineer should have the knowledge of the local wiring regulations on the equipment to be installed.

#### Input power supply of rectifier and bypass

##### 1. Input overcurrent and short circuit protection

Install suitable protective devices in the distribution line of the incoming mains supply. The protective devices should provide functions such as the overcurrent protection, short circuit protection, isolation protection and tripping upon backfeed. When selecting the protective devices, consider the power cable current-carrying capacity, system overload capacity (see Table 11-6 and Table 11-7) and the short circuit capability of the upstream power distribution.

##### 2. Split bypass configuration

If the UPS adopts split bypass configuration, independent protective device shall be installed respectively on the rectifier input and bypass input distribution lines.



#### Note

1. The rectifier input and bypass input must use the same neutral line.
2. For IT grid system, 4-pole protective components must be installed for the UPS external input power distribution.

##### 3. Ground fault protection

If the pre-stage input power supply has an RCD, the transient state and steady state ground leakage current upon the startup of the UPS shall be considered.

The RCCB shall meet the following requirements:

- Be sensitive to the DC unidirectional pulse (class A) of the whole distribution network
- Be insensitive to transient state current pulse
- Have an average sensitivity which is 0.3A ~ 3A adjustable

The RCCB symbols are shown in Figure 3-1.

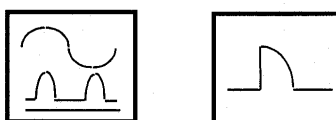

Figure 3-1 RCCB symbols

The UPS has an internal EMC filter, therefore the protective earth cable has leakage current which is less than 3000mA. It is recommended to confirm the RCD sensitivity of the upstream input distribution and the downstream distribution (to the load).

#### External battery

The BCB must be installed for protecting the external battery. The UPS provides an optional BCB box to provide overcurrent protection, short circuit protection and automatic tripping functions for the external battery.

This BCB is important for the battery maintenance, and is generally installed near the battery.

#### System output

The UPS output distribution shall be configured with a protective device. The protective device shall be different from the input distribution protection switch and able to provide overload protection (refer to Table 11-6 and Table 11-7).



#### Note

- For IT grid system, 4-pole protective components must be installed for the UPS external input power distribution.

### 3.1.10 Power Cable Connection Steps

For cable access mode of the UPS, refer to 2.7.4 *Cable Access Mode*.

#### Connection terminal and cable routing method

Figure 3-2 shows the connection terminals of the UPS power cable. Figure 3-3 to Figure 3-5 show the power cable entry and routing methods.



#### Note

1. The power cables should be routed through tunnels or cable troughs to prevent cable damage due to mechanical stress.
2. When routing the cables inside the cabinets, it is required to bind and fix the cables as instructed in Figure 3-3 to Figure 3-5 in the cabinets, so as to prevent cable damage due to mechanical stress.

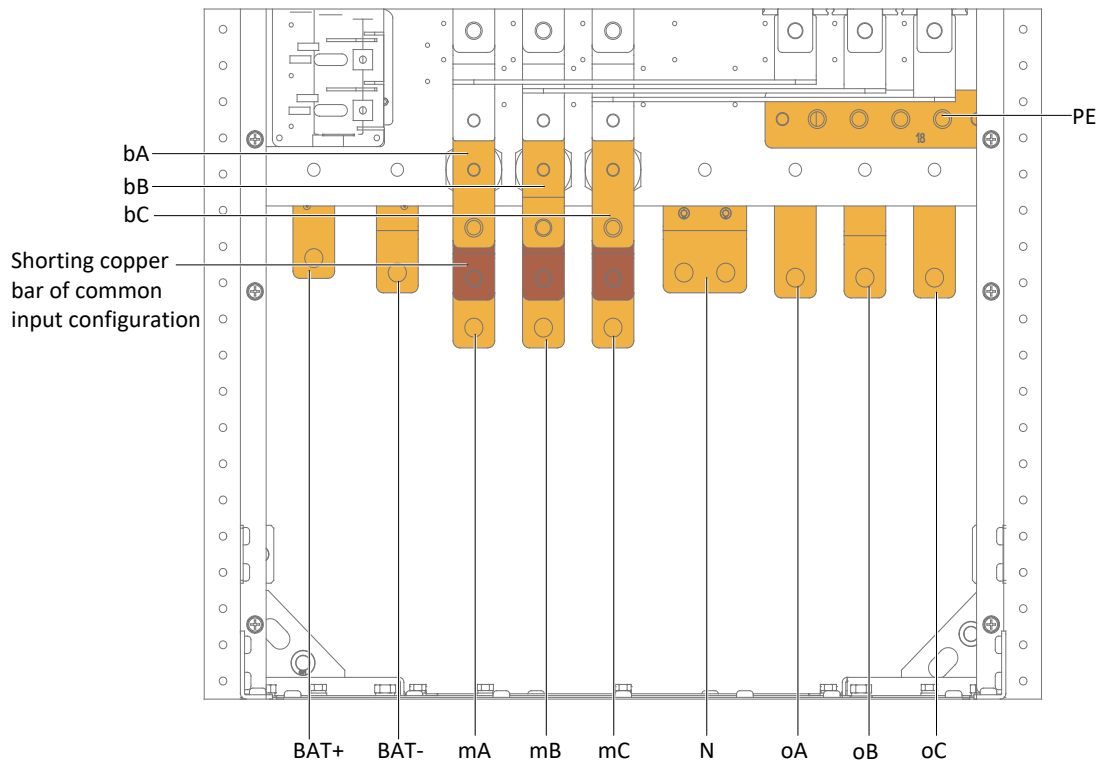

#### Note:

1. BAT+, BAT-: Battery input terminals
2. mA, mB, mC: Mains input terminals
3. bA, bB, bC: Bypass input terminals
4. oA, oB, oC: Output terminals
5. PE: Protective earth
6. N: Neutral line terminal of input, output and battery

*Power cable connection terminals of 80kVA ~ 120kVA UPS*

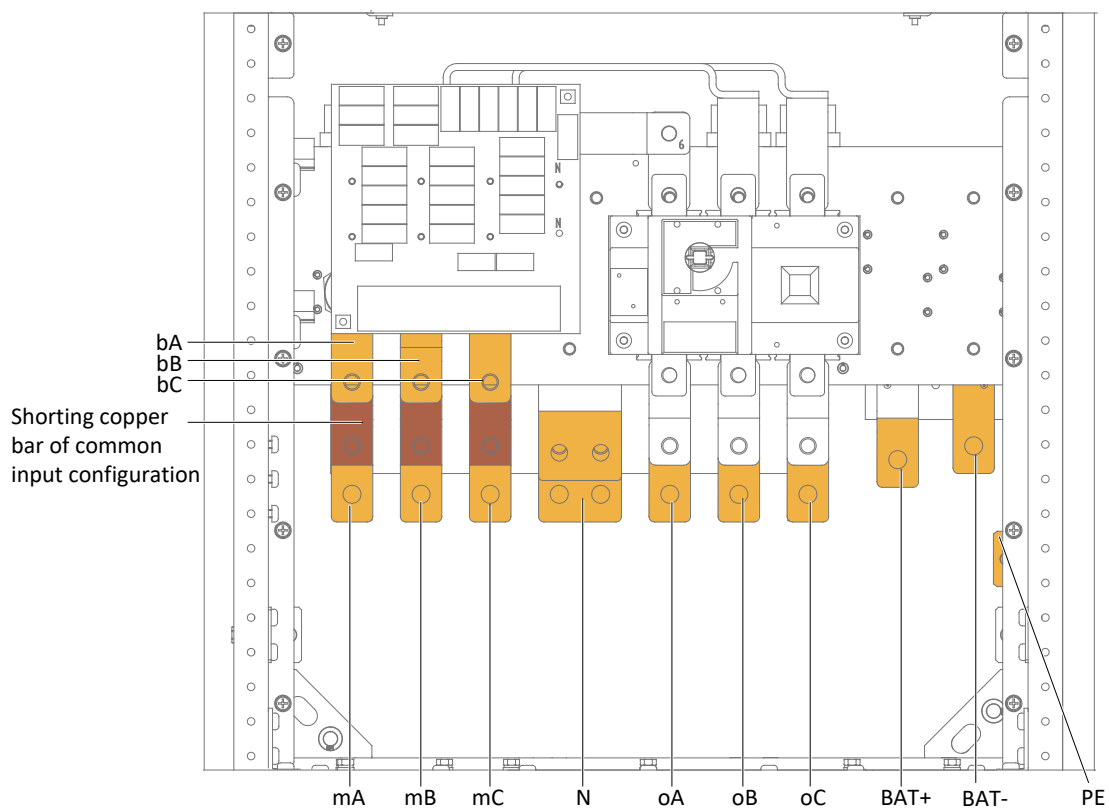
**Note:**

1. BAT+, BAT-: Battery input terminals
2. mA, mB, mC: Mains input terminals
3. bA, bB, bC: Bypass input terminals
4. oA, oB, oC: Output terminals
5. PE: Protective earth
6. N: Neutral line terminal of input, output and battery

*Power cable connection terminals of 160kVA ~ 200kVA UPS*

*Figure 3-2 Power cable connection terminals*

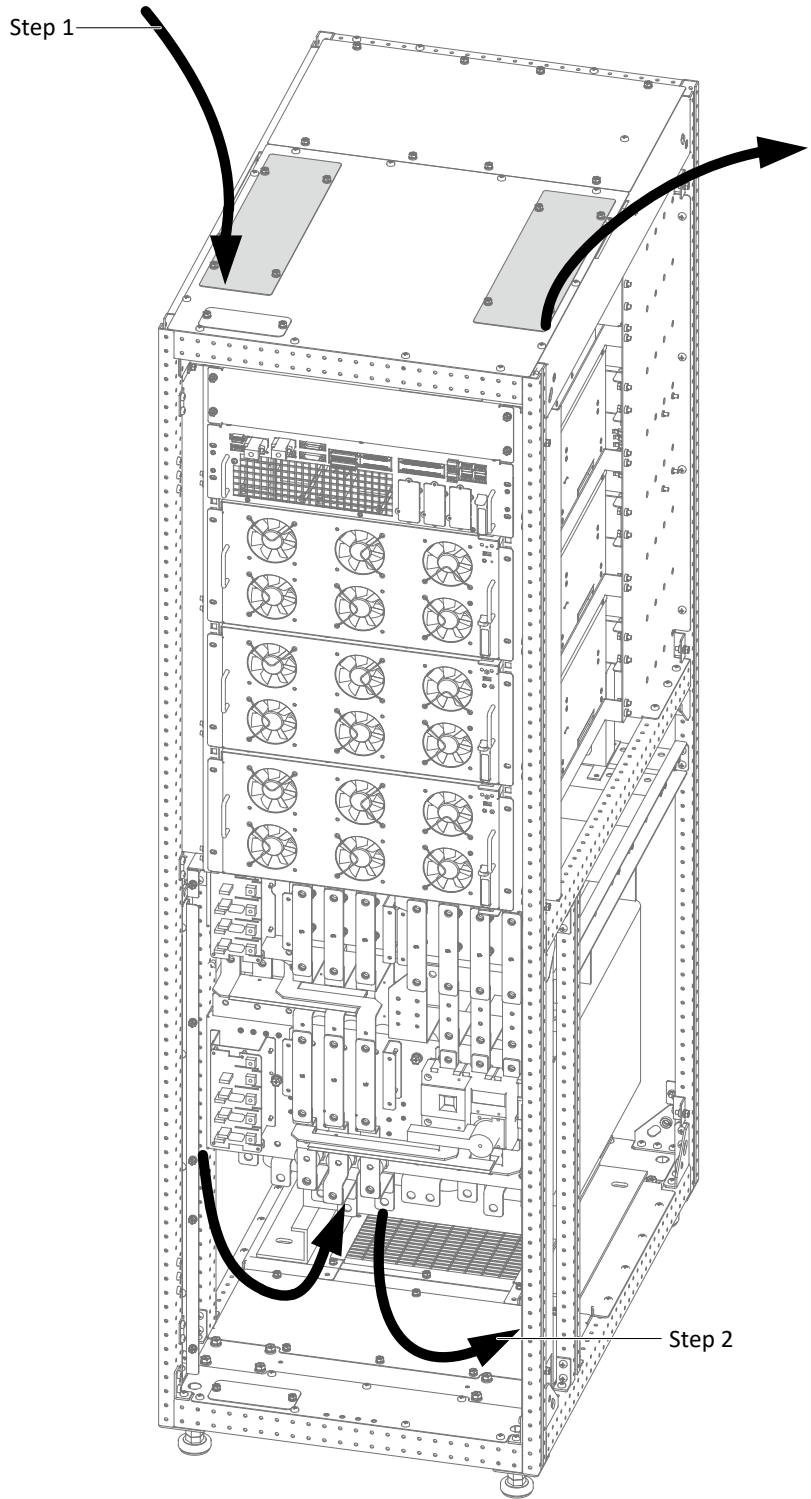

**Note:**

- Step 1: Remove the left top cover, make holes according to the cables number and size, and lead cables from mains, bypass, and PE into the cabinet through the holes, then connect them to corresponding terminals.
- Step 2: Remove the right top cover, make holes according to the cables number and size, then lead the battery cables and output cables from corresponding terminals out of the cabinet.

Figure 3-3 Power cables wiring route of 80kVA ~ 120kVA (top cable access)

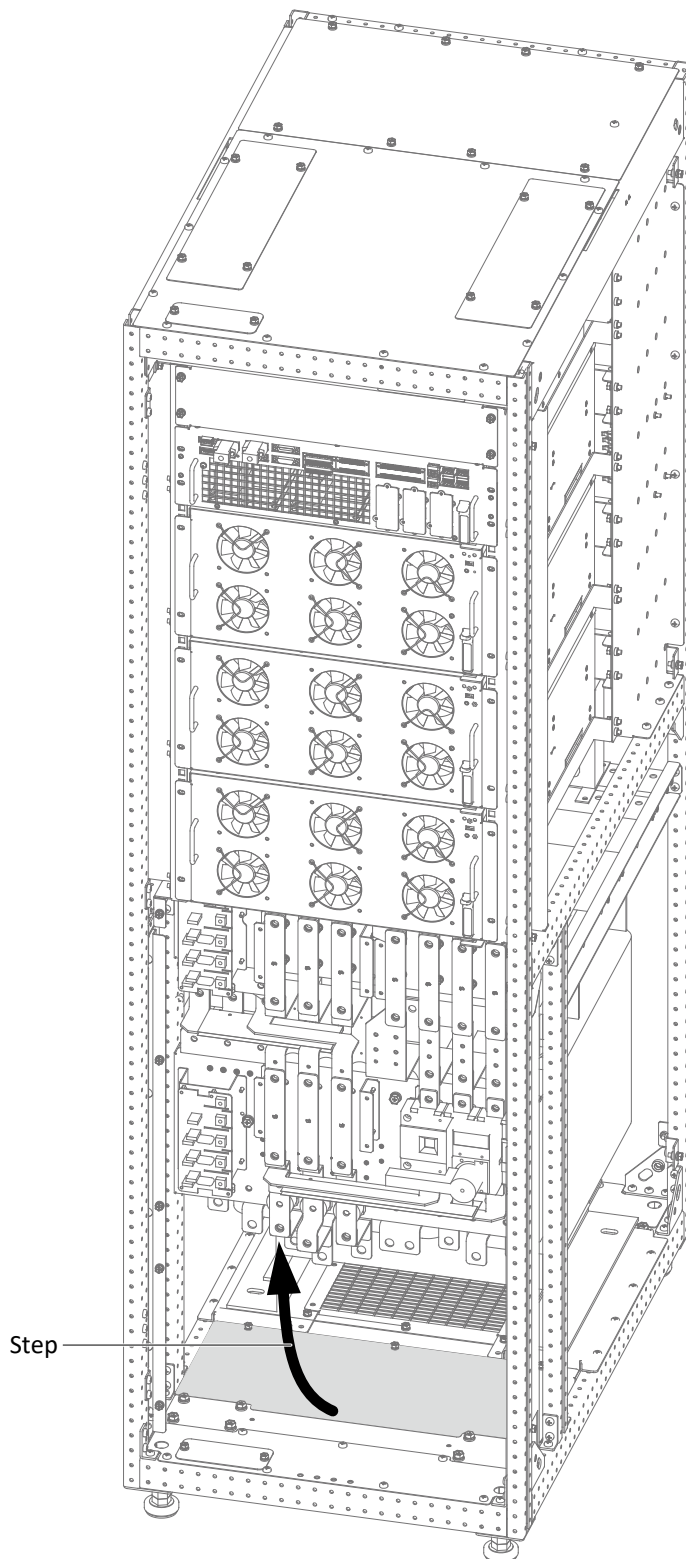

Note:

Step: Remove the bottom plate, make holes according to the cables number and size, and lead cables into the cabinet through the holes, then connect them to corresponding terminals.

Figure 3-4 Power cables wiring route of 80kVA ~ 120kVA (bottom cable access)

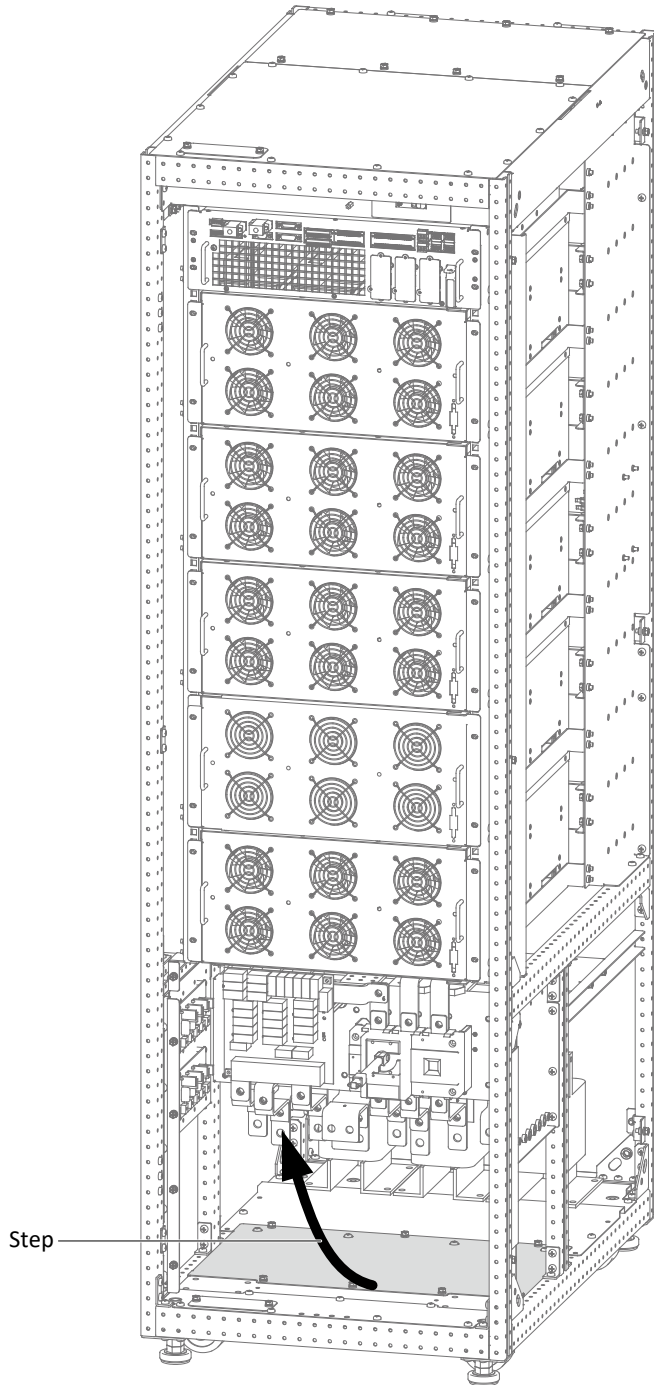

**Note:**  
**Step:** Remove the bottom plate, make holes according to the cables number and size, and lead cables into the cabinet through the holes, then connect them to corresponding terminals.

Figure 3-5 Power cables wiring route of 160kVA ~ 200kVA (bottom cable access)



Before cables connection, make sure that all external and internal power switches of the UPS are off, and post necessary warning signs to prevent inadvertent operation of the switches. Meanwhile, measure the voltages between the UPS terminals and the voltages between the terminals and the earth.

Refer to Figure 3-2 ~ Figure 3-5, open the front door of the UPS to reveal the power cable connection terminals (see Figure 3-2). Connect the protective earth cable to the PE input terminal in the cabinet.

 <b>Warning</b>
<ol style="list-style-type: none"> <li>1. The earth cables and neutral line must be connected in accordance with local and national codes of practice.</li> <li>2. Failure to observe this could result in electric shock or fire risk.</li> </ol>

### Connection of system input

#### 1. Common input configuration

Connect the AC input cables to the bypass input terminals (bA-bB-bC) in the cabinet, and connect the input neutral line to the neutral terminal N in the cabinet. Ensure correct phase rotation.

#### 2. Split bypass configuration

Remove the shorting copper bar of common input configuration, see Figure 3-2. Connect the rectifier input cables to the rectifier input terminals (mA-mB-mC) in the cabinet, and connect the bypass input cables to the bypass input terminals (bA-bB-bC) in the cabinet. Connect the rectifier input neutral line and bypass neutral line to the neutral terminal N in the cabinet. Ensure correct phase rotation.

### Connection of system output

Connect the system output cables between the output terminals (oA-oB-oC-N) in the cabinet and the load. Refer to Table 3-1 for the torque value. Ensure correct phase rotation.

 <b>Warning</b>
<p>If there is no requirement of power supply for the load before arrival of the service engineer, ensure that the system output cables are safely isolated at their ends.</p>

### Connection of batteries

Ensure correct polarity of the connections from the battery string terminals to the BCB and from the BCB to the battery input terminals (BAT+, BAT N, BAT-) in the UPS cabinet, that is, (BAT+) to (+) and (BAT-) to (-), (BAT N) to (N), but disconnect one or more battery cell links in each tier. Do not reconnect these links and do not close the BCB before authorized to do so by the service engineer.

**Note: When connecting the cables between battery terminals and BCB, the connection should begin from the BCB terminal.**

Now the connection is finished.

 <b>Note</b>
<p>After connection, take appropriate measures to seal the cable entry holes.</p>

## 3.2 Wiring Of Signal Cable

### 3.2.1 Overview

For on-site specific needs, the UPS needs auxiliary connection to realize battery system (including the external battery switch) management, communicate with PC, provide alarm signal to external devices, realize remote EPO or provide bypass back feed circuit breaker signal and parallel communication. These functions are realized through the communication box in the UPS cabinet. As shown in Figure 3-6, the communication box provides the following ports.

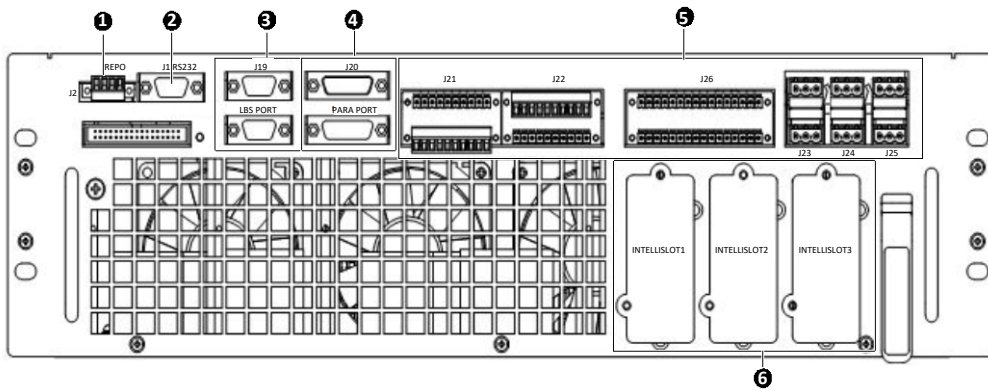

- Note:**
- ① REPO port
  - ② RS232 communication port
  - ③ LBS communication port
  - ④ Parallel communication port
  - ⑤ User dry contact port
  - ⑥ Intellislots

Figure 3-6 Illustration drawing of communication ports

### 3.2.2 Dry Contact Port J21

The dry contact port J21 is shown in Figure 3-7. The port which is only operated by service engineer is used for the configuration of the parallel CAN.

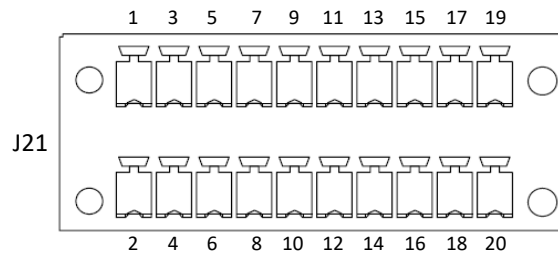

Figure 3-7 Dry contact port J21

### 3.2.3 Dry Contact Port J22

The dry contact port J22 is shown in Figure 3-8 and described in Table 3-4.

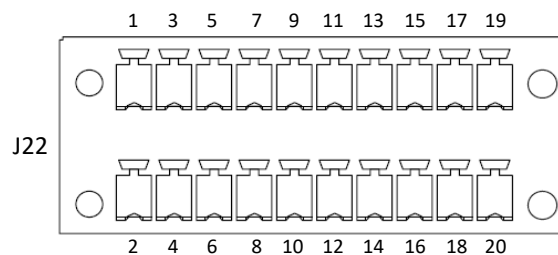

Figure 3-8 Dry contact port J22

Table 3-4 Description of dry contact port J22

Pin	Name	Meanings	Pin	Name	Meanings
1	12V_DRV	BCB driver signal (12V)	2	NA	Not available
3	BCB_STATUS	BCB state signal (24V, 10mA)	4	LIB_ABNOR	Lithium-ion Battery System Abnormal (24V,10mA rated)
5	GND_DRY	Dry ground	6	GND_DRY	Dry ground



Pin	Name	Meanings	Pin	Name	Meanings
7	BCB_ONLine	BCB on line signal	8	LIB_TRIP	Lithium-ion Battery System Trip Request (24V/10mA rated)
9	NA	Not available	10	NA	Not available
11	GND_DRY	Dry ground	12	GND_DRY	Dry ground
13	TMP_BAT	External battery temperature	14	NA	Not available
15	12V_DRY	Power	16	NA	Not available
17	GND_DRY	Dry ground	18	NA	Not available
19	BAT_Ground_FAULT	Battery ground fault (24V, 10mA)	20	NA	Not available

### 3.2.4 Dry Contact Port J26

The dry contact port J26 is shown in Figure 3-9 and described in Table 3-5.

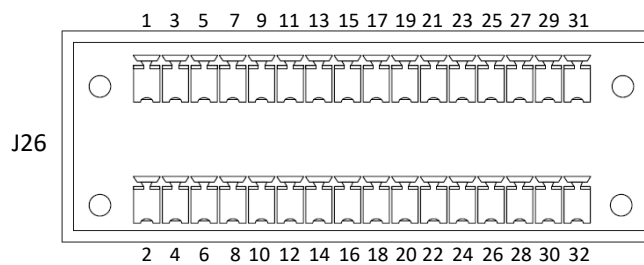

Figure 3-9 Dry contact port J26

Table 3-5 Description of dry contact port J26

Pin	Name	Meanings	Pin	Name	Meanings
1	Q1_STATUS	Input switch status (24V/10mA rated); Pin1/Pin3 shorted for Q1 closed	2	GEN_MODE	Generator mode (24V/10mA rated). Pin2/Pin4 shorted for generator connected
3	GND_DRY		4	GND_DRY	
5	Q2_STATUS	Bypass switch status (24V/10mA rated); Pin5/Pin7 shorted for Q2 closed	6	TMP_BATT_IN	Internal battery temp (analog signal)
7	GND_DRY		8	+12V_DRY	
9	Q3_STATUS	Maintenance switch status (24V/10mA rated); Pin9/Pin11 open for Q3 closed	10	TX_OVCURR	Transformer over current status (24V/10mA rated), pin10/12 shorted for transformer over current
11	GND_DRY		12	GND_DRY	
13	Q5_STATUS	Output switch status (24V/10mA rated); Pin13 /Pin15 shorted for Q5 closed	14	ENV_DET	Battery room temperature status (24V/10mA rated). Pin14/Pin16 shorted for battery room temperature abnormal
15	GND_DRY		16	GND_DRY	
17	GND_DRY	External maintenance isolation switch status (24V/10mA rated); Pin17 /Pin19 open for QOP closed	18	CHG_SHUT	Charger shutdown (24V/10mA rated). Pin18/Pin20 shorted for charger off command
19	QOP_STATUS		20	GND_DRY	
21	QBP_STATUS	External maintenance switch status (24V/10mA rated); Pin21/Pin23 shorted for QBP closed	22	QE_STATUS	External output switch status (24V/10mA rated); Pin22/Pin24 open for QE closed
23	GND_DRY		24	GND_DRY	
25	NA	Not available	26	NA	Not available
27	UT1_485+	RS485 channel #1, 485+	28	UT2_485+	RS485 channel #2,485+

Pin	Name	Meanings	Pin	Name	Meanings
29	UT1_485-	RS485 channel #1, 485-	30	UT2_485-	RS485 channel #2, 485-
31	GND_MON	Reserved	32	NA	Not available



**Note**

For dry contact port J26, Pin28, Pin30 and Pin27, Pin29 must adopt the metal wire shielded twisted-pair cable, and the end connecting to the UPS must be well connected to the enclosure.

**3.2.5 Programmable Dry Contact Ports J23 ~ J25**

The dry contact ports J23 ~ J25 are shown in Figure 3-10 and described in Table 3-6 and Table 3-7. The dry contact voltages are 24Vdc/250Vac, and the current is 5A. 1, 3, 5 is a group of dry contacts, and 2, 4, 6 are another group of dry contacts. These six-goup of dry contacts are programmable via the Paramset, and you can select any one from the output signals 1~9 in Table 3-6.

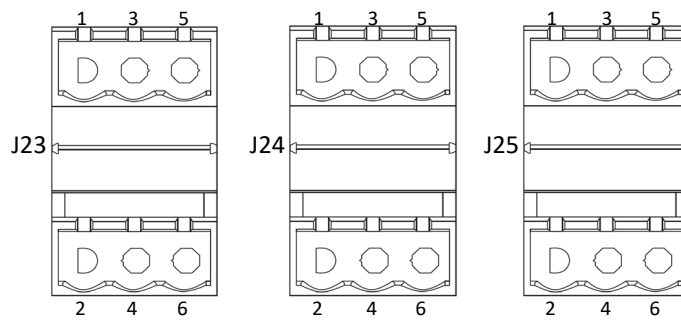

Figure 3-10 Dry contact ports J23 ~ J25

Table 3-6 Selectable dry contact ports

Port	Pin	Default signal
1. Bypass Backfeed	Normally open	Normally open. Closed when bypass SCR is shorted
	Common	Bypass backfeed protection relay common
	Normally closed	Normally closed. Open when bypass SCR is shorted
2. On UPS	Normally open	Normally open. Closed when UPS is in inverter mode
	Common	Inverter mode relay common
	Normally closed	Normally closed. Open when UPS is in inverter mode
3. Input Backfeed	Normally open	Normally open. Closed when rectifier has backfeed
	Common	Rectifier backfeed protection relay common
	Normally closed	Normally closed. Open when rectifier has backfeed
4. Input Abnormal	Normally open	Normally open. Closed when input voltage is abnormal
	Common	Rectifier input voltage protection relay common
	Normally closed	Normally closed. Open when input volage is abnormal
5. On Battery	Normally open	Normally open. Closed when UPS load on battery
	Common	Load on battery protection relay common
	Normally closed	Normally closed. Open when UPS load on battery
6. Low Battery	Normally open	Normally open. Closed when battery is low
	Common	Low battery protection relay common
	Normally closed	Normally closed. Open when battery is low
7. UPS Fault	Normally open	Normally open. Closed when UPS has fault
	Common	UPS fault protection relay common
	Normally closed	Normally closed. Open when UPS has fault
8. On Bypass	Normally open	Normally open. Closed when load on bypass
	Common	Load on bypass protection relay common
	Normally closed	Normally closed. Open when load on bypass
9. Summary alarm	Normally open	Normally open. Closed when UPS has alarm
	Common	UPS alarm protection relay common
	Normally closed	Normally closed. Open when UPS has alarm

Port	Pin	Default signal
10. BCB Trip	Normally open	Normally open. Closed when UPS trip the BCB
	Common	BCB trip relay common
	Normally closed	Normally closed. Open when UPS trip the BCB

Table 3-7 Default setting of output dry contact

Default signal	Pin	Name
1. Bypass backfeed	(J23-1)	Normally open
	(J23-3)	Common
	(J23-5)	Normally closed
2. On UPS	(J23-2)	Normally open
	(J23-4)	Common
	(J23-6)	Normally closed
3. Input Backfeed	(J24-1)	Normally open
	(J24-3)	Common
	(J24-5)	Normally closed
4. Input Abnormal	(J24-2)	Normally open
	(J24-4)	Common
	(J24-6)	Normally closed
5. On battery	(J25-1)	Normally open
	(J25-3)	Common
	(J25-5)	Normally closed
6. Low Battery	(J25-2)	Normally open
	(J25-4)	Common
	(J25-6)	Normally closed

### 3.2.6 REPO Port

The UPS has an EPO function that operates by an EPO button on the operator control and display panel of the UPS or by a remote contact provided by the user. The EPO button has a protective cover.

J2 is the REPO port. The port is shown in Figure 3-11 and described in Table 3-8.

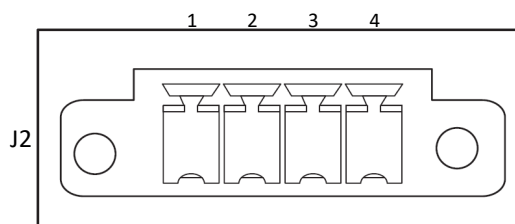



Figure 3-11 REPO port J2

Table 3-8 Description of REPO port J2

Pin	Name	Meanings	Pin	Name	Meanings
1	EPO-NC	EPO activated when opened to Pin 2	3	+ 12V	EPO activated when shorted to Pin 4
2	+ 12V	EPO activated when opened to Pin 1	4	EPO-NO	EPO activated when shorted to Pin 3

EPO is triggered when pins 3 and 4 of J3 are shorted or pins 2 and 1 of J2 are opened.

If an external EPO facility is required, pins 1 and 2 or 3 and 4 of J2 are reserved for this function. The external EPO facility is also connected to the normally open or normally closed remote EPO switch between these two terminals using shielded cable. If this function is not required, pins 3 and 4 of J2 must be opened and pins 1 and 2 of J3 must be shorted.

 <b>Note</b>
The UPS EPO action shuts down the rectifier, inverter and static bypass, but it does not internally disconnect the mains input power. To disconnect all power to the UPS, open the external power switch, bypass input switch, output switch and BCB after EPO is activated.

### 3.2.7 RS232 Communication Port

See Figure 3-12 for the diagram of RS232 communication port.

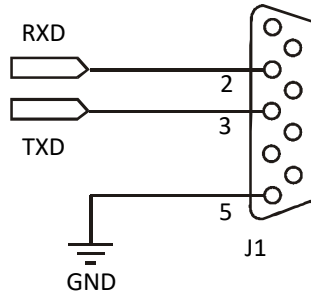

Figure 3-12 RS232 communication port

This port monitors and sets parameters through connecting with computer.

The RS232 communication port provides serial data and is intended for use by authorized commissioning and service personnel in UPS commissioning and service.

### 3.2.8 Parallel And LBS Communication Ports

See Figure 3-6 for their positions.

### 3.2.9 Intellislot Port

The Intellislot ports are used for installing optional cards on the site, including IS-UNITY-DP card, IS-Relay card, and SIC card. Table 3-9 provides models and installation positions of the optional cards. For the detailed installation of the optional cards, refer to the corresponding contents in *Chapter 8 Options*.

Table 3-9 Models and installation positions of optional cards

Optional card	Model	Installation position
IS-UNITY-DP card	IS-UNITY-DP	Intellislot ports 1 ~ 3 (port 1 or 2 recommended)
SIC card	UF-SNMP810	Intellislot ports 1 ~ 3 (port 1 or 2 recommended)
IS-Relay card	IS-RELAY	Intellislot port 1

 <b>Note</b>
1. The Intellislot port 2 shares communication resource with RS485 port. To avoid conflict, when using RS485 port in service and commissioning, it is not recommended to use the Intellislot port 2. 2. The Intellislot port 3 shares communication resource with RS232 port. To avoid conflict, when using RS232 port in service and commissioning, it is not recommended to use the Intellislot port 3.

### 3.2.10 Signal Cable Connection Steps

 <b>Note</b>
Respectively route the power cables and signal cables. The shielding coat of signal cable must be reliably earthed.

Two connection modes are available: top cable access, bottom cable access. See Figure 3-13 to Figure 3-16.

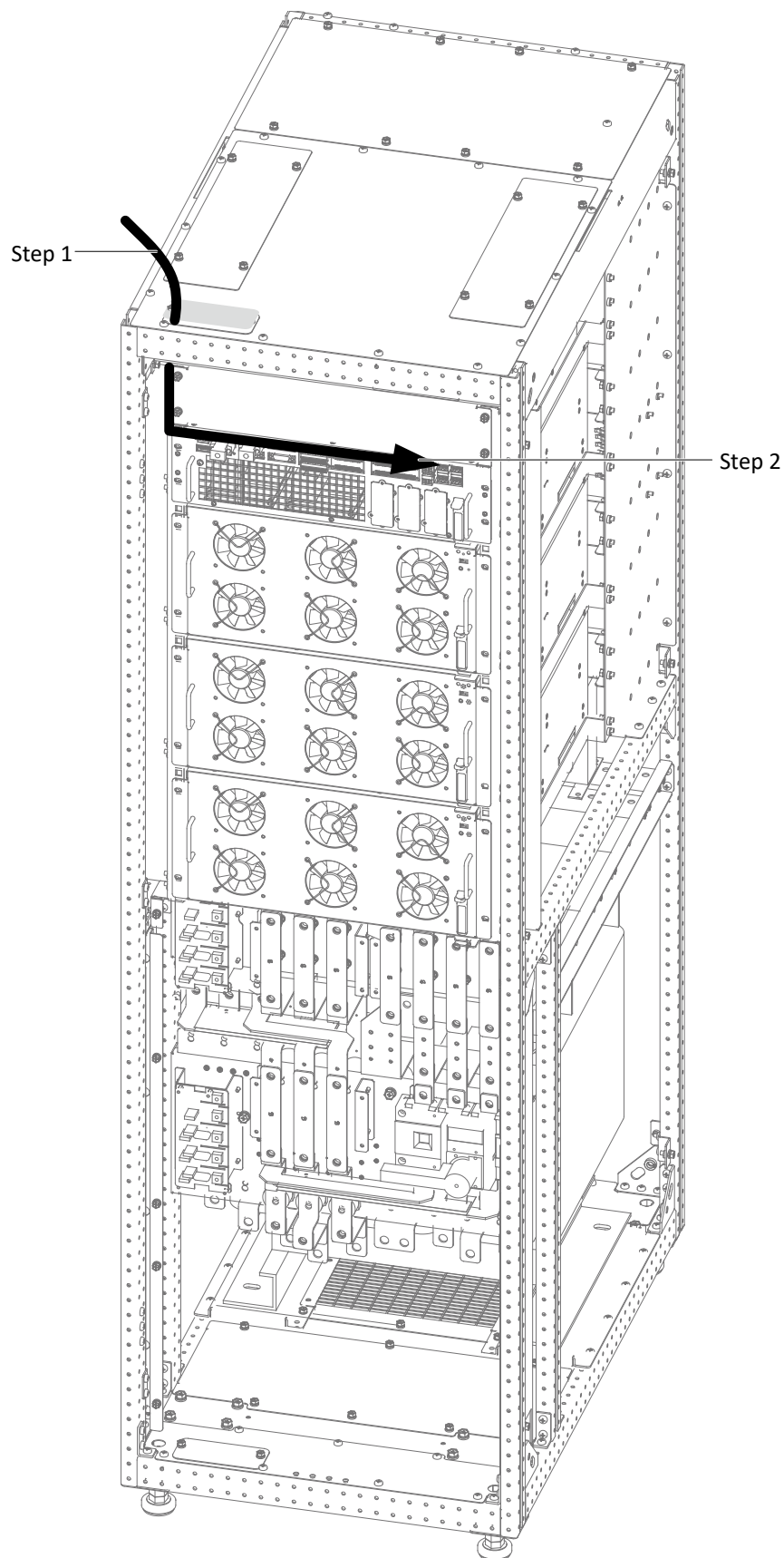

**Note:**

**Step 1:** Remove this top cover, and lead cables into the cabinet.

**Step 2:** Connect cables to corresponding terminals.

Figure 3-13 Signal cables wiring route of 80kVA ~ 120kVA (top cable access)

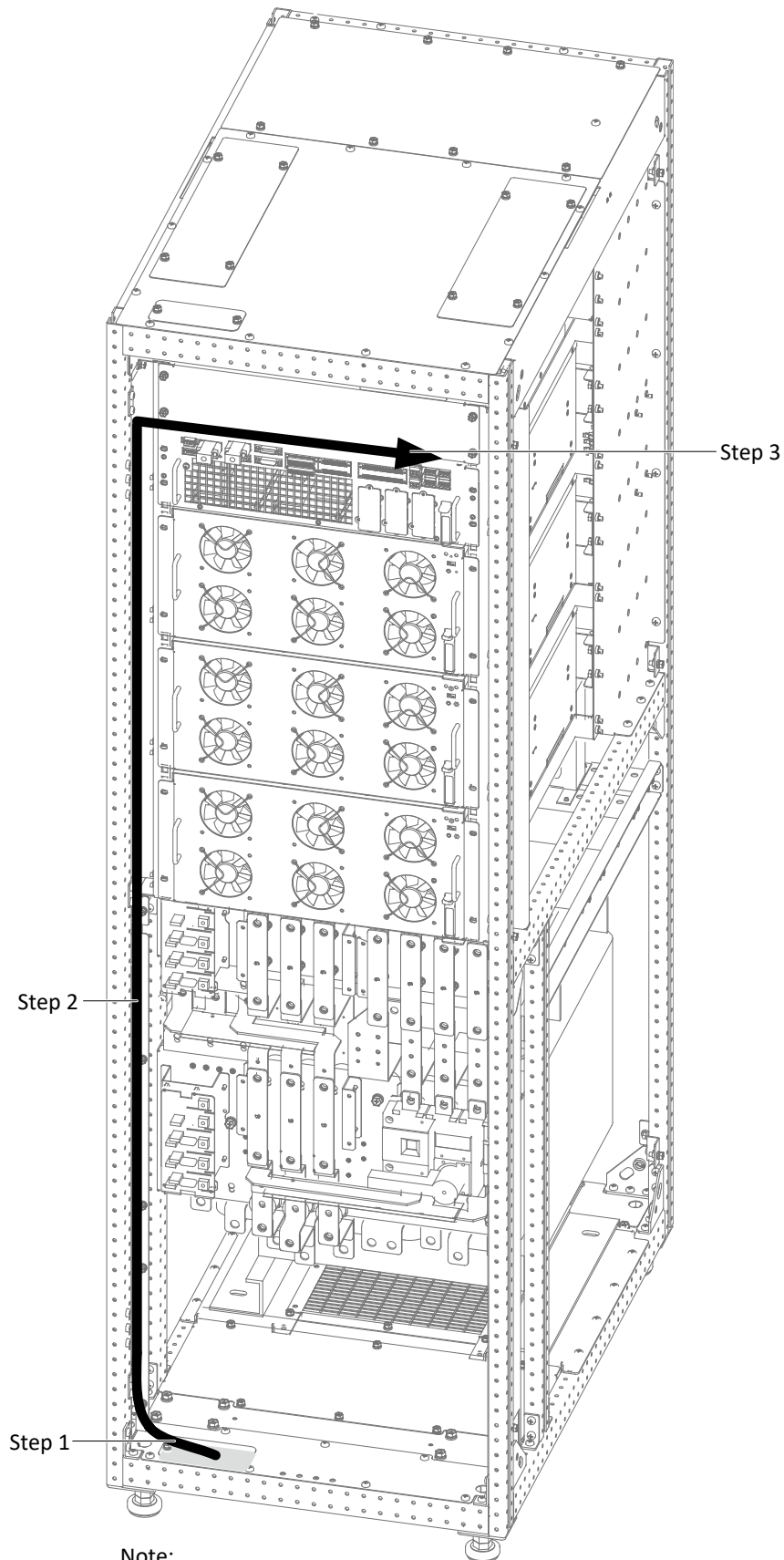

**Note:**

**Step 1:** Remove this bottom plate, and lead cables into the cabinet.

**Step 2:** Route cables along the cabinet inside, and use cable ties to bind them.

**Step 3:** Connect cables to corresponding terminals.

Figure 3-14 Signal cables wiring route of 80kVA ~ 120kVA (bottom cable access)

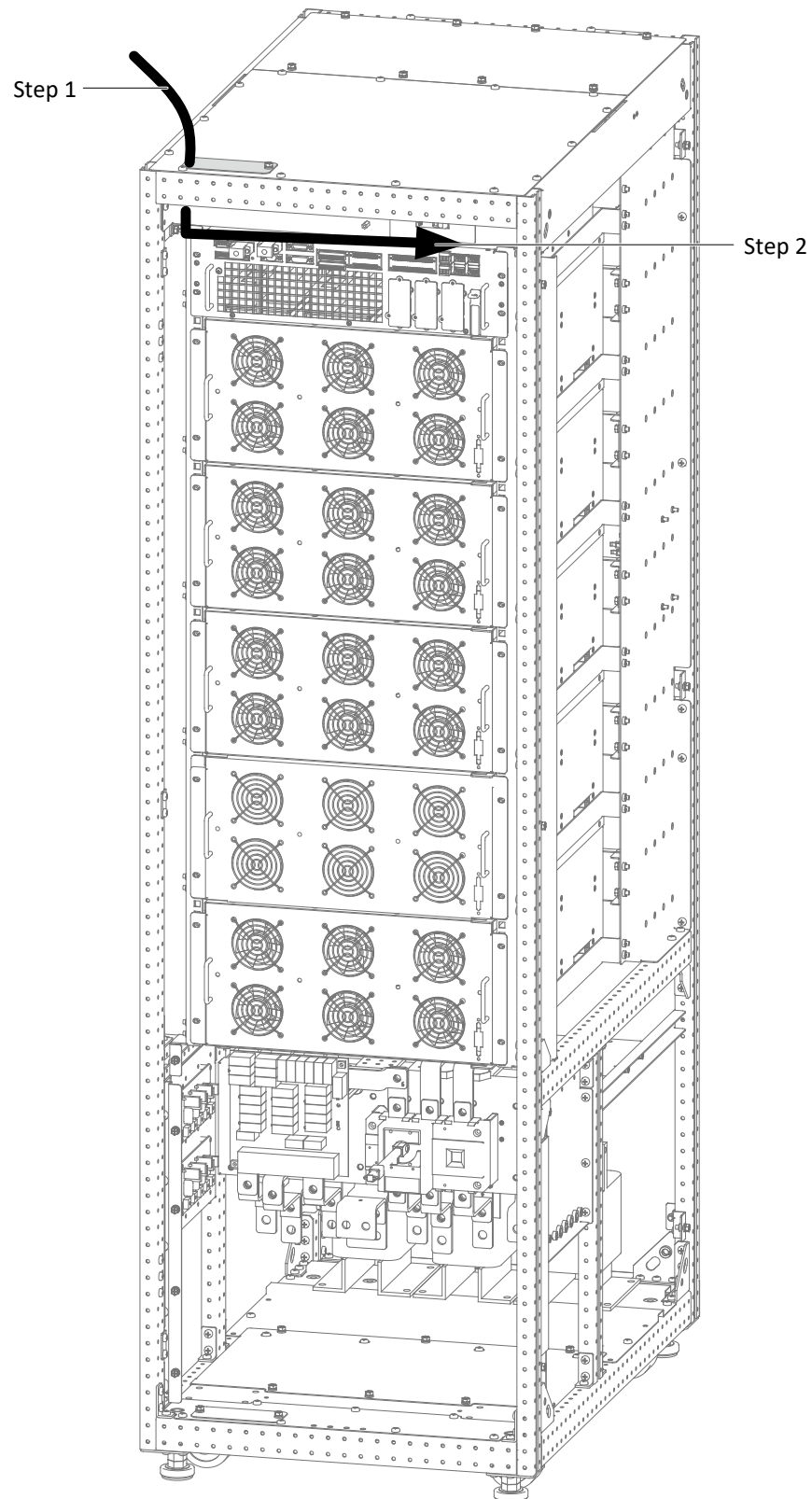

**Note:**

**Step 1:** Remove this top cover, and lead cables into the cabinet.

**Step 2:** Connect cables to corresponding terminals.

Figure 3-15 Signal cables wiring route of 160kVA ~ 200kVA (top cable access)

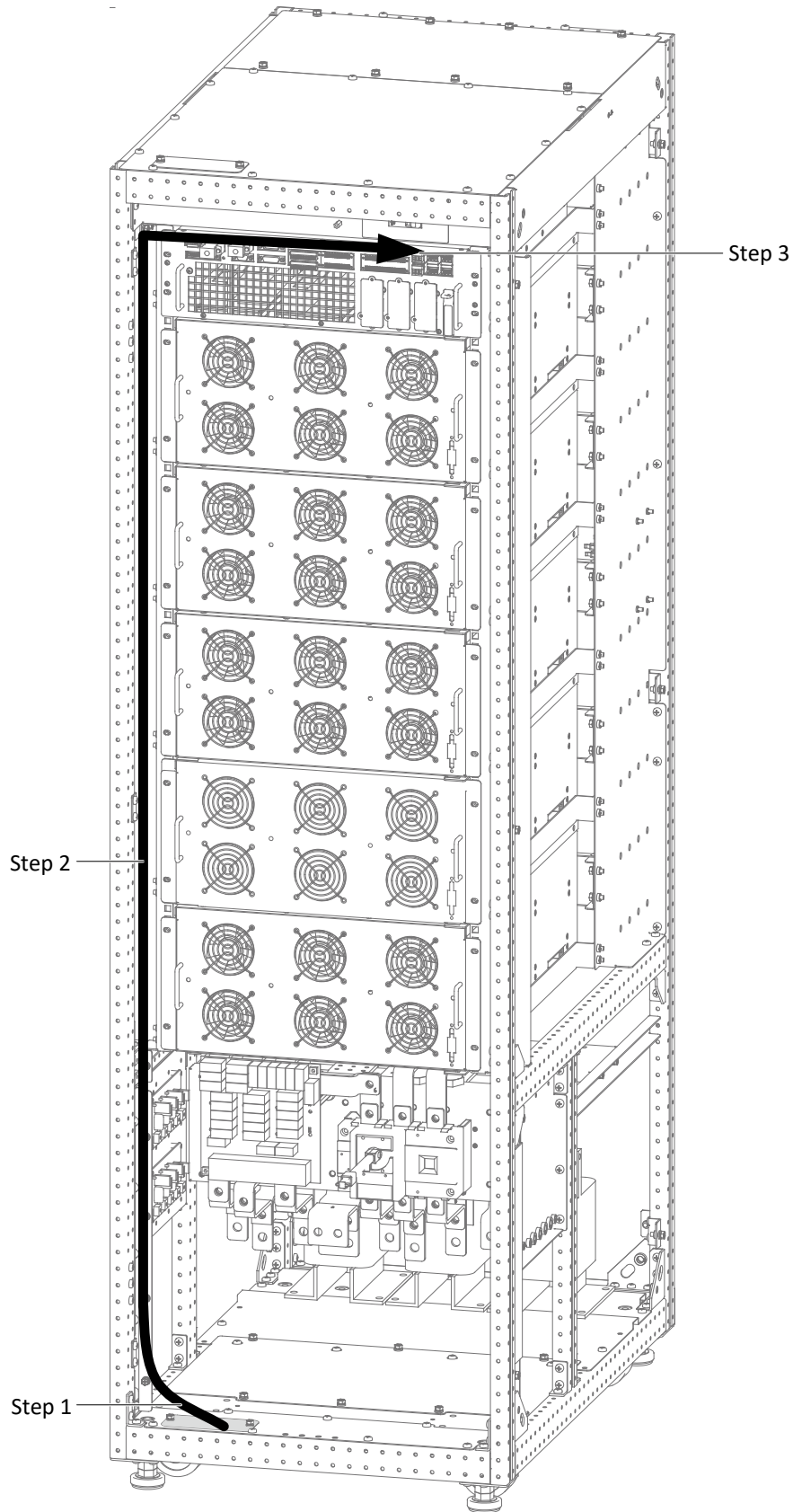

**Note:**

**Step 1:** Remove this bottom plate, and lead cables into the cabinet.

**Step 2:** Route cables along the cabinet inside, and use cable ties to bind them.

**Step 3:** Connect cables to corresponding terminals.

Figure 3-16 Signal cables wiring route of 160kVA ~ 200kVA (bottom cable access)



## Chapter 4 Operator Control And Display Panel

### 4.1 Introduction

The Liebert EXM Touchscreen Control Panel's integrated interface simplifies monitoring and managing single or multiple Liebert UPS modules. The control collects a profusion of information about the health of the modules and presents it in a standardized format. This simple, dynamic display speeds operator response to changing power input and demand. Many of the settings will depend on the UPS type and features. Many other settings will be made during the UPS setup by Vertiv Tech service personnel. The Liebert EXM Touchscreen Control Panel's interface will display data either graphically or in text. The Status Scroll Bar at the top of the touchscreen display summarizes system conditions. The bar changes color to indicate status and includes an icon matched to the status. The Status Gauge displays such details as power demand from the connected load, input power quality, output and bypass on each phase and battery capacity. The Liebert EXM Touchscreen Control Panel's mimic display shows the comprehensive system information that the operator needs: Is input power connected? Are there any alarms? Which breakers are open and which are closed? Is the UPS on battery? How much run time is available? Checking a particular component is as simple as touching it on the mimic display—Detailed data appears, allowing the operator to respond. Visual and audible alarms alert personnel to faults and alarms requiring immediate attention. Passcodes for each level of access—Operator, Administrator and Service—secure the UPS against unauthorized changes. Personnel without a passcode can view UPS status, but cannot change any functions or the appearance of the interface.

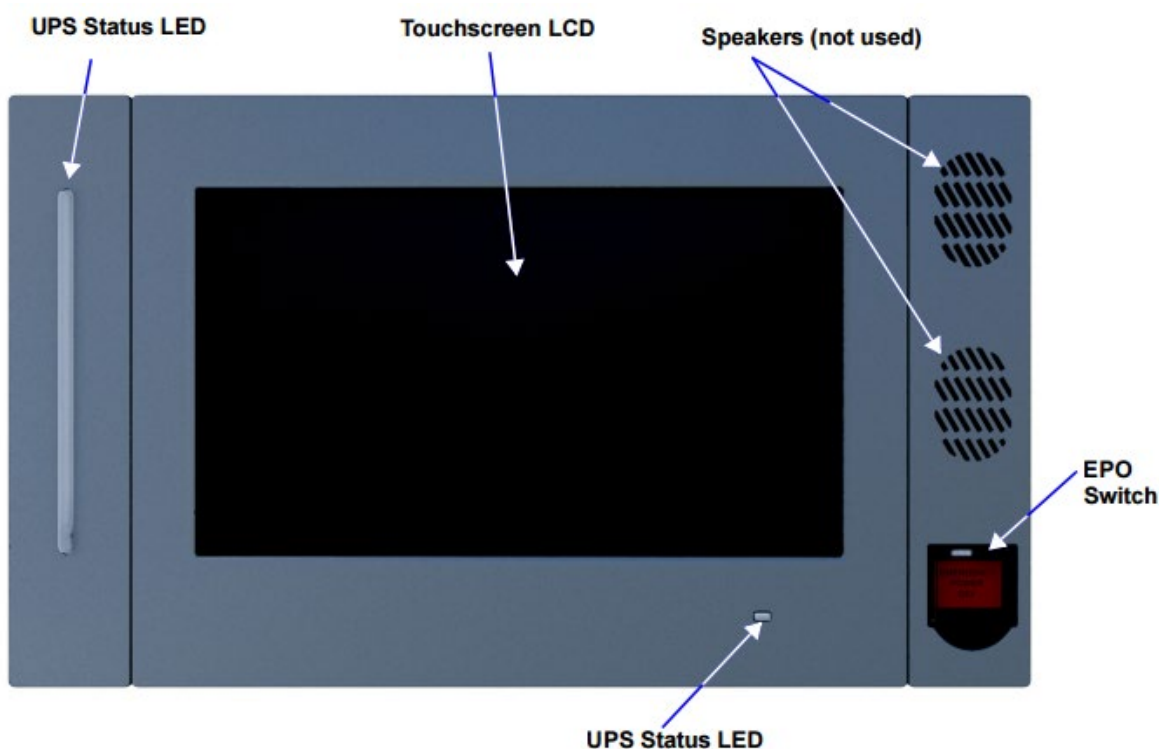

Figure 4-1 Liebert EXM Touchscreen Control Panel components

## 4.2 Navigating Through The Liebert EXM Touchscreen Control Panel

The Liebert EXM Touchscreen Control Panel is active whenever the UPS has input power. The touchscreen TOUCHSCREEN on the front of the UPS permits:

- Logging in to the system--4.3.1 *Log In to the Liebert EXM Touchscreen Control Panel*
- Customizing the user interface--4.3.2 *Customizing the Display*
- Checking the status of the UPS and its external batteries, including all measured parameters, events and alarms--4.4 *Viewing UPS Status* and 4.5 *Viewing UPS Component Status*
- Silencing alarms--Silence an Alarm
- Turning the UPS On--Inverter On
- Turning the UPS Off--Inverter Off
- Resetting faults--Reset Fault
- Enabling Energy Saving Mode--Energy Saving Mode Activation

The Liebert EXM Touchscreen Control Panel's display default view is two panes: One-line animated mimic and UNIT STATUS. The appearance can be changed to multiple panes that show other data. Customizing the appearance is detailed in 4.3.2 *Customizing the Display*.

### 4.2.1 Access Level Log-In

The Liebert EXM Touchscreen Control Panel provides security by limiting the authority to change how the UPS operates. Each of the four access levels offers different authority:

- Observer--Viewing permission only; can choose graphic or text display; no PIN required
- Operator--Permission to start the UPS, shut the system down, reset faults and enable or disable Eco Mode operation; PIN required
- Administrator--All functions of Operator plus permission to change PINs for Operator and Administrator level; PIN required
- Service--All functions of Administrator plus permission to alter system configuration, choose serial communication protocol, enable equalize battery charging and change Service PIN; PIN required.

Vertiv Tech Liebert Services sets PINs when setting up the UPS. These default PINs may be changed by those with Administrator or Service access (see above).

Default PINs are:

- Operator: 1234
- Administrator: 2345



#### Note

Risk of unauthorized changes to operational settings. Can cause equipment damage. The default PIN numbers should be changed immediately to prevent unauthorized personnel from changing UPS operation or even shutting down the UPS. The PINs for Operator and Administrator may be changed by logging in with either Administrator or Service level access.

## 4.2.2 Liebert EXM Touchscreen Control Panel Components

The main areas of the Liebert EXM Touchscreen Control Panel are shown in Figure 4-2. The display arrangement and the information displayed can be changed. At log-in for all access levels, the Liebert EXM Touchscreen Control Panel opens to the STATUS screen in graphic display. The STATUS screen will show the animated mimic and system status readings at each log-in level. The appearance will differ only in the function menus displayed (see Figure 4-3).

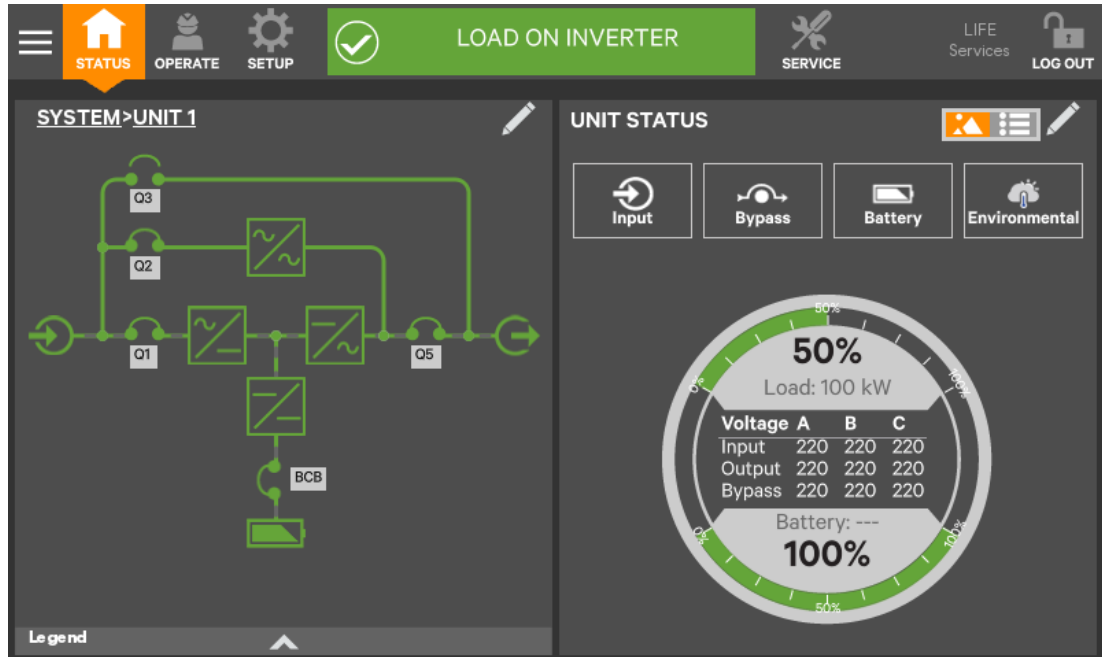

Figure 4-2 Interface overview—STATUS screen; graphic display

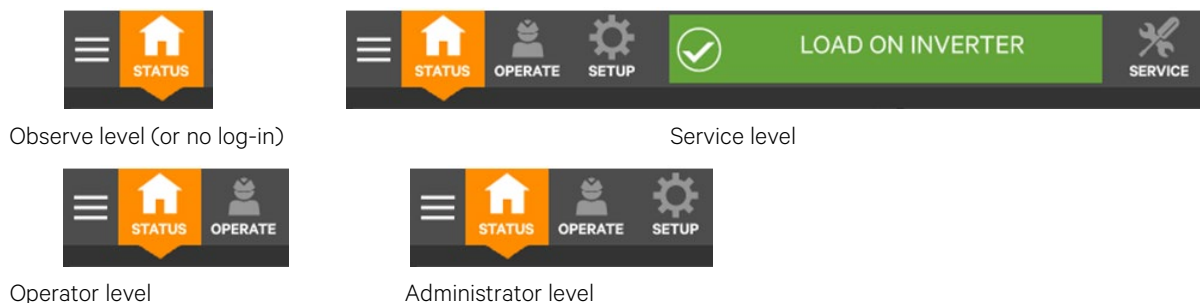

Figure 4-3 Control display by access level

Information and control are different under each Function Menu. The Function Menus displayed are specific to the access level.

- STATUS: Condition of the UPS components and data affecting operation and performance; visible to all access levels.
- OPERATE: UPS operation controls, such as inverter on, inverter off, energy saving status; visible to Operator, Administrator and Service
- SETUP: Manage permissions through PINs; visible to Administrator and Service
- SERVICE: Input wiring and breaker configuration, protocol used and battery charging method; visible to Service

### Context Menu

The Context Menu, available by touching the icon at the top left corner of the interface, displays information about the UPS and permits changing various settings. The functions possible through the Context Menu are determined by the user's access level and on the Function Menu that is active (see Figure 4-4).

The menus under Display Options on STATUS, for example, differ for each access level. Some information available through the Context Menu, such as alarms and run hours, are available through other areas of the Liebert EXM Touchscreen Control Panel.

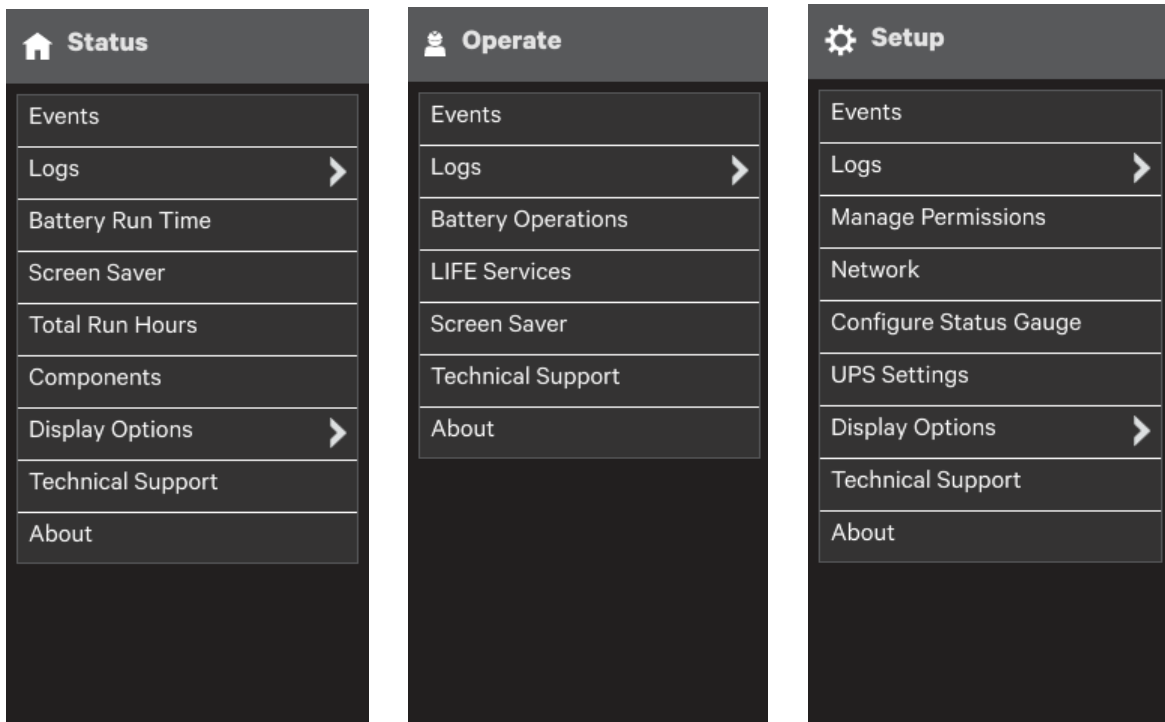

Figure 4-4 Context Menus

Touching a menu item will reveal data or expand the menu to show additional options.

- Alarms: Date and time of occurrence, type of alarm, Event ID, component affected and description; see also *Using the Edit Icon to Customize Layout*; same options for all access levels except Observers cannot acknowledge alarms.
- Logs: UPS Event Log with date and time of occurrence, type of event, Event ID, status, component affected and description; see also *Using the Edit Icon to Customize Layout*; same options for all access levels
- Battery Run Time: Battery Cycle Monitor with duration and count; same options for all access levels
- Screen Saver: Display Sleep Mode notification (immediate entry into screen saver); screen goes dark and user is logged off; interface reactivated by touching the screen; same options for all access levels
- Total Run Hours: Component and hours it has operated; touching a component displays details in the right panel; see also *Using the Edit Icon to Customize Layout*
- Components: Component status, name and details
- Display Options (Changes affect view for all access levels)
- Customize Layout: Change panel content and layout (see 4.3.2 *Customizing the Display*); not available to Observer
- Display Properties: Language, backlight timer, alarm timeout, auto-log-out timer, display brightness, status indicator brightness and touchscreen calibration (see 4.3.2 *Customizing the Display*); language and display brightness only are available to Observer
- Date & Time: Drop-down lists for time zone, date, local time and UTC time (Coordinated Universal Time) (see 4.3.2 *Customizing the Display*); not available to Observer
- Formats: Drop-down lists for date and time format and measurement system (metric or imperial) (see 4.3.2 *Customizing the Display*)
- Technical Support: Manufacturer's support: Web site, e-mail address and telephone numbers
- About: Information about the UPS and its software and firmware; UPS model, rating, configured capacity, model number and serial number

### Mimic Display Components

The animated mimic display shows each configured major component of the UPS system, for both single-module and multi-module systems. The mimic display is the same for all access levels. The power path is shown by animated lines; moving dashes show the active power path. Breakers are shown as open or closed (see Figure 4-5), but are not interactive.

Components in the mimic display signify their operational status by their color, green, amber or red. Tables 1 through 3 describe the various states of the indicators. Touching a component brings up details about its status

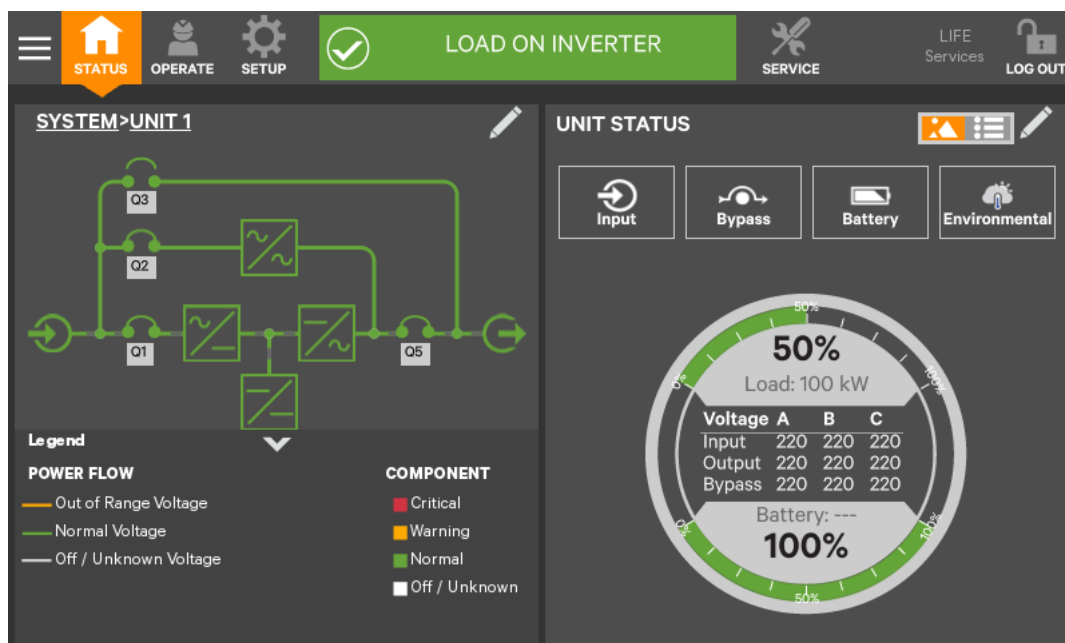

Figure 4-5 Mimic display, normal operation

### UNIT STATUS Pane Components

The UNIT STATUS pane is identical for all PIN access levels (see Figure 4-6) Observers will not have the pencil edit icon. In the default graphic view, the UNIT STATUS pane shows:

- Status Gauge--Connected load shown in kW and as a percentage of capacity; input, output and bypass voltage for each phase (default data may be changed; see 4.4.1 *Viewing UPS Data with the Status Gauge*).
- Input Detail Icon
- Battery Detail Icon
- Bypass Detail Icon
- Load Detail Icon
- Environmental Detail Icon

Touching any of the detail icons reveals additional data about that selection in the opposite pane. The data pane may be closed by touching the Close radio button or by touching the same or another detail icon. The read-only information is available to all access levels (see Figure 4-7).



#### Note

If the Status Gauge is showing, no more than four detail icons will be visible at a time. Removing the Status Gauge permits showing all five detail icons. The view may be customized to show fewer than four.

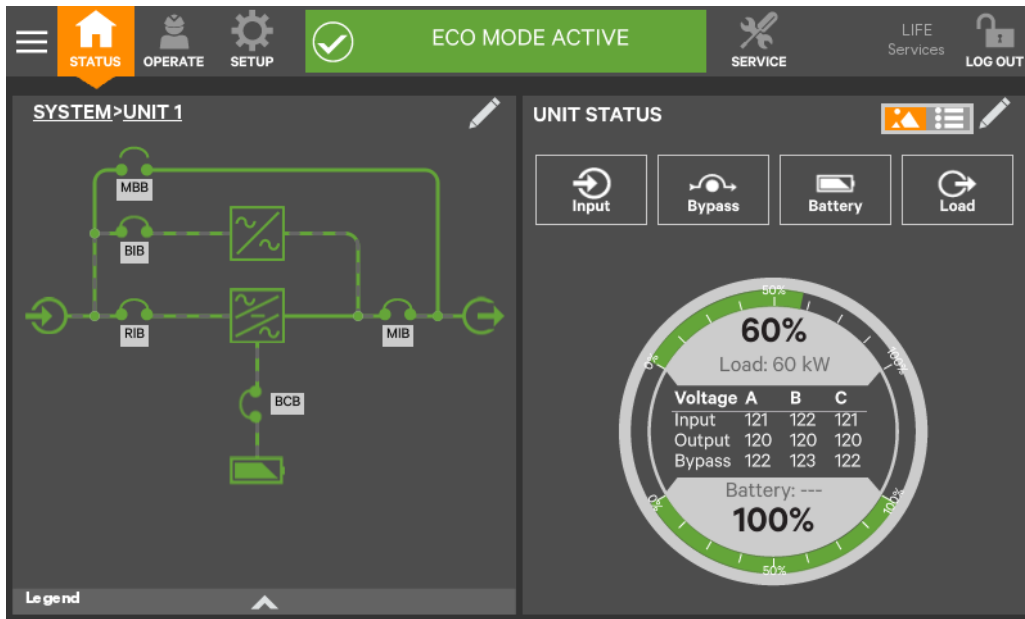

Figure 4-6 UNIT STATUS pane components; graphic display



Figure 4-7 UNIT STATUS pane—Input details; graphic display

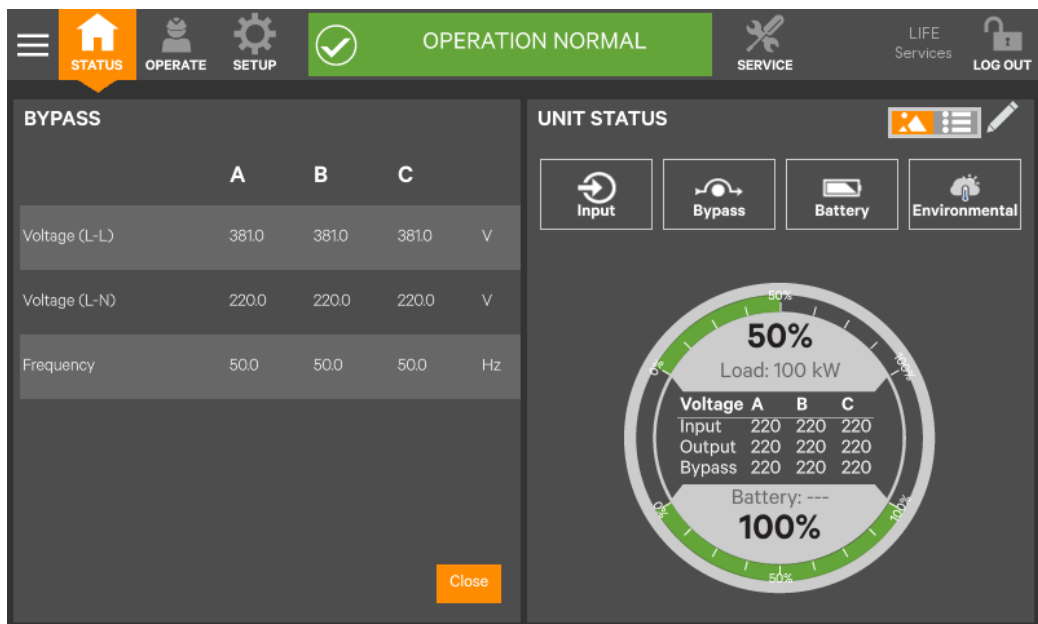

Figure 4-8 UNIT STATUS pane—Bypass details; graphic display

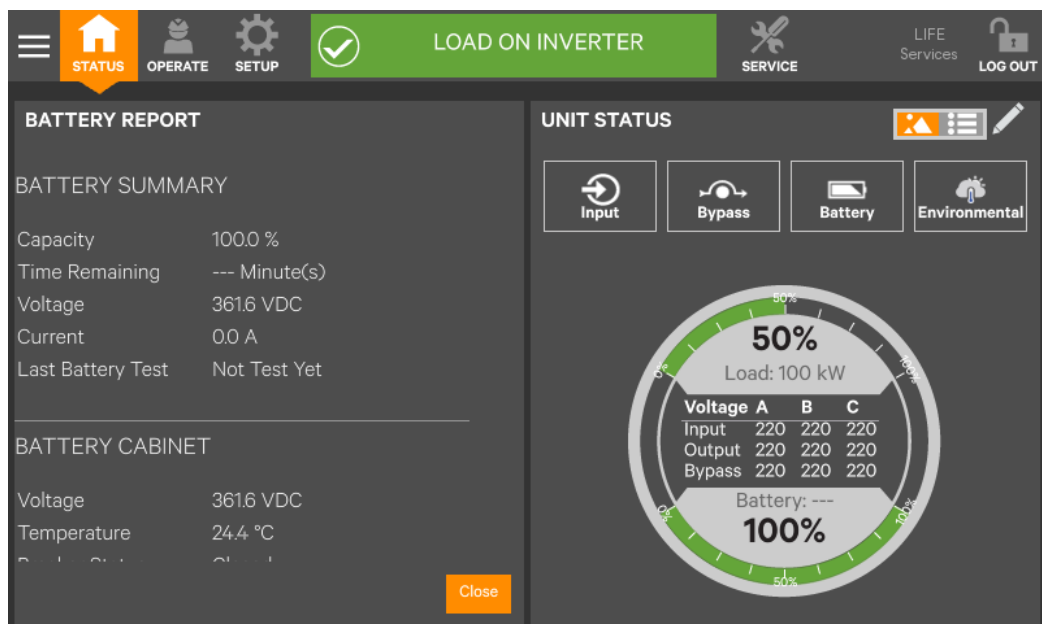

Figure 4-9 UNIT STATUS pane—Battery and cabinet details; graphic display

## 4.3 Operation

### 4.3.1 Log In To The Liebert EXM Touchscreen Control Panel

The Liebert EXM Touchscreen Control Panel is On whenever the UPS has control power. It may be inactive and appear dark, depending on its settings. If it is inactive, touch the TOUCHSCREEN to wake it up.

To log in to the Liebert EXM Touchscreen Control Panel:



1. Touch the LOG IN icon  at the top right of the screen. The lock and background will change color and open the PIN REQUIRED screen, which has a keypad.
2. Enter a PIN at the screen below.
3. Touch Enter

**Note**

Entering an incorrect PIN will generate a screen saying the number is invalid.

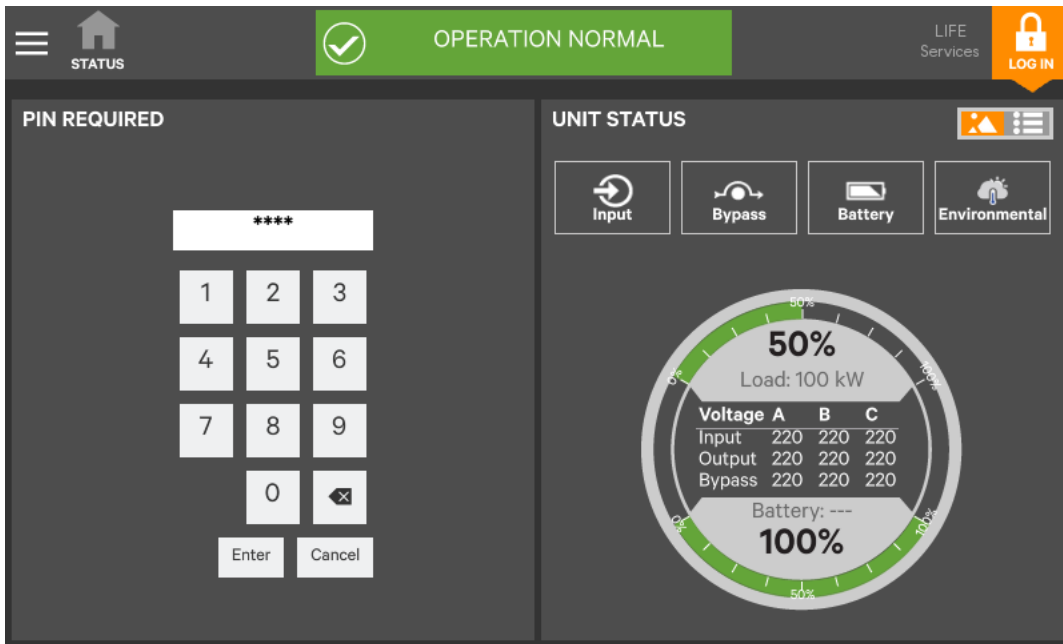

Figure 4-10 Log in screen

### 4.3.2 Customizing The Display

The Liebert EXM Touchscreen Control Panel's default appearance will be adequate for most installations, but the Status panels can be altered to show additional or different data. Layouts may be chosen by any user with a PIN: Operator, Administrator or Service; the layout chosen will be applied to all users. Layouts may be created or altered only with Administrator or Service Access.

**Note**

The original configuration, Default View 1, cannot be deleted. Editing through the menus will create a new view with the new settings. The Default View 1 can be altered with the pencil edit icon in the display (see *Using the Edit Icon to Customize Layout*).

To customize the display's appearance:

1. Log in to the Liebert EXM Touchscreen Control Panel as Administrator or Service detailed in 4.3.1 *Log In to the Liebert EXM Touchscreen Control Panel*.
2. From the STATUS view, touch the Context Menu icon in the top left corner (shown at right).



3. Select Display Options -> Customize Layout. (The right pane details how to edit or create a view; see Figure 4-11.) Edit a View
4. Touch a view to highlight it or touch Edit to change that view. Create a View
5. Touch the New button to create a view.





Figure 4-11 Customize the display

6. Either accept the generated name (New View) or touch the view's name to rename it using the on-screen keyboard (maximum length is 14 characters). Touch the Enter key  on the on-screen keyboard after entering the new name.
7. From the drop-down list under the Layout heading, select the number of panes in the new or edited view (the maximum is four).
8. Choose the data to be displayed in each pane by touching a choice in the PANEL OPTIONS and then touching the appropriate panel. Repeat for each pane.
9. Touch the Save button to keep the changes or touch the Cancel button to exit the screen without saving.

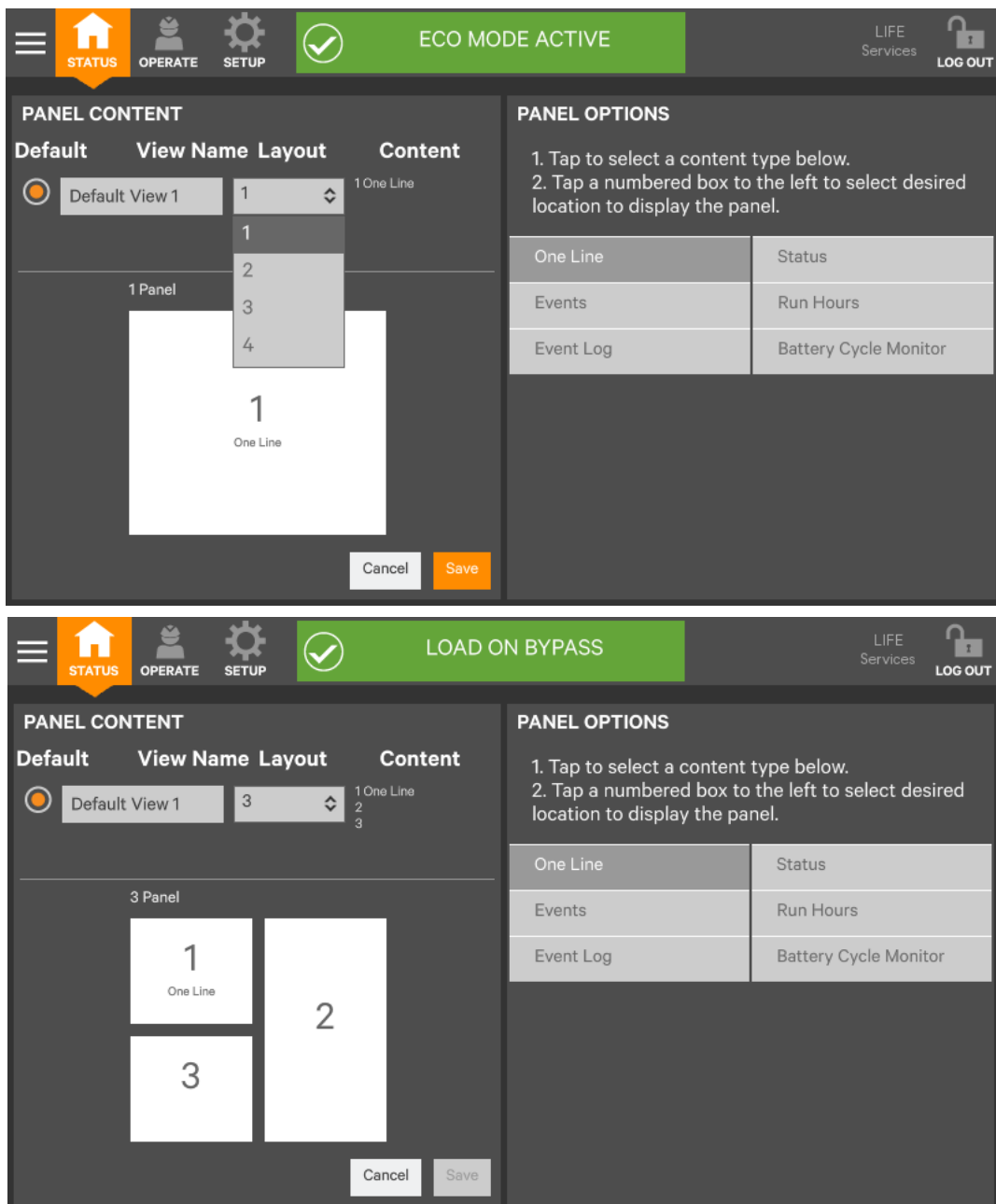

Figure 4-12 Set number of panes and choose data

10. Touch the Save button.
11. When the window returns to two screens—PANEL CONTENT and PANEL OPTIONS—touch the radio button beside the new view to activate it (this puts a dot inside the circle).
12. Touch Save.
13. Touch the STATUS menu icon to see the new appearance.

To choose an existing layout, navigate to the PANEL CONTENT screen and touch the radio button beside the layout, then touch the STATUS menu icon.

**Remove a Layout**

To delete a layout:

Log in with Administrator or Service access.

**Using the Edit Icon to Customize Layout**

The Liebert EXM Touchscreen Control Panel layout can also be changed with the Edit icons on the screen for a user logged-in as Operator, Administrator or Service. The Edit icon can be used to add or remove panels, resize panels, rearrange panels and change monitored parameters.

To use the Edit icon:

1. Touch the Edit icon  on the panel to be edited and hold it until a Change content button appears on the panel (about 1 second).

Change Panel

2. Touch an icon to choose the data to be displayed in the panel (see Figure 4-13); choices are:

One-Line Run Hours

Status Event Log

Alarms Battery Cycle Monitor Summary

Change UNIT STATUS Panel Content

3. To change the UNIT STATUS panel's data:

- a. Touch the Edit icon on the UNIT STATUS panel and hold it until the Change Content button and X's appear beside the parameters.

- b. Touch the X beside the parameter to be removed from the panel. The Add Parameter icon (+) will appear in the panel if another parameter can be added. The number of parameters possible is based on whether the Status Gauge is showing.

- c. Touching the Add Parameter icon  brings up a window to add parameters not already shown on the UNIT STATUS panel.

- d. Touch a parameter's icon to add it to the UNIT STATUS panel. Resize or Remove a Panel

4. Touch and hold the Edit icon again while the Change content button is displayed.

5. Release the icon. Resize handles will appear around the panel and a large X will appear at the top right corner.

6. Pull on a handle to resize the panel, or

7. Touch the large X to delete the panel.

Rearrange Panels

8. With the resize/remove handles visible, touch the circle in the center of the panel and drag the panel to its new position.

Exit Edit Mode

9. Edit Mode will deactivate after some changes. If all changes have been made and Edit Mode is active, touch the panel's header area.

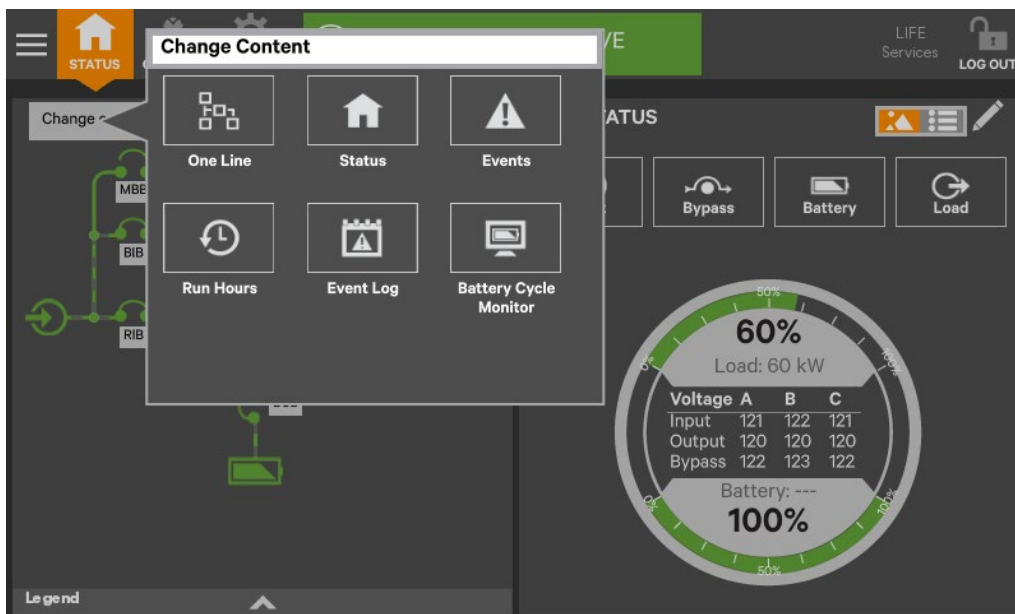

Figure 4-13 Change panel content or resize/remove a panel

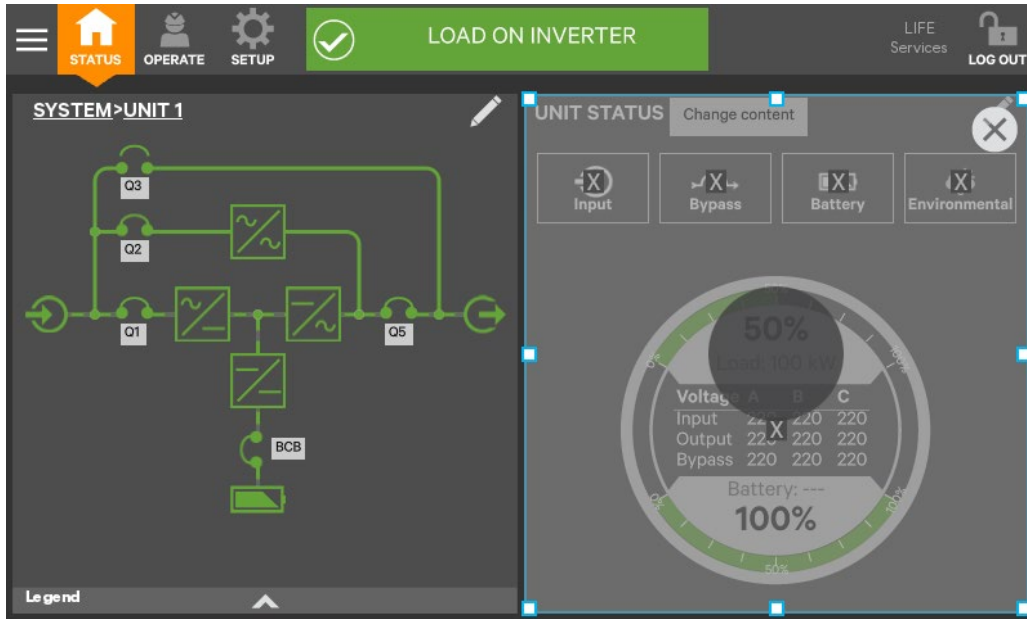

Figure 4-14 Resize or remove a panel

**Edit UNIT STATUS Panel with the Edit Icon**

The UNIT STATUS panel may be changed to add or remove data. The panel has four default parameters. Any or all can be deleted or replaced with the Editing icon.

Possible parameters for the UNIT STATUS panel are:

- Input
- Bypass
- Battery
- Environmental
- Load



**Note**

Changes made to the UNIT STATUS panel will be applied to all views using the panel.

To edit the UNIT STATUS panel:

1. Activate the editing mode by touching and holding the Edit icon on the UNIT STATUS panel.

2. Touch the large X by a parameter icon to delete it or touch the + icon  at the bottom right of the panel to add a parameter icon.

3. Touch the header area to deactivate the edit mode.

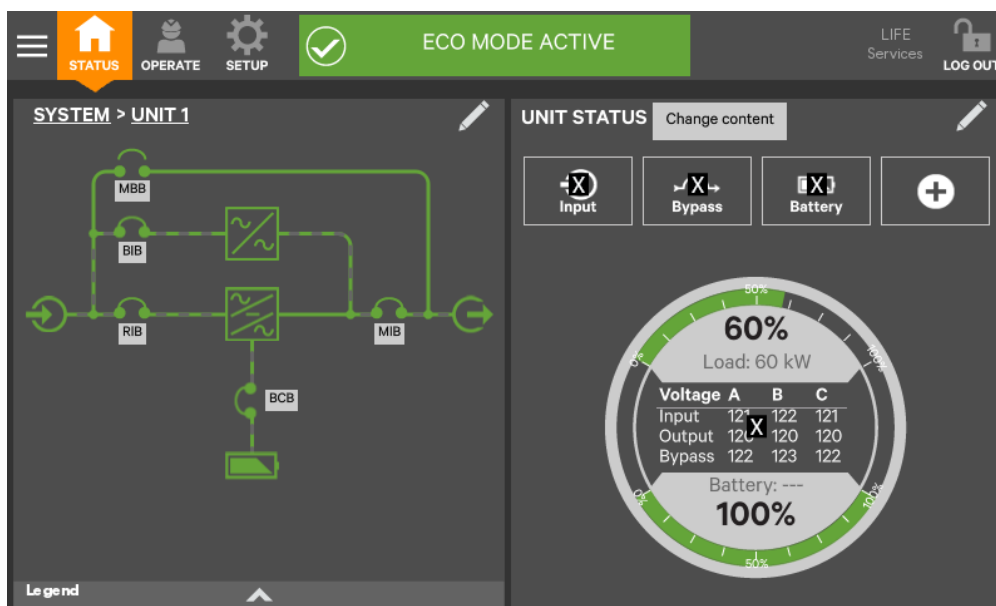

Figure 4-15 Edit UNIT STATUS panel

### 4.3.3 Operator Controls

The Operator login confers control of UPS functions:

- Silence (Alarm)
- Inverter On
- Inverter Off
- Reset Fault
- Energy Saving Mode Activation
- Battery Operations

Each command is available under the OPERATE menu. The OPERATE menu may be used by logging in with Operator, Administrator and Service access.



#### Note

Risk of improper operation. Can cause load drop resulting in equipment damage. The Inverter On, Inverter Off, Reset Fault and Energy Saving Mode Activation commands will be available whenever the UPS is operating. Before executing any command, verify that the UPS status is suitable for the command to be performed.

#### Operate Menu Commands

All Operator commands are available from the OPERATE menu. The menu is available whenever the UPS has input power. The UPS need not be supplying power to the load for the menu to be available. The animated mimic is not linked to data in this view—touching a component will not cause it to display data.

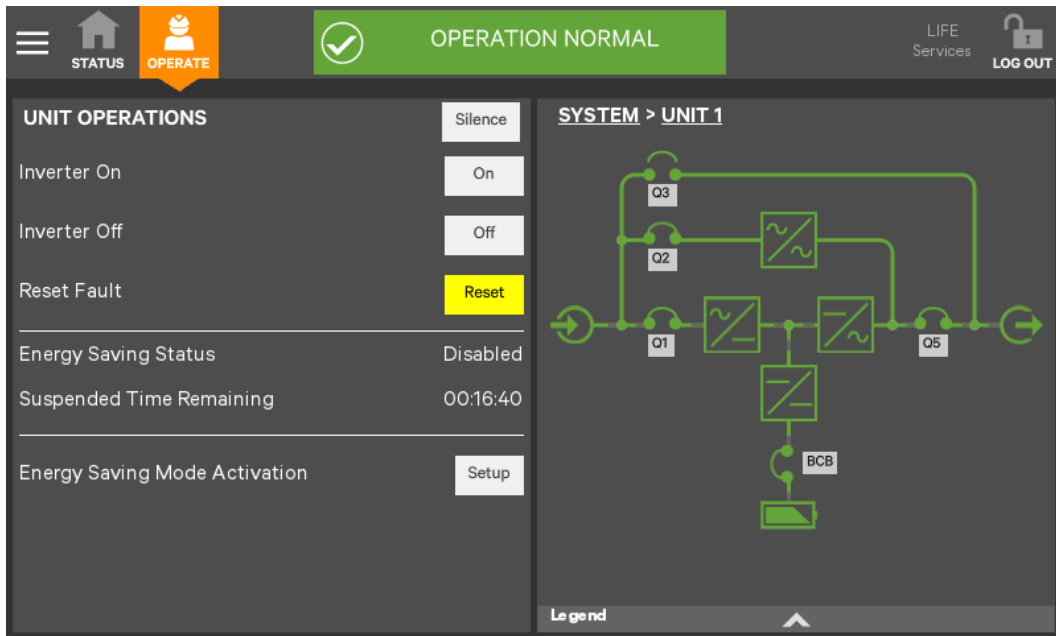

Figure 4-16 OPERATE menu—Operator login

**Silence an Alarm**

To silence an alarm, touch the Silence radio button at the top of the panel. The time the alarm will remain silenced varies, depending on the UPS type, type of alarm and configuration.

**Inverter On**

The Inverter On menu item is available whenever the UPS has input power and the inverter is Off. Before executing the command, verify that the UPS is prepared for the inverter to start. Operator access shown; commands are the same for all access levels. Operation 15 Liebert® EXM™ Touchscreen Control Panel The Liebert EXM Touchscreen Control Panel will display a message asking for confirmation and noting that it may take a moment to start (see Figure 4-17). The control will display a progress window while the inverter starts.

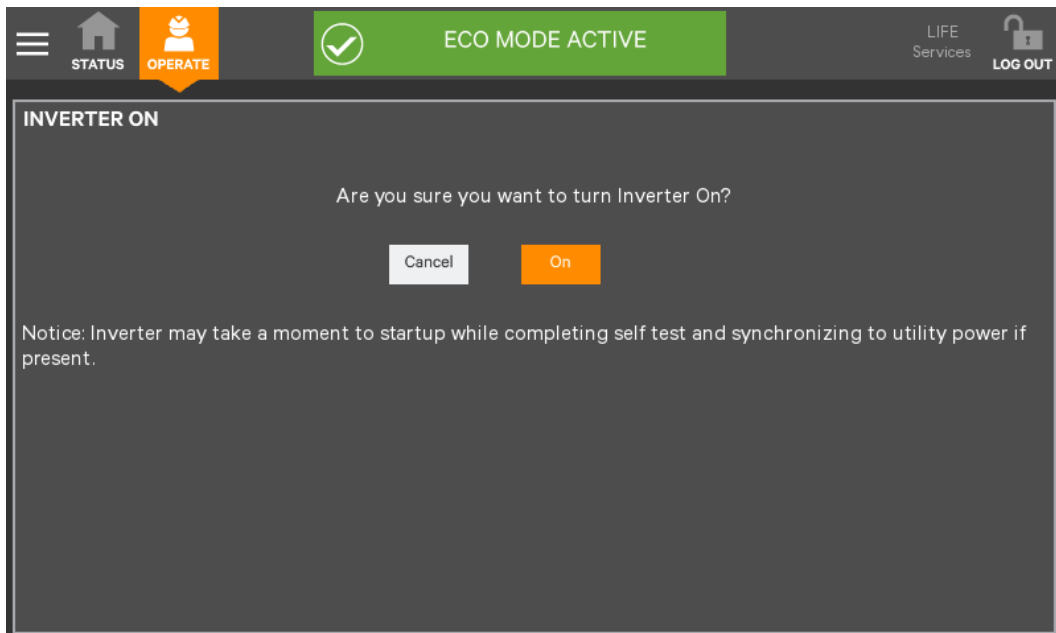



Figure 4-17 Inverter On command

**Inverter Off**

The Inverter Off menu item is available whenever the UPS has input power and the inverter is Off. Before executing the command, verify that the UPS and connected load are prepared for the inverter to be shut down.

 **Note**

Risk of improper operation. Can cause load drop resulting in equipment damage. The Inverter Off will shut off power to the connected load unless bypass power is available. Before executing this command, verify that the connected load is either shut off or that input power to the load will be supplied by another source, such as bypass.

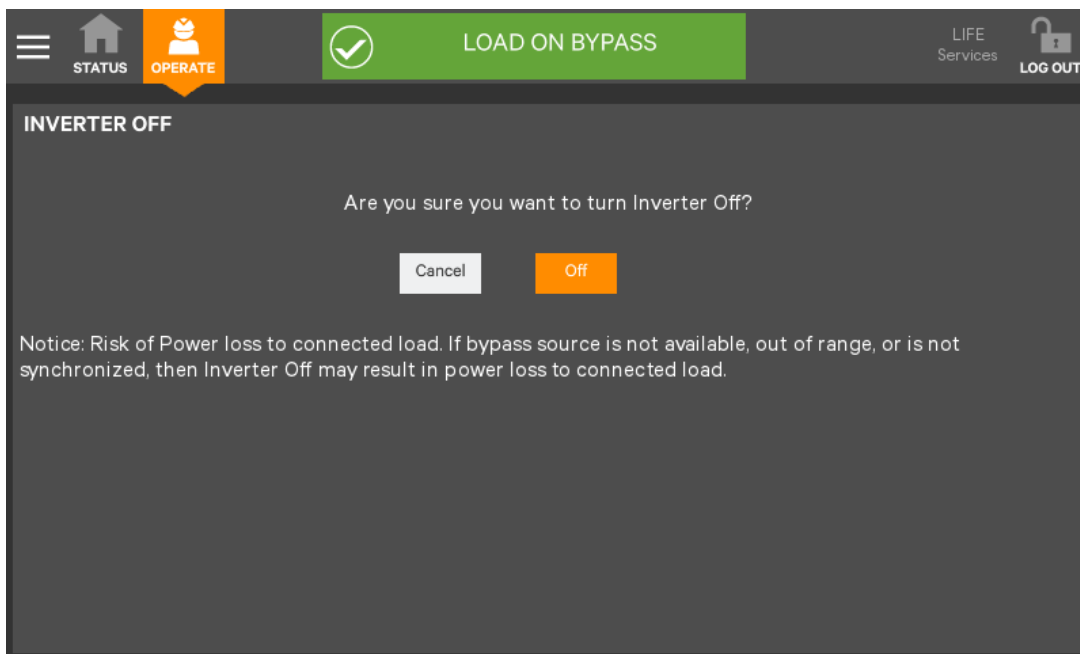

Figure 4-18 Inverter Off command

### Reset Fault

Faults may be reset with the Reset radio button.

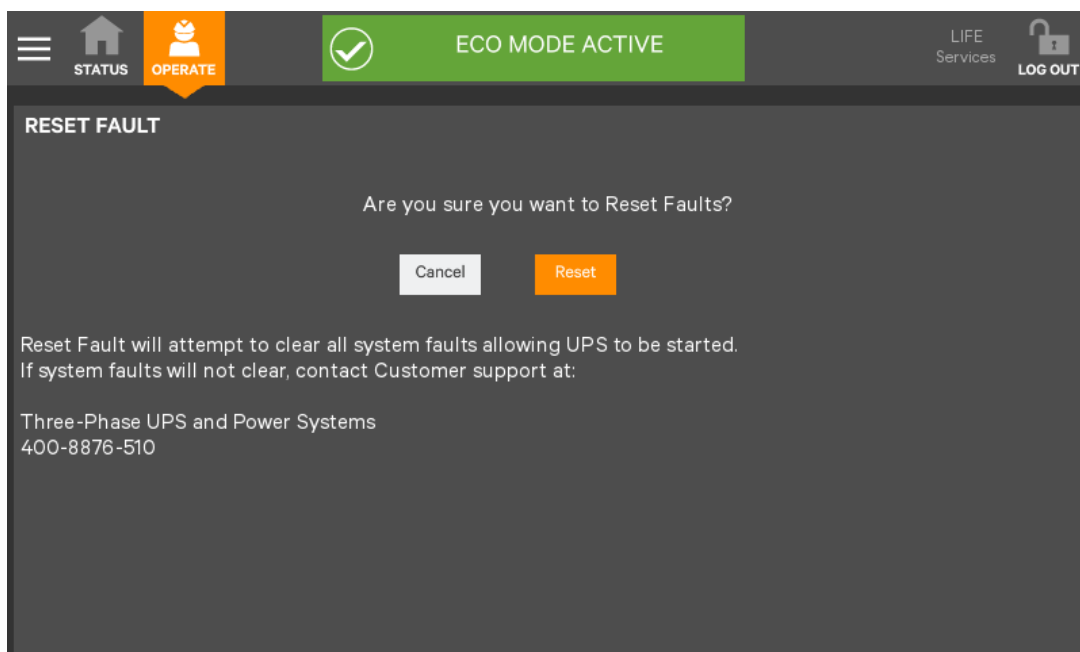

Figure 4-19 Reset fault command

Suspended Time Remaining

The Suspended Time Remaining box is not configurable. It is the time remaining when energy savings mode is suspended. It is active when energy saving mode has been going active and inactive too much and the system will suspended its activation for a period.

Module Redundancy Status

Module redundancy is usually chosen during system setup. Redundancy may be enabled only with Administrator or Service permissions. Proper operation requires the presence of at least a second module, but the system may encompass more modules.

To enable module redundancy:

1. Log in with Administrator or Setup permissions.
2. Touch the SETUP tab.
3. Touch the Context Menu icon and select UPS Settings.
4. In the Module Redundancy drop-down menu, touch Enable.
5. Touch the Save button to save the new setting or touch Cancel to exit without saving

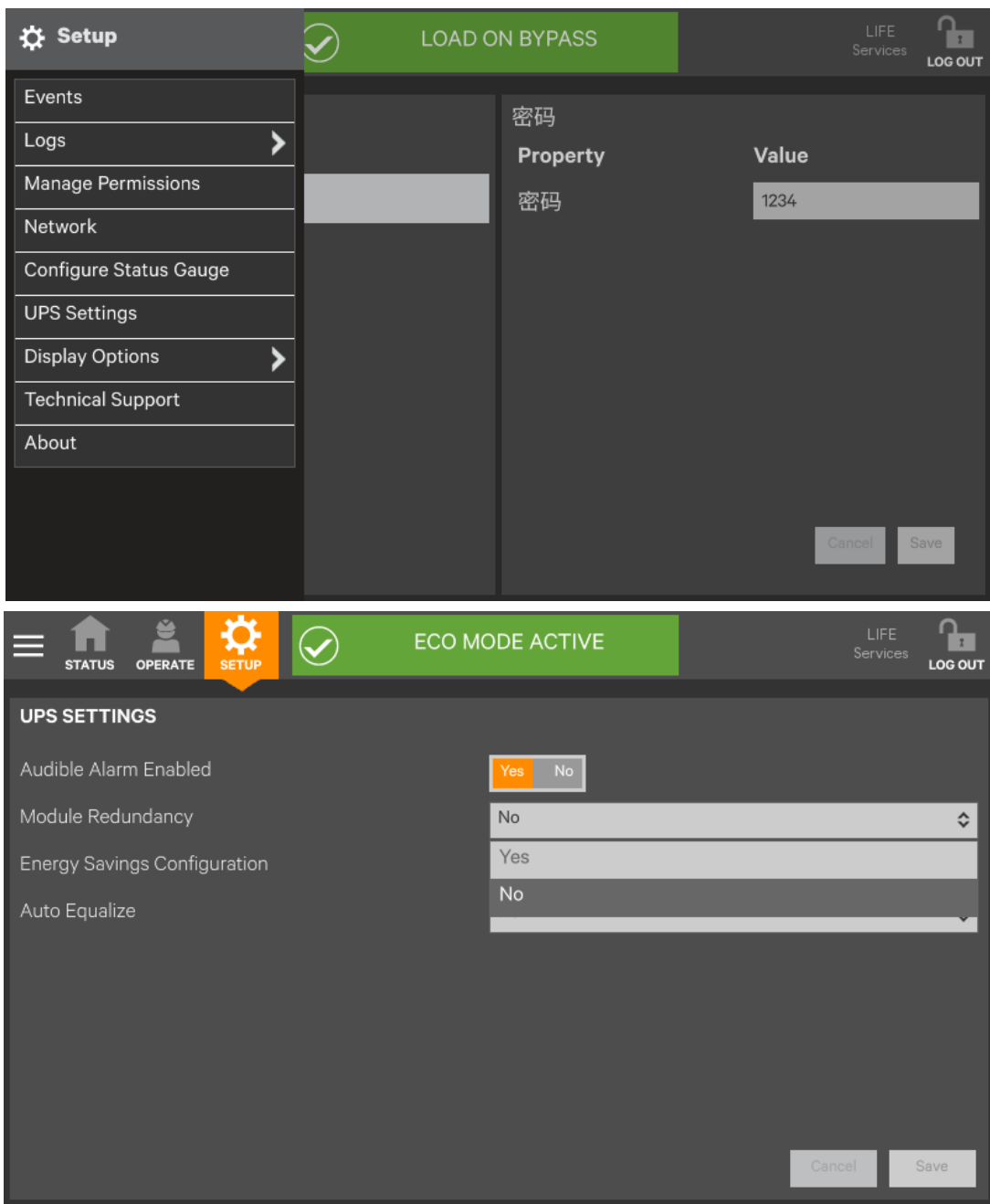

Figure 4-20 Enable module redundancy



## Energy Saving Mode Activation



### Note

Refer to the UPS manual before activating Energy Saving Mode. An Operator can only enable or disable Energy Saving Mode. The modes available vary according to the UPS type and system configuration. The types available must be set up by someone with either Administrator or Service access.

Energy Saving Mode may be activated or deactivated through the OPERATE menu screen. Two modes are available: Eco Mode and Intelligent Parallel Mode.

Eco Mode permits the UPS to reduce power consumption by powering the load through bypass power when utility-supplied power is within acceptable ranges. The inverter will remain in a state that will permit it to resume supplying power if the utility power goes outside acceptable ranges.

Intelligent paralleling puts units in a sleep mode until required.

To activate or deactivate Energy Saving Mode:

1. Touch the Setup radio button for Energy Saving Mode Activation.
2. Enable or disable Energy Saving Mode.
3. Touch the Save button. The Save button is inactive until the activation state is changed

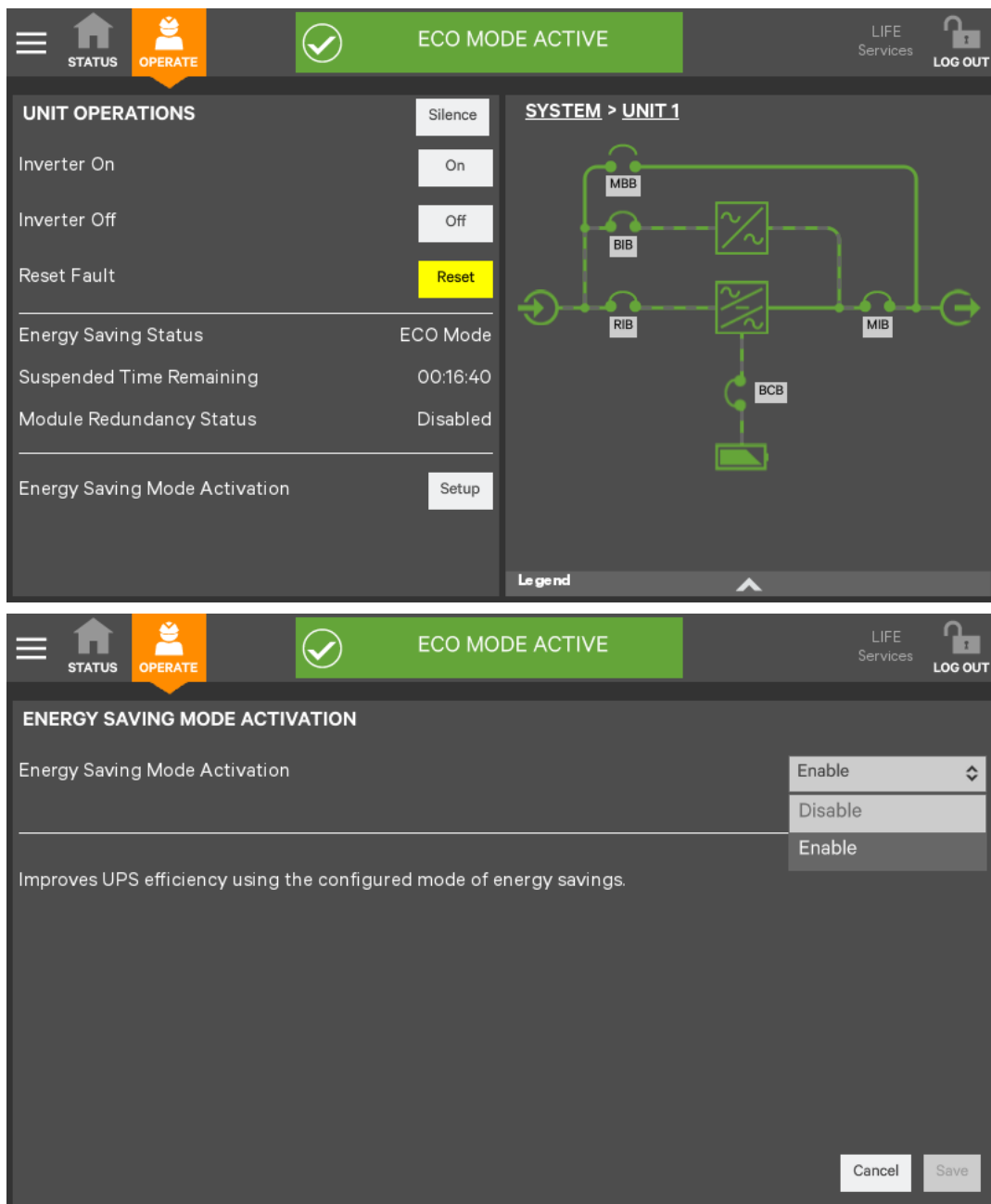

Figure 4-21 Activating Energy Saving Mode

## 4.4 Viewing UPS Status

The Liebert EXM Touchscreen Control Panel interface reports UPS status in multiple ways. The graphic views and text views will show the same readings.

Alarms and certain events will trigger audible alarms and the LED on the bezel, the light bar and the status header will change color. (Audible alarms will not sound unless enabled.) The scrolling information bar at the top of the interface summarizes information about the UPS status. The Status Gauge on the UNIT STATUS pane gives additional details about the UPS status

### 4.4.1 Viewing UPS Data With The Status Gauge

The Status Gauge offers a quick summary of the UPS's status. The information shown depends on the type of UPS and its configuration and upon the choices made in the gauge's setup. The data can be chosen by someone with Administrator or Service access.

The additional data will not replace the information shown in the center of the Status Gauge. Touching the center of the Status Gauge multiple times will cycle through the data.

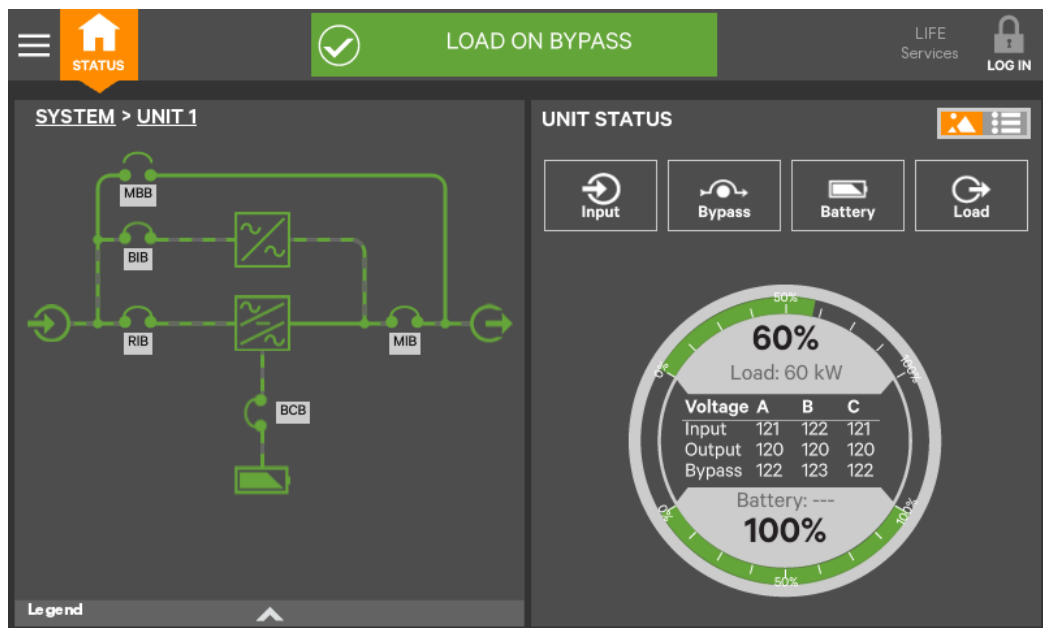

Figure 4-22 Default Status Gauge view

To change the values shown on the Status Gauge:

1. Log in with either Administrator or Service access.
2. Touch the SETUP menu icon.
3. Touch the Context menu icon.
4. Touch Configure Status Gauge. This opens the DIAL CONTROL SETUP pane, which holds settings for the readings in the center of the gauge and for the upper and lower metering.

To change the data shown in the center of the gauge:

- a. Expand the Center Readings menu by touching the arrow beside it.
- b. Put a check mark in the check box beside each value to be displayed (see Figures 4-23 and 4-24).

To change the data shown in the gauge's upper or lower section:

- a. Expand the Upper Meter or Lower Meter menu by touching the arrow beside it.
  - b. Use the drop-down menu to choose whether the Upper Meter or Lower Meter shows data for the Battery or Load. (Either the upper or lower part of the Status Gauge may be used to show Load or Battery readings.)
- c. Use the sliders to change the Warning Threshold or Critical Threshold (see Figures 4-23 and 4-24).
5. Touch the Save button to keep the changes or touch Cancel to exit without saving the changes.



#### Note

The DIAL CONTROL SETUP pane may be also be accessed by touching the Status Gauge and holding it for about 2 seconds. This requires Administrator or Service access.

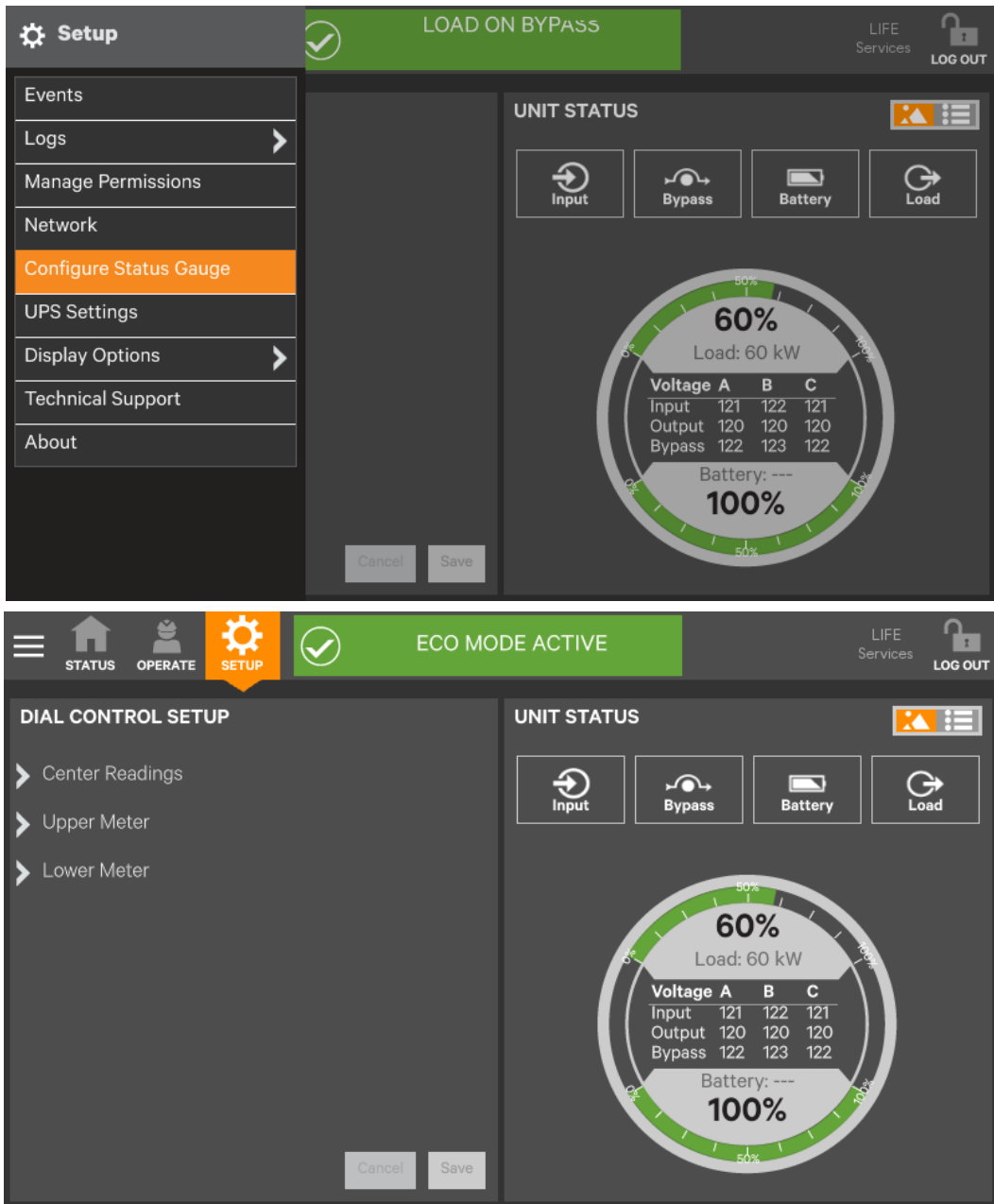

Figure 4-23 Access Status Gauge settings

**ECO MODE ACTIVE**

**DIAL CONTROL SETUP**

- Center Readings
  - Voltage(input, output, bypass)
  - Current(input, output, bypass)
  - kW(input, output, bypass)
  - kVA(input, output, bypass)
  - Load(kW, Current, kVA)
  - Load(kW, Voltage, Current)
  - Load(% Load, Current, kVA)
  - Load(% Load, Voltage, Current)
- Upper Meter

**UNIT STATUS**

Input Bypass Battery Load

60%  
Load: 60 kW

Voltage	A	B	C
Input	121	122	121
Output	120	120	120
Bypass	122	123	122

Battery: ---  
100%

Cancel Save

**LOAD ON BYPASS**

**DIAL CONTROL SETUP**

- Center Readings
- Upper Meter
  - Load
  - Warning Threshold: 66%  
10 % MIN 100 % MAX
  - Critical Threshold: 80%  
10 % MIN 105 % MAX
- Lower Meter

**UNIT STATUS**

Input Bypass Battery Load

60%  
Load: 60 kW

Voltage	A	B	C
Input	121	122	121
Output	120	120	120
Bypass	122	123	122

Battery: ---  
100%

Cancel Save

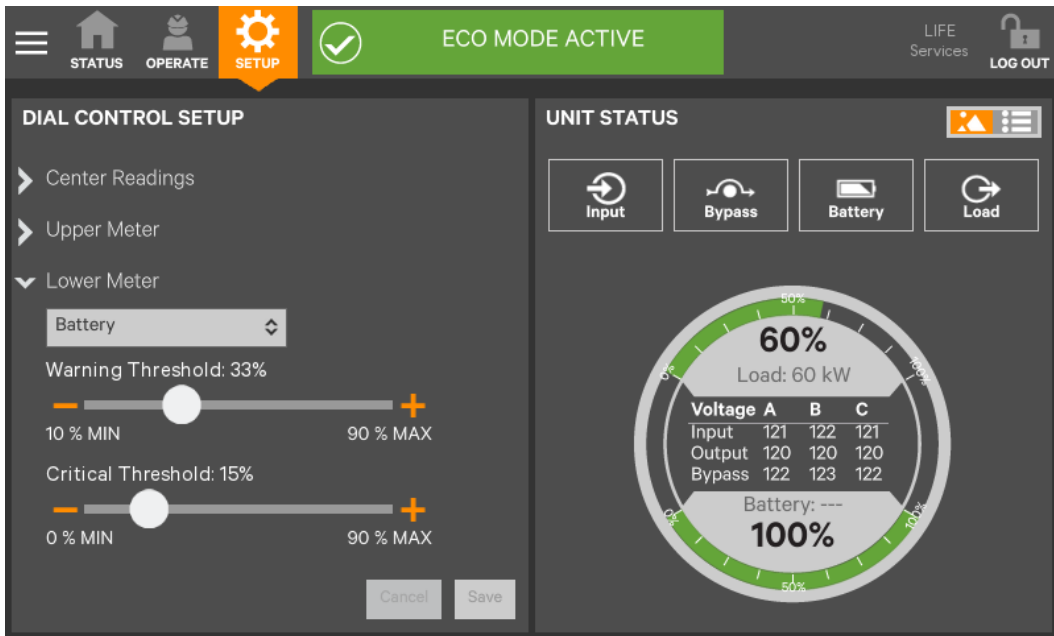

Figure 4-24 Status Gauge setting options

#### 4.4.2 Viewing UPS Data With The Status Panel

More-detailed information about the UPS’s status is readily available through the Status panel. Touching a component in the animated mimic display brings up data about the component on another pane. Touching a parameter icon on the UNIT STATUS pane brings up further details about that parameter.

The same data can be viewed by switching to the text view. The length of the lists and order of the details may require scrolling to find the desired data.



**Note**

A parameter must be visible on the graphic view of the UNIT STATUS screen for details to be viewed, even in the text view.

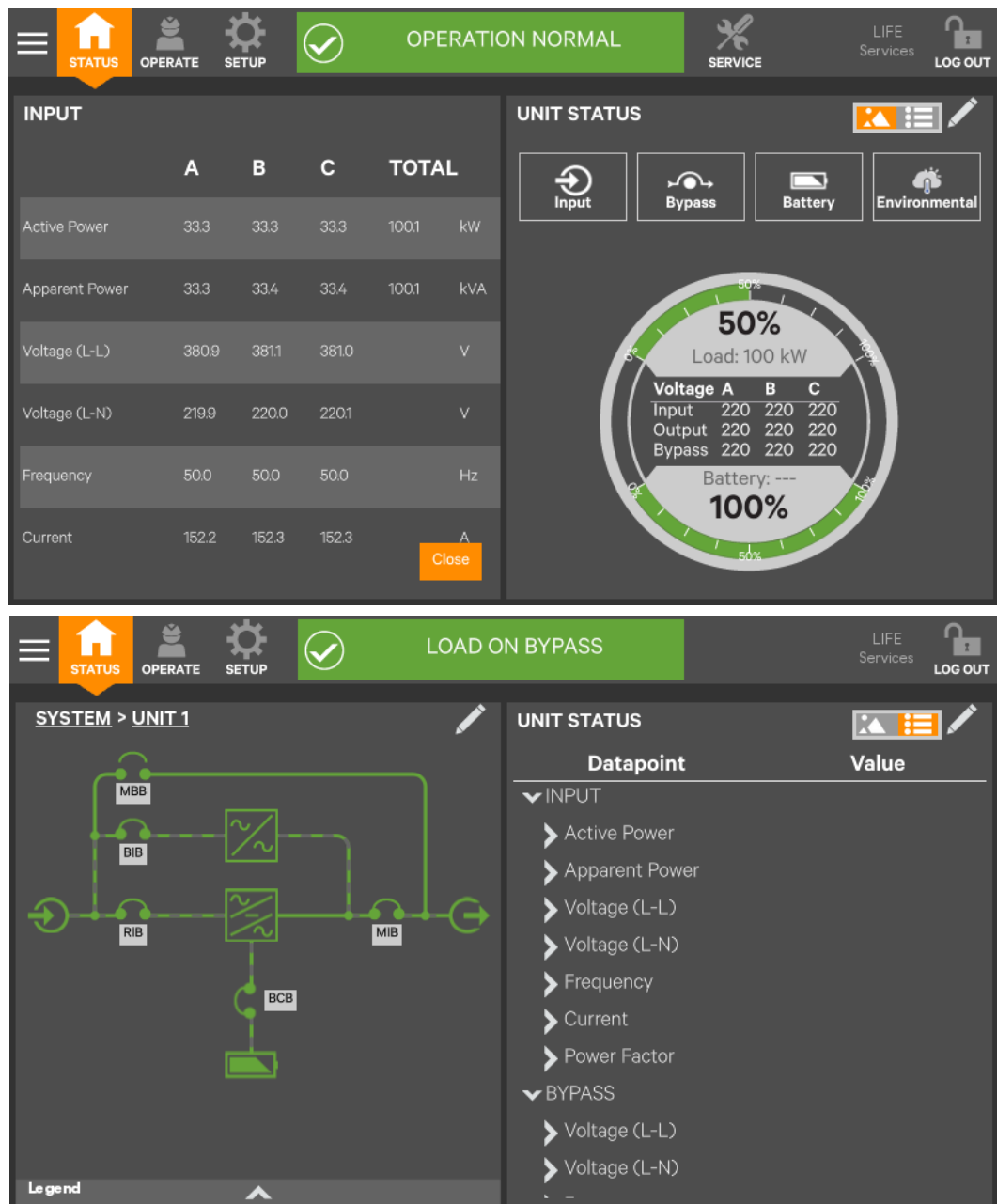

Figure 4-25 Unit status—Input details

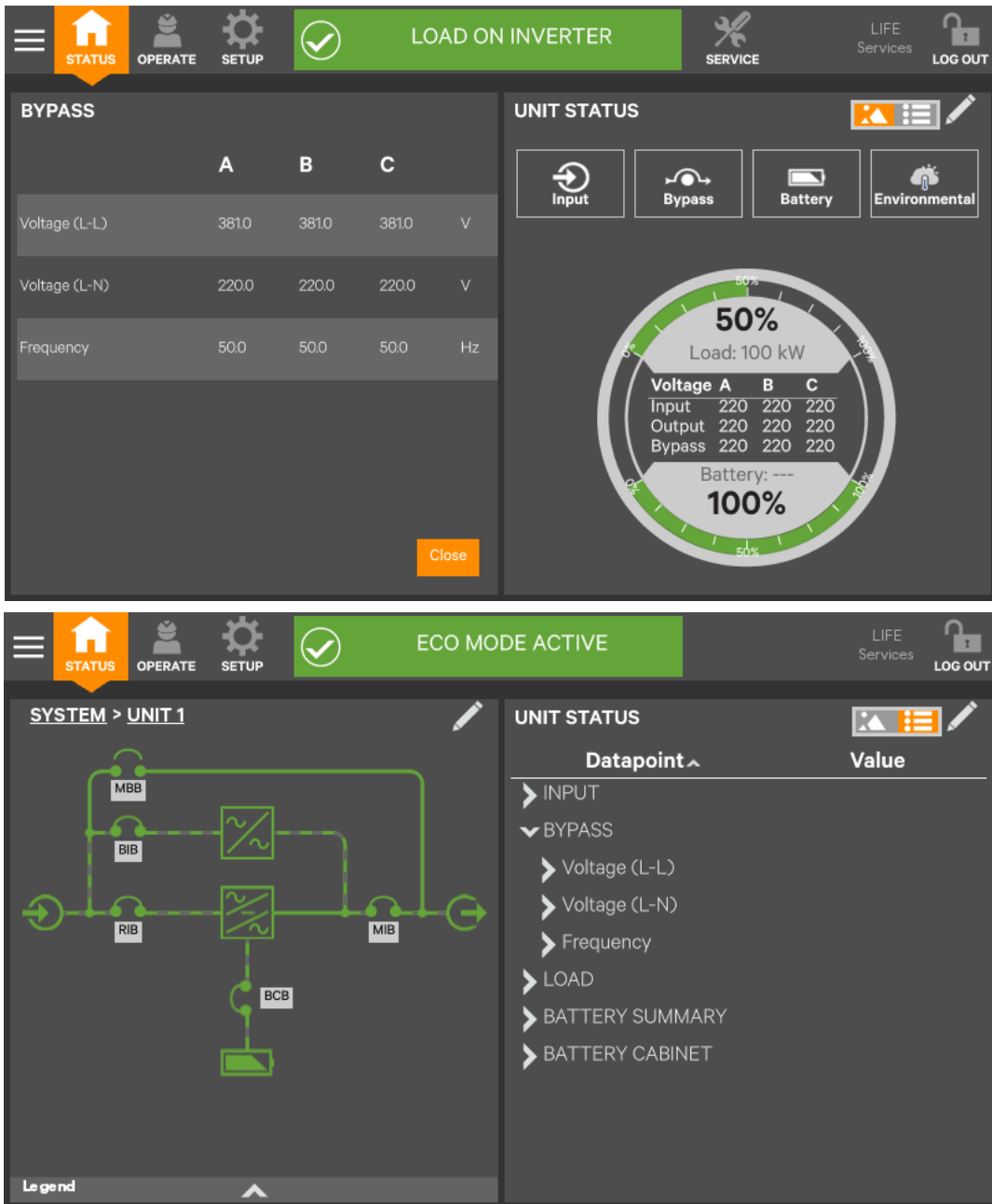

Figure 4-26 Unit status—Bypass details



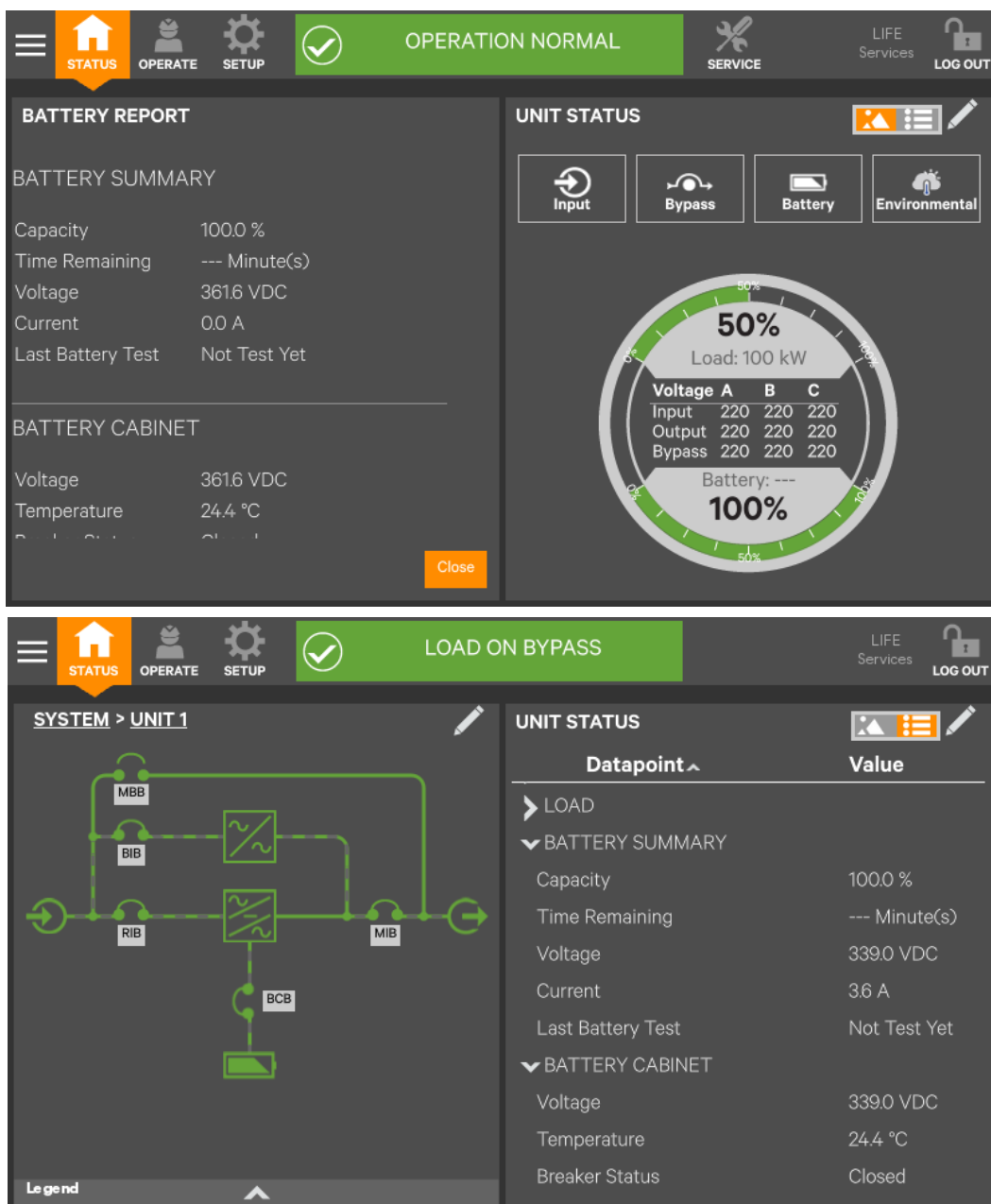

Figure 4-27 Unit status—Battery details

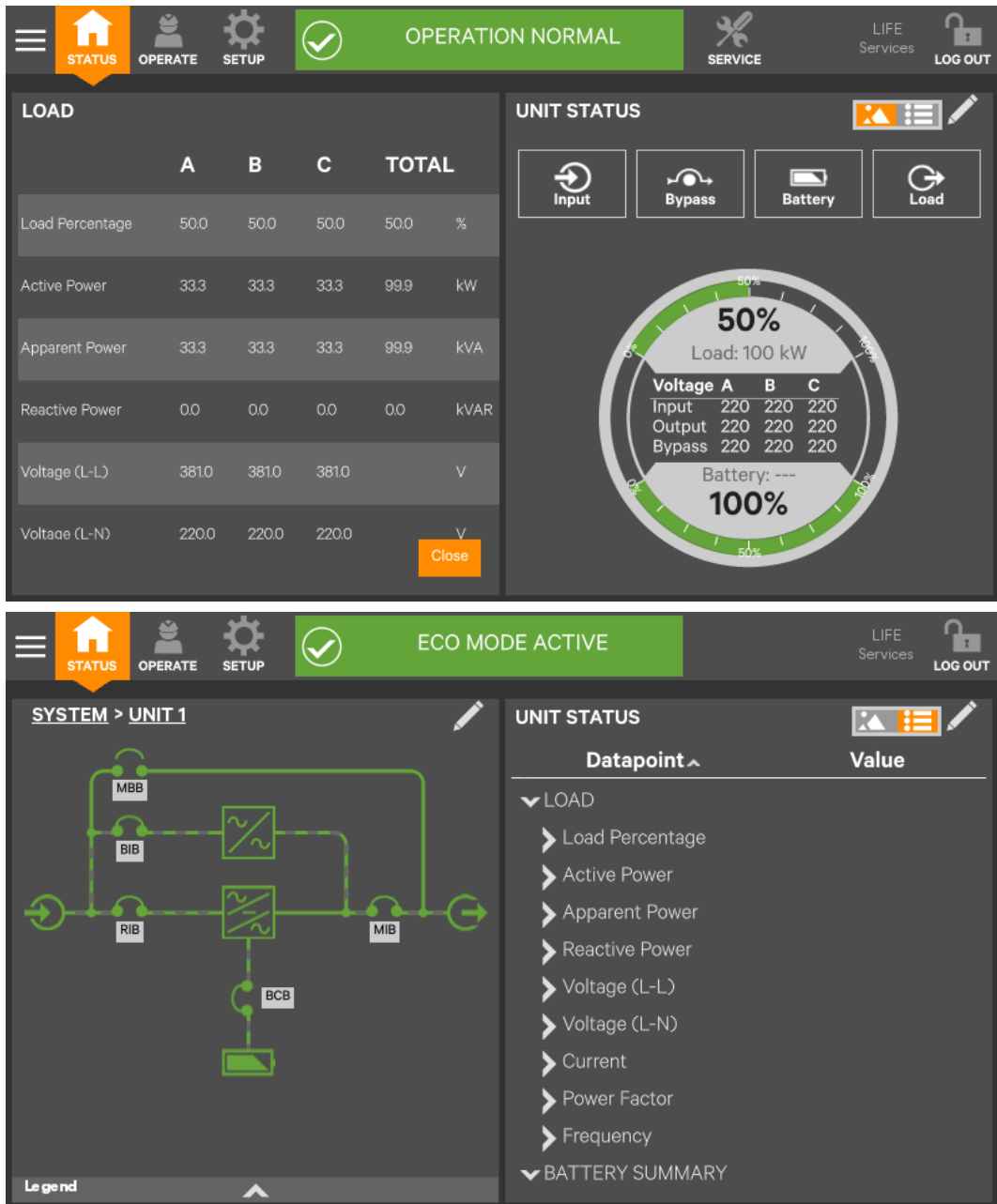

Figure 4-28 Unit status—Load details

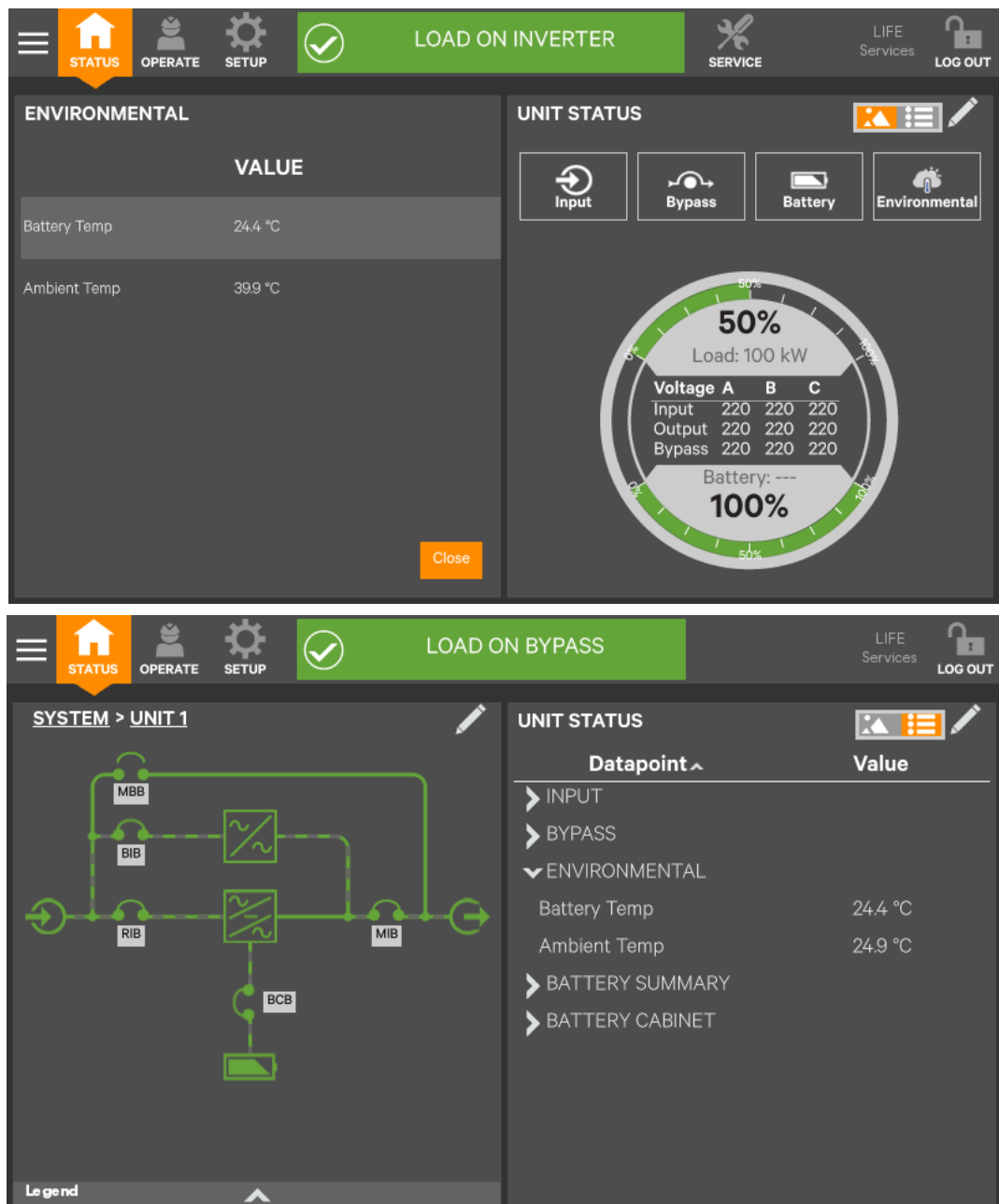



Figure 4-29 Unit status—Environmental details

#### 4.4.3 Logs—Alarms And Events

The Context Menu, when opened from the STATUS pane, permits viewing logs of alarms and events that have occurred on the UPS. Both logs include the date and time of occurrence, type, an ID, component affected and a description of the alarm or event. The information is available to Observers, those without a log in passcode.

To view the alarms or events:



1. Navigate to the STATUS pane , if required.
2. Touch the Context Menu icon.
3. Touch the log to view, alarms or events; refer to Figure 4-30.

Touching Alarms immediately opens the list of alarms; touching Logs requires touching the UPS Event Log screen.

The figure consists of two screenshots of a web-based operator control and display panel. Both screenshots feature a top navigation bar with a 'STATUS' button, a green status indicator, and 'LIFE Services' with a 'LOG IN' button.

**Top Screenshot: LOAD ON BYPASS**

The status bar shows a green box with a checkmark and the text 'LOAD ON BYPASS'. Below it, the 'EVENTS' section has 'Silence' and 'Filter' buttons. The table below lists the following events:

Date/Time	Type	Event ID	Component	Description
19/1/9 AM1:57	✓	162	MON	Load on Bypass
19/1/9 AM1:57	✓	550	MON	ECO Mode Active
19/1/9 AM1:57	✓	542	MON	ECO Mode Enabled
19/1/9 AM1:57	✓	516	MOD1	Module Comms Normal
19/1/9 AM1:57	✓	516	BYP	Module Comms Normal

**Bottom Screenshot: ECO MODE ACTIVE**

The status bar shows a green box with a checkmark and the text 'ECO MODE ACTIVE'. Below it, the 'EVENT LOG' section has an 'Export' button. The table below lists the following event logs:

Date/Time	Type	ID	Status	Component	Description
19/1/9 AM1:57	Info	162	Set	MON	Load on Bypass
19/1/9 AM1:57	Info	516	Set	MOD1	Module Comms Normal
19/1/9 AM1:57	Info	516	Set	BYP	Module Comms Normal
19/1/9 AM1:57	Info	550	Set	MON	ECO Mode Active
19/1/9 AM1:57	Info	542	Set	MON	ECO Mode Enabled
19/1/9 AM12:23	Warning	90	Clr	MON	Ambient Overtemperature
19/1/9 AM12:21	Info	550	Set	MON	ECO Mode Active
19/1/9 AM12:20	Info	542	Set	MON	ECO Mode Enabled

Figure 4-30 View alarms or events

## 4.5 Viewing UPS Component Status

The animated mimic screen permits viewing details about the main components installed and configured in the UPS. The data list opens on the opposite side of the screen and, for most parameters, expands to show all details for the component touched.

The same component information can be obtained by going to the Status -> Components menu.

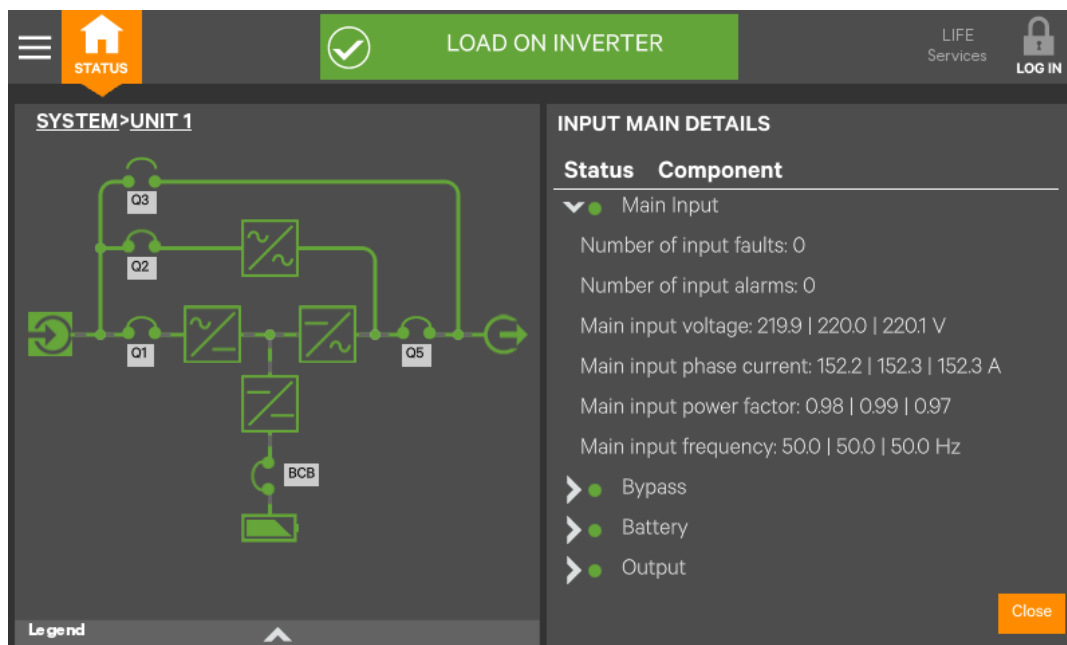

Figure 4-31 Unit status—Input details

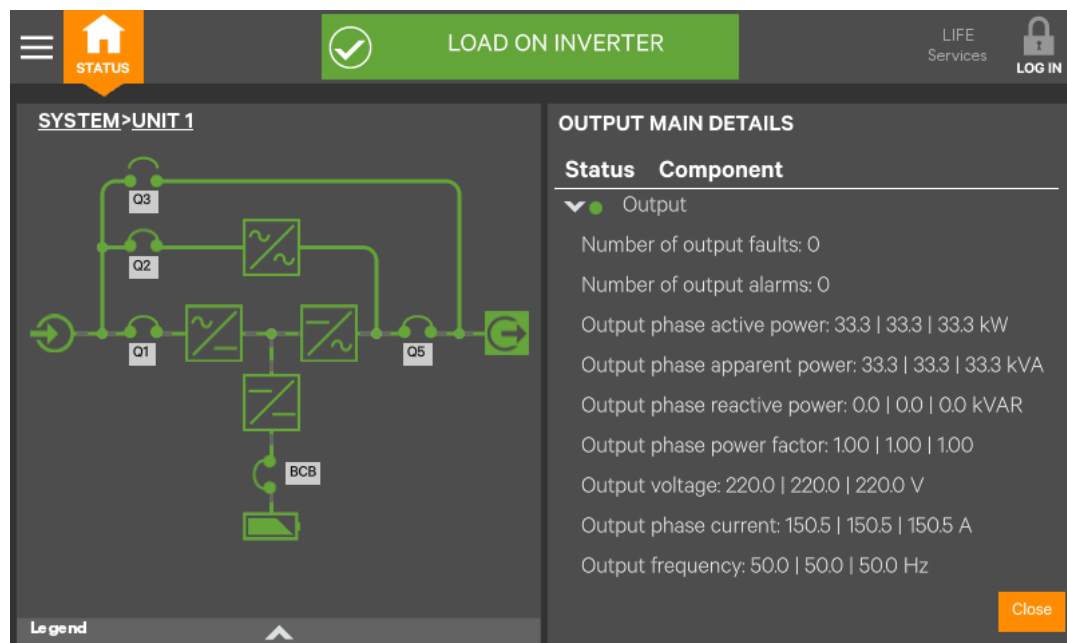

Figure 4-32 Unit status—Output details

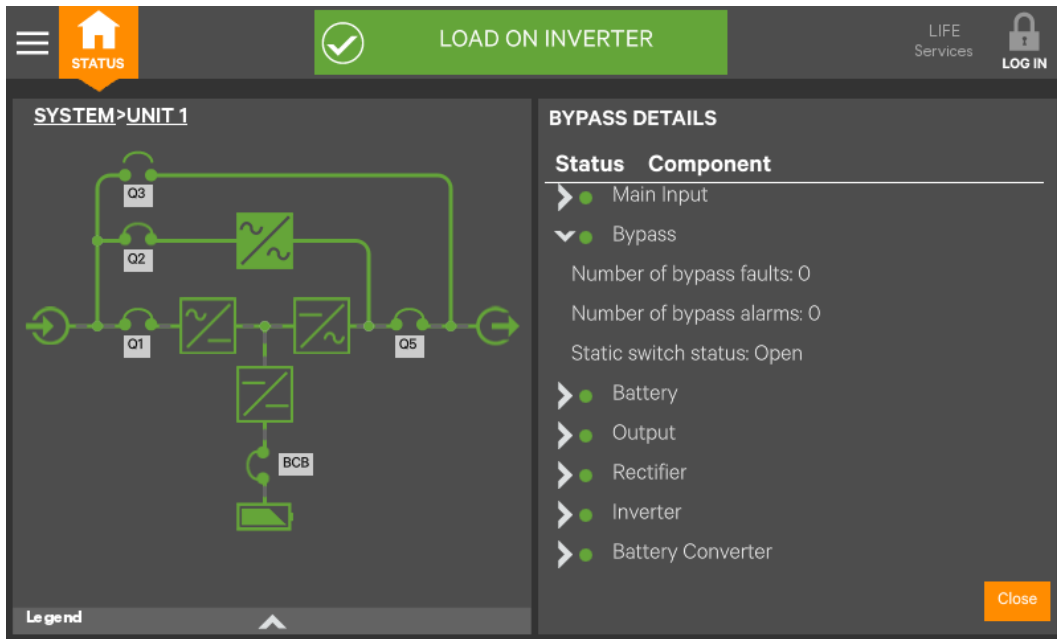

Figure 4-33 Unit status—Bypass details

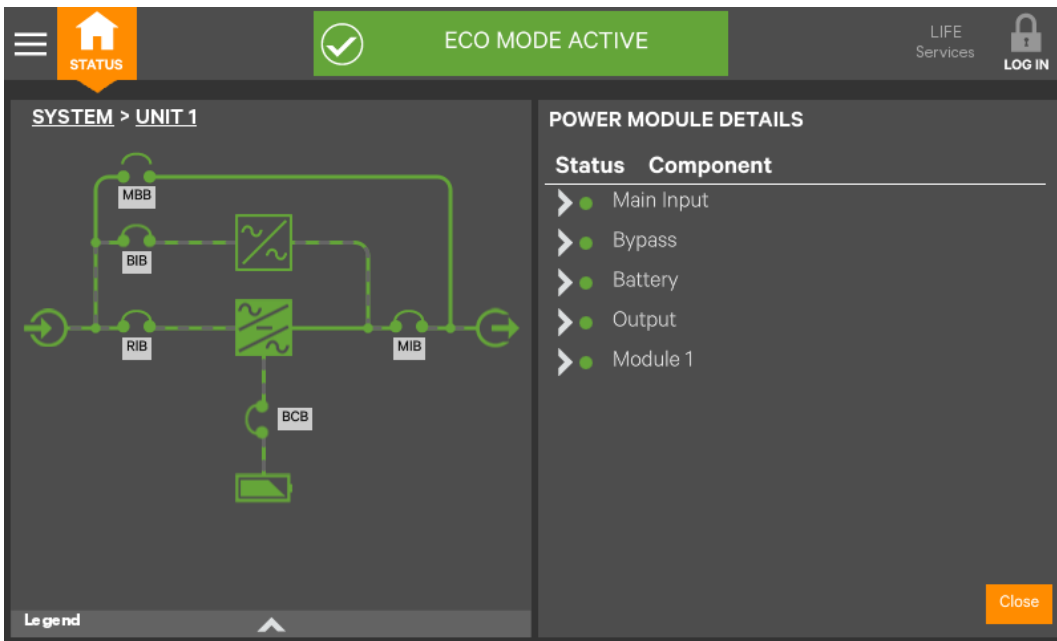

Figure 4-34 Unit status—Power module details

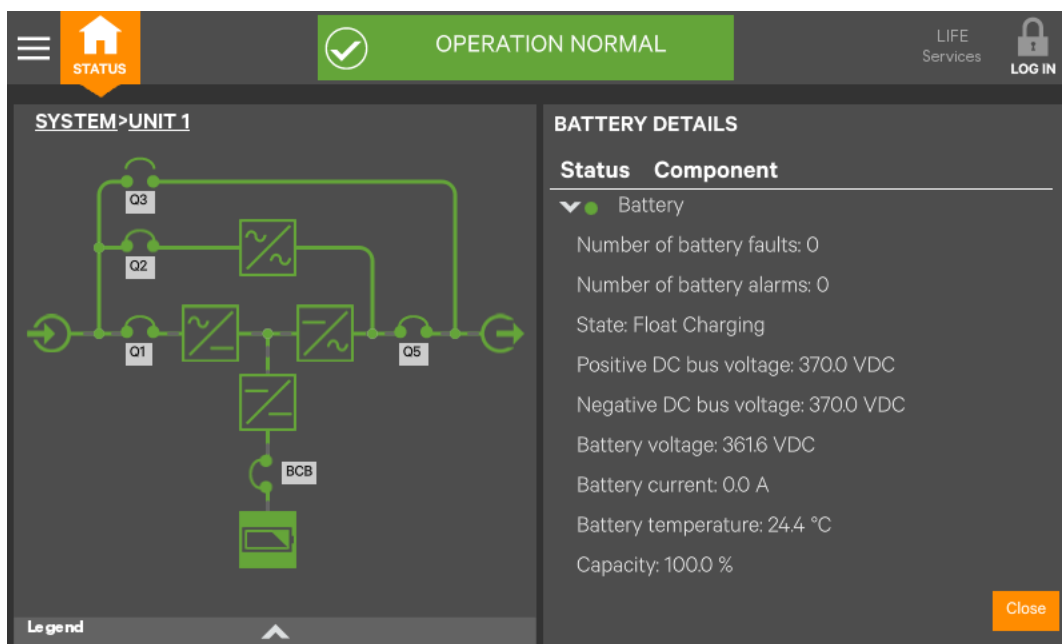

Figure 4-35 Unit status—Battery details

## 4.6 Status Bar Component

The status bar indicates UPS status by:

- scrolling messages to inform viewers; see Tables 4-1 through 4-3.
- changing color; green for normal, yellow for warning and red for alarm.
- showing an icon inside the bar; shown at right.

### 4.6.1 Status Bar Messages



Up to three messages may scroll through the status bar to the right of the status icon. Each message will have a duration of four seconds, except they change immediately if the system’s status changes.

Table 4-1 Normal status messages

Message 1	Message 2	Message 3	Definition
Load on inverter	Frequency converter mode active	Output frequency X Hz	This system is in normal operating mode, supplied by the inverter and operating as a frequency converter
Load on inverter	Energy saving mode active	/	This system is in normal operating mode, supplied by the inverter, and has one of the energy saving modes active
Load on inverter	Operation normal	/	This system is in normal operating mode, supplied by the inverter, and has no special configurations
Load on bypass	Energy saving mode active	/	This system is in normal operating mode, supplied by the bypass, and has one of the energy saving modes active
Load on battery	Battery test in progress	/	This system is in normal operating mode, supplied by the inverter via the battery, and a battery test is actively running
Load off	Energy saving mode active	/	This system is in normal operating mode, load not supplied by this unit, and has one of the energy saving modes active
Load on inverter	Test mode active	/	This system is in normal operating mode, for the test mode that is activated

Table 4-2 Warning status messages

Message 1	Message 2	Message 3	Definition
LOAD ON INVERTER	OUTPUT OVERLOAD	—	This system is in warning operating mode, supplied by the inverter, and the system is in overload. This means the system will go off inverter at some point
LOAD ON INVERTER	ALARM ACTIVE – WARNING	VIEW ALARM LOG FOR DETAILS	This system is in warning operating mode, supplied by the inverter, and has an active warning. This means the system is operating, but something was detected to be outside of normal
LOAD ON BYPASS	LOAD MANUALLY TRANSFERRED TO BYPASS	LOAD UNPROTECTED	This system is in warning operating mode, supplied by the bypass. The user transferred the load to the bypass so the system cannot protect itself from source variations
LOAD ON BATTERY	X MINUTES REMAINING	—	This system is in warning operating mode, supplied by the inverter via the battery. There are X minutes of calculated run time remaining. This is used before the battery low-voltage warnings are generated
LOAD ON BYPASS	ALARM ACTIVE – WARNING	VIEW ALARM LOG FOR DETAILS	This system is in warning operating mode, supplied by the bypass, and has an active warning. This means the system is operating after a transfer to bypass and something was determined to be outside normal range
LOAD ON INVERTER	ENERGY SAVING MODE ACTIVE	ALARM ACTIVE – WARNING	This system is in warning operating mode, supplied by the inverter, one of the energy saving modes is active, and has an active warning. This means the system is operating, but something was determined to be outside normal range
LOAD ON BYPASS	ENERGY SAVING MODE ACTIVE	ALARM ACTIVE – WARNING	This system is in warning operating mode, supplied by the bypass, one of the energy saving modes is active, and has an active warning. This means the system is operating, but something was determined to be outside normal range
LOAD OFF	ENERGY SAVING MODE ACTIVE	ALARM ACTIVE – WARNING	This system is in warning operating mode, load off, one of the energy saving modes is active, and has an active warning. This means the system is operating, but something was determined to be outside normal range
LOAD ON INVERTER	TEST MODE ACTIVE	ALARM ACTIVE – WARNING	This system is in warning operating mode, supplied by the inverter, running in a system test mode, and has an active warning. This means the system is in TEST MODE, and something was determined to be outside normal test operations
LOAD ON BYPASS	TEST MODE ACTIVE	ALARM ACTIVE – WARNING	This system is in warning operating mode, supplied by the bypass, running in a system test mode, and has an active warning. This means the system is in TEST MODE, and something was determined to be outside normal test operation
LOAD ON BATTERY	TEST MODE ACTIVE	ALARM ACTIVE – WARNING	This system is in warning operating mode, supplied by the battery, running in a system test mode, and has an active warning. This means the system is in TEST MODE, and something was determined to be outside normal test operations
LOAD ON INVERTER	FREQUENCY CONVERTER MODE ACTIVE	ALARM ACTIVE – WARNING	This system is in warning operating mode, supplied by the inverter, operating as a frequency converter, and has an active warning. This means the system is operating, but something was determined to be outside normal range

Table 4-3 Critical status messages

Message 1	Message 2	Message 3	Definition
LOAD ON INVERTER	OUTPUT OVERLOAD	TRANSFER TO BYPASS PENDING	This system is in critical operating mode, supplied by the inverter, and the load is about to be transferred to the bypass due to overload timeouts
LOAD ON INVERTER	ALARM ACTIVE – CRITICAL	VIEW ALARM LOG FOR DETAILS	This system is in critical operating mode, supplied by the inverter. There is a critical fault in the system that the user needs to view
LOAD ON BYPASS	LOAD AUTOMATIC	VIEW ALARM LOG FOR	This system is in critical operating mode, supplied by the bypass. The system moved the load to the bypass due to



Message 1	Message 2	Message 3	Definition
	LLY TRANSFERRE D TO BYPASS	DETAILS	a critical fault in the system
LOAD ON BYPASS	ALARM ACTIVE – CRITICAL	VIEW ALARM LOG FOR DETAILS	This system is in critical operating mode, supplied by the bypass. The system is running on bypass not due to auto-transfer, and a critical fault is active in the system
LOAD ON BATTERY	X MINU TES REM AININ G	LOAD SHUTDOWN IMMINENT	This system is in critical operating mode, supplied by the inverter via the battery. The battery is extremely low and the load will turn Off or transfer to bypass soon
LOAD OFF	ALARM ACTIVE – CRITICAL	VIEW ALARM LOG FOR DETAILS	This system is in critical operating mode, load not supplied by this unit. The load is not supplied for any reason and a critical fault is active
LOAD OFF	—	—	This system is in critical operating mode, load not supplied by this unit. The load is not supplied and no active fault is present
LOAD ON BATTERY	ALARM ACTIVE – CRITICAL	VIEW ALARM LOG FOR DETAILS	This system is in critical operating mode, supplied by the battery. The system is running on inverter via the battery, is not in imminent shutdown and a critical fault is active in the system
LOAD OFF	SERVICE MODE ACTIVE	—	This system is Off with a service mode active
LOAD ON INVERTER	ENERGY SAVING MODE ACTIVE	ALARM ACTIVE – CRITICAL	This system is in critical operating mode, supplied by the inverter. The system is running on inverter, with an energy saving mode active and a critical fault is active in the system
LOAD ON BYPASS	ENERGY SAVING MODE ACTIVE	ALARM ACTIVE – CRITICAL	This system is in critical operating mode, supplied by the bypass. The system is running on bypass, with an energy saving mode active and a critical fault is active in the system
LOAD OFF	ENERGY SAVING MODE ACTIVE	ALARM ACTIVE – CRITICAL	This system is in critical operating mode. The system is NOT running, with an energy saving mode active and a critical fault is active in the system
LOAD OF	TEST MODE ACTIVE	—	This system is off with a TEST MODE active
LOAD ON INVERTER	TEST MODE ACTIVE	ALARM ACTIVE – CRITICAL	This system is in critical operating mode, supplied by the inverter, running in a system test mode, and has an active fault. This means the system is in TEST MODE and something critical was determined to be outside normal test operations
LOAD ON BYPASS	TEST MODE ACTIVE	ALARM ACTIVE – CRITICAL	This system is in critical operating mode, supplied by the bypass, running in a system test mode, and has an active fault. This means the system is in TEST MODE, and something critical was determined to be outside normal test operation
LOAD ON BATTERY	TEST MODE ACTIVE	ALARM ACTIVE – CRITICAL	This system is in critical operating mode, supplied by the inverter via the battery, running in a system test mode, and has an active fault. This means the system is in TEST MODE, and something critical was determined to be outside normal test operation
LOAD OFF	TEST MODE ACTIVE	ALARM ACTIVE – CRITICAL	This system is in critical operating mode, with LOAD OFF, running in a system test mode, and has an active fault. This means the system is in TEST MODE, and something critical was determined to be outside normal test operation
LOAD ON INVERTER	FREQUENCY CONVERTER MODE ACTIVE	ALARM ACTIVE – CRITICAL	This system is in critical operating mode, supplied by the inverter, operating as a frequency converter, and has an active fault. This means the system is operating, but something critical was determined to be outside normal range

Message 1	Message 2	Message 3	Definition
LOAD OFF	FREQUENCY CONVERTER MODE ACTIVE	ALARM ACTIVE - CRITICAL	This system is in critical operating mode, load NOT supplied, operating as a frequency converter and has an active fault. This means the system is operating, but something critical was determined to be outside normal range

## 4.7 Alarm List

Table 4-4 provides the complete list of UPS alarm messages for display either on the 'Event' menu or on the 'Records' menu.

Table 4-4 Alarm list

Alarm	Explanation
Fault Clear	FAULT CLEAR key on the operator control and display panel pressed
Rectifier in Setting	The rectifier starts up and is in synchronization
Inverter in Setting	The inverter starts up and is in synchronization
Inverter Manual On	INVERTER ON key on the operator control and display panel pressed to turn on the inverter
Inverter Manual Off	INVERTER OFF key on the operator control and display panel pressed to turn off the inverter
Turn On Fail	The inverter failed to turn on when the INVERTER ON key is pressed. This may be the result of an invalid operation (maintenance bypass switch closed) or DC bus or rectifier not ready
Rec. Soft Start Fail	Owing to low DC bus voltage, the rectifier will report this alarm
Silence Active	SILENCE ON/OFF key on the operator control and display panel pressed
Silence Inactive	SILENCE ON/OFF key on the operator control and display panel pressed in alarm silence state
Bypass Mode	The UPS is in bypass mode
Normal Mode	The UPS is in normal mode
Battery Mode	The UPS is in battery mode
Check UPS Output	UPS shutdown with no output power
Output Disabled	EOD event happened. Check the battery voltage
Other Bypass STS Fail	The adjacent bypass STS open circuit fault or short-circuit fault
Input Voltage Abnormal	The mains voltage is outside specifications and results in rectifier shutdown
Input Undervoltage	At least one phase main input voltage is within 132V ~ 176V, thus the load should be derated
Input Freq. Abnormal	The mains frequency is outside specifications and results in rectifier shutdown
Input Phase Reversed	The AC input phase rotation is reversed
Input Backfeed	Battery voltage fed back to rectifier input
Input Neutral Lost	AC rectifier input neutral line not detected
Input Current Abnormal	Battery load sharing imbalance or rectifier input current abnormal
Input Current Limit	Input current over limit
Bypass Unable to Trace	The bypass frequency is outside specifications. This alarm automatically resets once the bypass voltage goes normal
Bypass Abnormal	The amplitude or frequency of the bypass voltage exceeds the limit. This alarm automatically resets once the bypass voltage returns to normal
Bypass STS Fail	At least one of the STSs at the bypass side is open or shorted. This fault is locked until power-off
By. Abnormal Shutdown	Both the bypass and inverter voltages are abnormal, and the output is off
Bypass Phase Reversed	The phase rotation of the bypass voltage is reversed
Bypass overcurrent	The bypass current is outside the rated current
Bypass backfeed	The bypass backfeed is faulty
Bypass Overtemperature	The bypass has overtemperature
Bypass in Charge	The bypass detects an inverter signal when the system runs normally. When the output voltage is abnormal, the system will transfer to bypass mode for power supply
Bypass Neutral Lost	The bypass lacks of N
Bypass in Setting	The bypass module is initialized and synchronized
Rectifier Fault	Bus voltage abnormal or battery SCR short circuit
DC Bus Overvoltage	The rectifier, inverter and battery converter shut down because the DC bus voltage is too high. The load transfers to bypass
DC Bus Abnor. Shutdown	The DC bus voltage is abnormal and results in inverter shutdown. The load transfers to bypass
Inverter Asynchronous	The output voltage and bypass voltage are misaligned in phase. This alarm resets automatically once the condition is no longer true

Alarm	Explanation
Inverter Fault	Inverter output voltage outside specifications. Load transfers to bypass
Inverter Relay Fail	At least one of the inverter relays is opened or shorted. This fault is locked until mains power-off
Output Fuse Fail	At least one of the inverter output fuses is blown
Output Volt. Abnormal	At least one phase of the output voltages is abnormal
Output Overload	This alarm appears when the load arises above 105% of the nominal rating. The alarm automatically resets once the overload condition is removed
System Overload	This alarm appears when the total load rises above 105% of the nominal rating of the parallel system. The alarm automatically resets once the overload condition is removed
Out. Overload Timeout	The UPS overload status continues and the overload times out. When the time has expired, the load automatically transfers to the bypass
Load Impact Transfer	A transfer to bypass occurred due to a large step load. The UPS can recover automatically. Turn on the load equipment in stages to reduce the load impact on the inverter
Excess Auto Rexfers	The load remains on bypass power owing to excessive number of transfers that occurred within the one hour
Excess ECO Auto Xfers	The load remains on bypass power owing to excessive number of transfers that occurred within the one hour
Load Sharing Abnormal	The UPSs in a parallel system are not sharing the load current correctly
Other Module Xfer	All UPSs in the parallel system transfer to bypass at the same time when one of them needs to transfer to bypass. This message appears on the TOUCHSCREEN of the UPS with passive transfer to bypass
Control Power Fail	The auxiliary power failure or power-off
EPO	EPO button on operator control and display panel pressed or external EPO command received
Fan Abnormal	At least one fan has fault
Operation Invalid	Maintenance bypass switch is closed when the parallel system is on inverter, or output switch and maintenance bypass switch are closed when the inverter is on
LBS Active	The LBS setting is active
LBS Abnormal	LBS is abnormal
Input Switch Open	Input switch is open
Maint. Switch Open	Maintenance bypass switch is open
Maint. Switch Closed	Maintenance bypass switch is closed
Bypass Switch Open	Bypass switch is open
Output Switch Open	Output switch is open
Charger Fault	Battery charger has failure
Discharger Curr. Limit	Discharge current is over limit, close the discharger
Autostart	After UPS shutdown at EOD, the inverter automatically starts upon mains restoration
Batt. Equalize Charge	The battery is forced to be in boost charge state
Rectifier DSP Update	Rectifier DSP software being updated
Rectifier FPGA Update	Rectifier FPGA software being updated
Inverter DSP Update	Inverter DSP software being updated
Inverter FPGA Update	Inverter FPGA software being updated
Bypass DSP Update	Bypass DSP software being updated
Bypass FPGA Update	Bypass FPGA software being updated
Monitor Update	Monitoring software being updated
Flash Operate Fail	Historical record not saved
Remote Turn On	Turn on the inverter through the service command
Remote Turn On Fail	Caused by invalid operation (maintenance bypass switch closed), DC bus or rectifier not ready
Remote Turn Off	Turn off the inverter through the service command
No Battery	Check the battery and battery connection
Discharger Fault	Bus voltage abnormal
Battery Reversed	Reconnect battery and check battery wiring
Battery Period Testing	The battery is under automatic periodic battery maintenance test (20% capacity discharge)
Batt. Capacity Testing	The user initiated a battery capacity test (100% capacity discharge)
Batt. Maint. Testing	The user initiated a maintenance test (20% capacity discharge)
Batt. End of Discharge	Inverter turned off due to battery EOD
Battery Overtemp.	The battery temperature is over limit
Low Battery Warning	Before the EOD, battery low pre-warning will occur. After this pre-warning, the battery will have the capacity for 3min discharging with full load. The time is user-settable from 3min to 6min

Alarm	Explanation
On Generator	Dry contact signal, indicating generator connected
Battery Maintain	Capacity of the battery
Battery Ground Fault	Battery has ground fault
Batt. Room Temp. Abn.	Battery room has overtemperature (option included)
BCB1 Status Abnormal	Logic conflict between BCB1 drive signal and backfeed signal
BCB1 Closed	BCB1 state (closed)
BCB1 Open	BCB1 state (open)
Phase A Out. Fuse Fail	Check that the wire jumper on the X3 board is correct
Phase B Out. Fuse Fail	Check that the wire jumper on the X3 board is correct
Phase C Out. Fuse Fail	Check that the wire jumper on the X3 board is correct
Equalize Chg. Timeout	The actual float charging time exceeds the time set by the setting software
MonCAN Comm. Abnor.	Communication failure among internal monitoring board and inverter, rectifier and bypass
ParaMonCAN Comm.Abnor.	Communication fault between racks
PowerCAN Comm. Abnor.	Communication failure among inverter, rectifier and bypass
ParaPowerCANCommAbnor.	Communication failure between different UPSs in parallel system. Check if any UPS is not powered on or parallel cables are not well connected, then clear the fault to restart the UPS
Discr.Bus Comm.Abnor.	Communication failure between discrete bus inside the rack. It is recommended to confirm that the rear communication cables connection inside the rack is reliable
ParaDiscrBusCommAbnor.	Communication failure between discrete bus inside the rack. It is recommended to confirm that the rear communication cables connection inside each rack is reliable, and that the bypass module is fixed
Ambient Overtemp.	The overtemperature detection of ambient temperature, which can be set through the setting software
By. SCR Fan Abnormal	The internal fan of bypass module is faulty
Top-outlet Fan Abnor.	The fan of top air outlet is faulty
System Interrupt Xfer	Execute the interval transfer under conditions of bypass unable to trace and inverter phase not locked
Para. Cable Abnormal	Parallel cables are not well connected or the cables are damaged
LBS Cable Abnormal	LBS cables are not well connected or the cables are damaged
Loss of Redundancy	Loss of redundant capacity
Pwr. Hardware Mismatch	The model information set at the host is inconsistent with the actual situation
Module Overtemp.	The power tubes of rectifier and inverter inside the module have overtemperature
Charger Overtemp.	The power tube of charger inside the module has overtemperature



### Note

1. For UPS installed with the optional battery monitor, refer to the user manual of the battery monitor for the alarm messages related to battery cell and charge current.
2. If the alarm is caused through setting the software value by Vertiv authorized engineer, and you wish to change the setting values, please contact the Vertiv local customer service center.

## Chapter 5 UPS Operation Introduction

This chapter introduces the operating precautions and routine operating methods of UPS single module in detail. For the operating precautions and routine operating methods of UPS parallel system, refer to Chapter 7 for details.

### 5.1 Brief Introduction

#### 5.1.1 Precautions



#### Important

The user can conduct relative operation only after the authorized engineer carries out the first power on and test.



#### Warning: hazardous mains and/or battery voltage

1. No operator-serviceable parts are located behind covers that require a tool for their removal. Only qualified service personnel are authorized to remove such covers.
2. The AC/DC input and output terminals of UPS have dangerous voltage at any time. If the cabinet is equipped with an EMC filter, the filter may have dangerous voltage.

1. For the operation keys and TOUCHSCREEN related to all the operating steps, refer to *Chapter 4 Operator Control And Display Panel*.
2. During operation, the buzzer alarm may occur at any time. Silence the audible alarm through the touchscreen.
3. When UPS uses traditional lead-acid battery, the system provides boost charge optional function. If the lead-acid battery is used, when the mains returns after an extended mains failure, the charging voltage of the battery will be higher than the normal charging voltage, this is normal, and the charging voltage of the battery will return to normal value after a few hours' charging.

#### 5.1.2 Power Switch

Opening the front door of the UPS cabinet reveals the power switches, as shown in Figure 5-1, including:

**Q1:** Rectifier input switch, which connects UPS to the main circuit power.

**Q2:** Bypass input switch, which connects UPS to the bypass.

**Q3:** Maintenance bypass switch (lockable), which supplies power to the load when UPS is being maintained.

**Note:** If the UPS system is composed of more than two paralleled UPS modules, do not use the internal maintenance bypass switch.

**Q5:** Output switch, which connects UPS output to the load.



#### Note

Q1, Q2, and Q5 are optional.

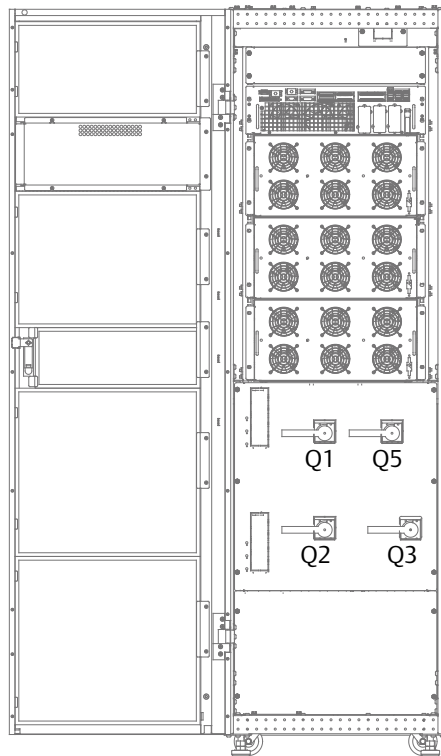

80kVA ~ 120kVA

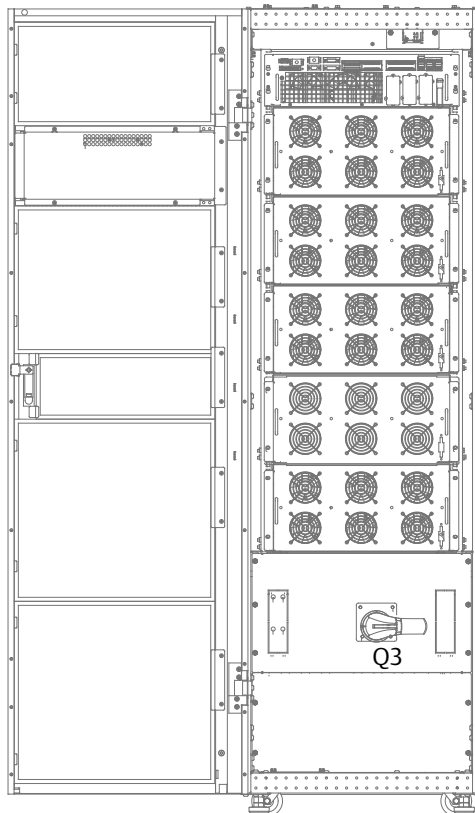

160kVA ~ 200kVA

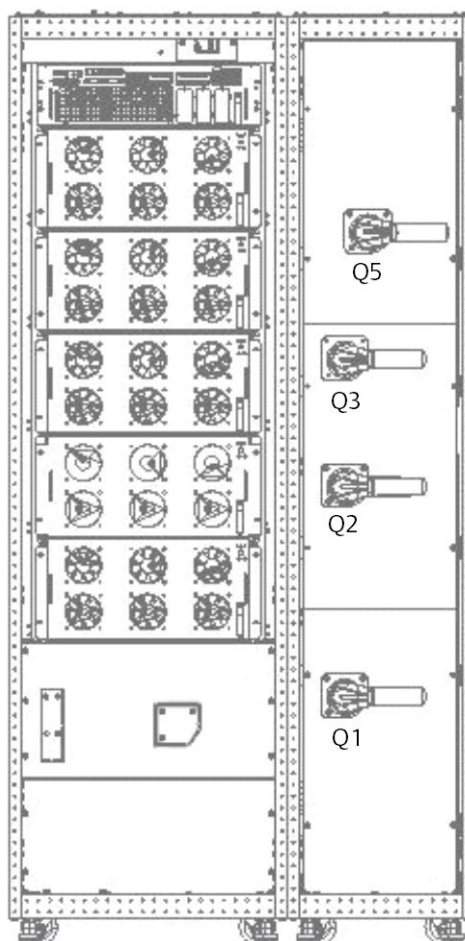

160kVA ~ 200kVA (with optional switch cabinet)

Figure 5-1 UPS power switch

## 5.2 UPS Startup Procedures

The UPS must be completely installed and tested by authorized engineer, and external power supply switch is closed, then you can start the UPS.

### 5.2.1 Startup Procedures In Normal Mode



Warning

1. These procedures result in mains voltage being applied to the UPS output terminals.
2. If any load equipment is connected to the UPS output terminals, check with the user that it is safe to apply power. If the load is not ready to receive power, please disconnect the downstream load switch, and stick a warning label on the connection point of the load.

Use the following procedures to turn on the UPS from a fully powered down condition.

1. Open the front door of the UPS, ensure that the internal maintenance bypass switch Q3 is disconnected, while the input cables and copper bars are reliably connected.
2. Close the external input switch, ensure that the UPS input voltage, frequency and phase are normal.



Warning

To avoid misreporting as faults, all operations relating to disconnection or connection of the maintenance bypass switch shall be finished within three seconds.

3. Close the output switch Q5, bypass input switch Q2, rectifier input switch Q1, and all external output isolating switches (if any) of the UPS in turn.

At the moment, the system is powered on, and the startup screen pops up.

About 25 seconds later, click the icon  to enter the system by inputting correct password.

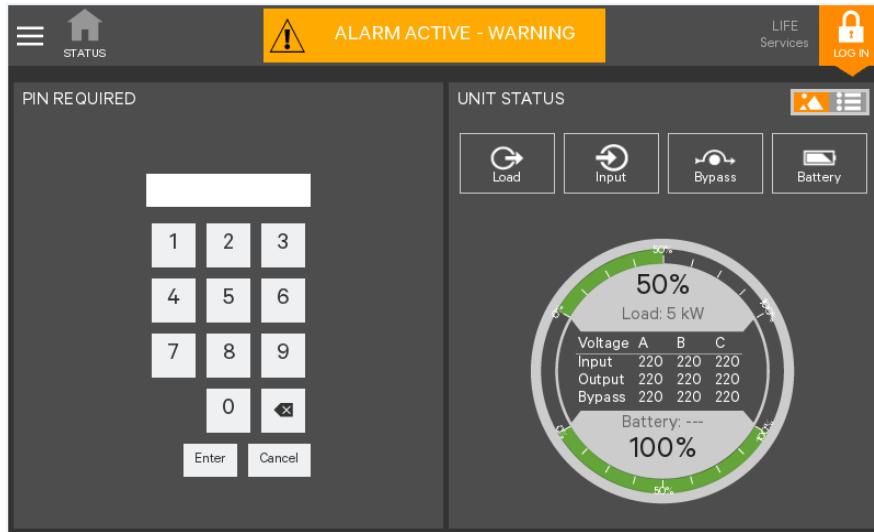

Figure 5-2 Inputting password

4. When the rectifier start process is finished, close the battery circuit breaker, and the system will run in Bypass mode (Power flow shown in Figure 5-3). Click the **On** key (Refer to Section 4.3.3).

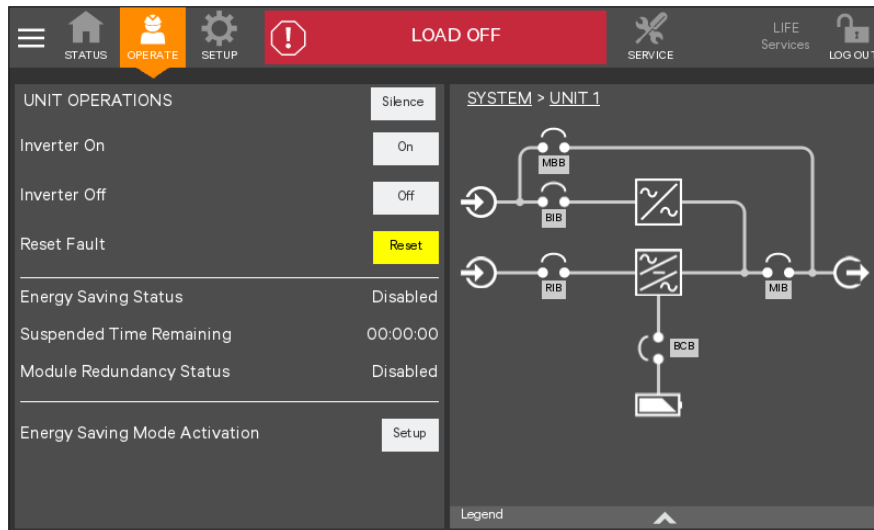

Figure 5-3 Clicking On key



5. The inverter starts self-test and sync.

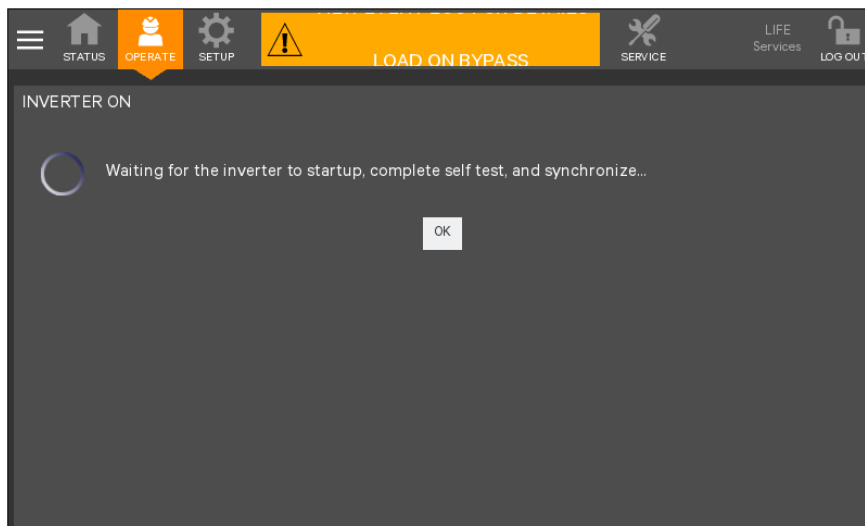

Figure 5-4 Inverter self-test and sync

6. Start-up is finished.

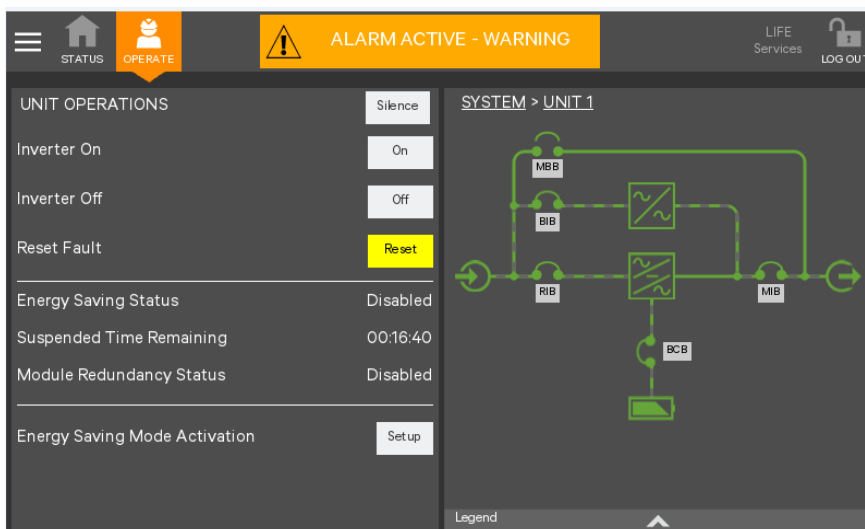



Figure 5-5 Start-up finished

## 5.2.2 Startup Procedures In ECO Mode

1. Open the front door of the UPS, ensure that the internal maintenance bypass switch Q3 is disconnected, while the input cables and copper bars are reliably connected.

 	<b>Warning</b>
<p>To avoid misreporting as faults, all operations relating to disconnection or connection of the maintenance bypass switch shall be finished within three seconds.</p>	

2. Close the output switch Q5, bypass input switch Q2, rectifier input switch Q1, and all external output isolating switches (if any) of the UPS in turn.

At the moment, the system is powered on, and the startup screen pops up.

3. If ECO mode is required, contact Vertiv service engineer to set it through the setting software. If you wish to set it by yourself, you can enable it through the sub-menu under 'SETUP' on the TOUCHSCREEN screen. For details, refer to Section 4.3.3.

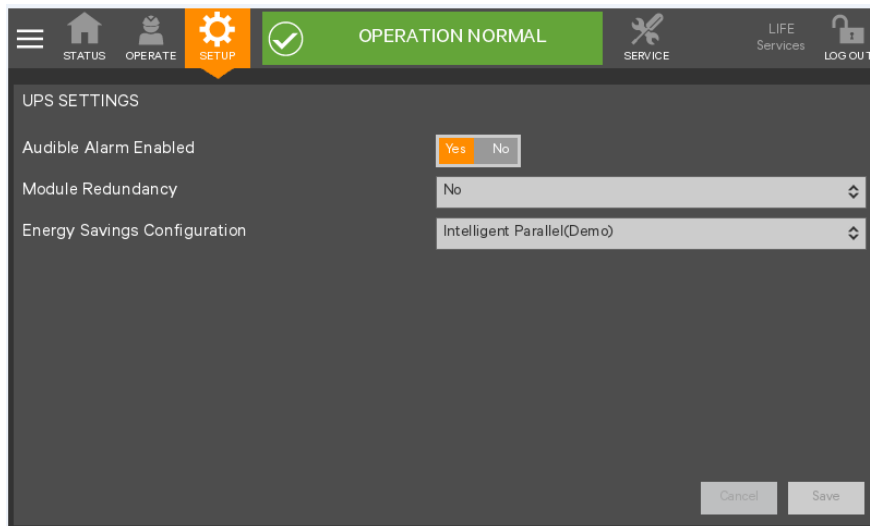

Figure 5-6 Setting ECO mode

4. When the rectifier start process is finished, start the system according to Section 5.2.1. After the inverter runs normally, if the bypass voltage is within the range of ECO power supply, then the system works in ECO mode; otherwise the system will transfer to inverter. The system will automatically work in ECO mode after the bypass voltage is within the range of ECO power supply and lasts for five minutes.

*UPS operated in ECO mode*

### 5.2.3 Startup Procedures In Battery Mode (Battery Cold Start)

1. Verify that the battery has been connected, and that the battery voltage is transferred to the input terminal of the battery.
2. Open the front door, and press the battery cold start button (see Figure 5-7 for its position) of any module.
3. When the rectifier start process is finished, and the system is on Bypass (power flow shown in the Figure below). Start the system according to steps 4-6 in Section 5.2.1.

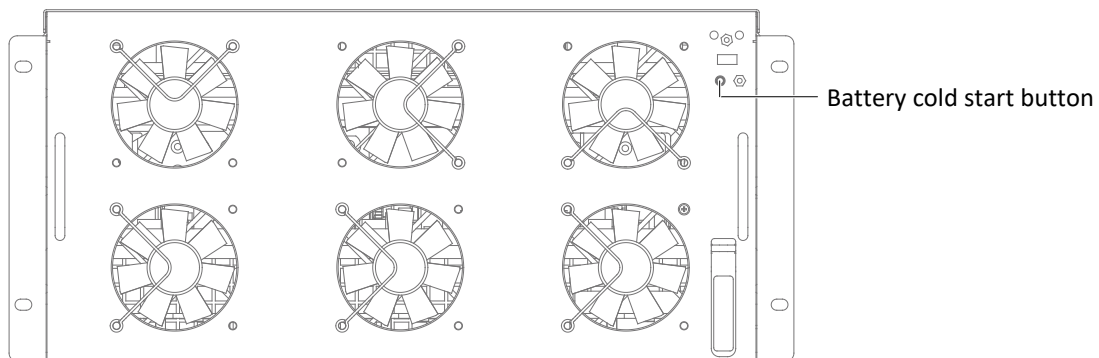

Figure 5-7 Battery cold start button

## 5.3 Procedures For Transfer Between Operation Modes

### 5.3.1 Transfer From Normal Mode To Battery Mode

Open the external power switch to isolate the mains power and initiate the UPS on battery mode. To transfer the UPS back to normal mode, then close the external power switch to re-connect the mains power to the UPS. 10 seconds later, the rectifier restarts automatically, and the UPS works in normal mode.

### 5.3.2 Transfer From Normal Mode To Bypass Mode

Click the **Off** key shown in Figure 5-8, and the UPS will transfer to bypass mode.

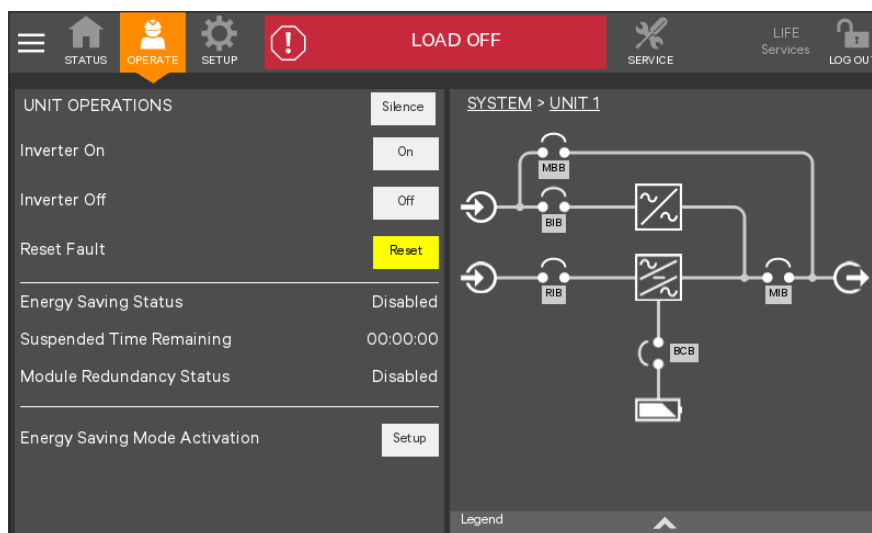

Figure 5-8 Transfer UPS to Bypass mode

**Note**

In bypass mode, the load is directly fed by the mains power instead of the pure AC power from the inverter.

### 5.3.3 Transfer From Bypass Mode To Normal Mode

When the UPS is in bypass mode, click the **On** key in Figure 5-9, and the inverter starts up. Then the UPS is transferred from bypass mode to normal mode.

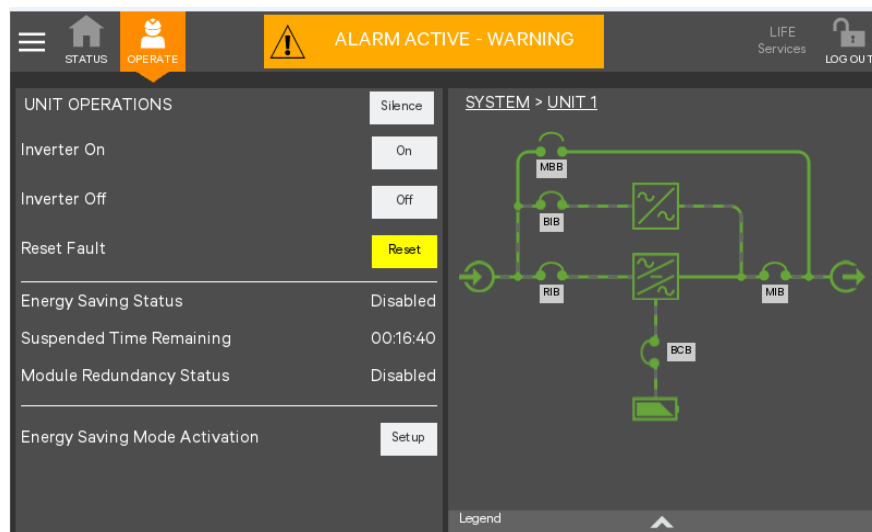

Figure 5-9 Transfer UPS to Normal mode

### 5.3.4 Transfer From Normal Mode To Maintenance Mode

The following procedures will transfer the UPS from inverter output mode to the maintenance bypass mode.

**Caution: power supply interruption danger of the load**

Before making this operation, read the information on the TOUCHSCREEN to make sure that the bypass supply is normal and that the inverter is synchronous with the bypass supply, so as not to risk a short interruption in power to the load.

1. Shut down the inverter according to Section 5.3.2.

**Note**

The alarm can be silenced but leaves the alarm message displayed until the alarm condition is rectified.

2. Close the maintenance bypass switch Q3.
3. At the moment, the maintenance bypass parallels with the UPS static bypass.
4. The TOUCHSCREEN displays 'Maint. Switch Closed'.



#### Caution

When the UPS is in maintenance mode, the load is not protected against abnormal mains supply.

5. Pressing the EPO button stops the operation of rectifier, inverter, static switch and battery, but this action will not affect the maintenance bypass power the load normally.



#### Note

Under maintenance mode, the load is directly fed by the mains power instead of the pure AC power from the inverter.

6. Disconnect the rectifier input switch Q1, bypass input switch Q2, and output switch Q5.

At the moment, all the internal power supply is off and the TOUCHSCREEN does not display any more.



#### Warning

1. If the maintenance is required, wait 10 minutes for the internal DC bus capacitance discharging.
2. The parts of UPS circuits also have hazardous voltage, though the rectifier input switch, bypass input switch and battery switch are disconnected. Therefore, the UPS maintenance is applicable to qualified personnel only.

### 5.3.5 Transfer From Maintenance Mode To Normal Mode

The following procedures will transfer the maintenance bypass supply mode of the UPS to the normal mode.

1. Close the output switch Q5, external power bypass switch, bypass input switch Q2, external power main switch and rectifier input switch Q1 in turn.

Confirm that the TOUCHSCREEN is on and the UPS runs in Bypass mode.

2. Disconnect the maintenance bypass switch Q3.
3. Start the system according to steps 4~6 in Section 5.2.1.

Now the UPS runs in Normal mode.



#### Warning

You must start the bypass first, and then disconnect the maintenance bypass switch; or it may cause output load power failure.

*At the moment, the load has transferred to UPS normal mode.*

## 5.4 Battery Test Procedures

The battery test function is disabled by default. If you need this function, please contact the customer service engineer of Vertiv.

The battery self-test includes periodical self-test and manual maintenance self-test. The battery discharge outputs 20% energy of the total battery energy.

Periodical self-test is to test the battery activity. The periodical self-test is regular, and the self-test period can be configured via the Vertiv setting software. During the periodical self-test, if the battery maintenance requirement is met, the system will generate audible/visual alarm and corresponding records. The periodical self-test does not update the battery curve table.

The mode of the manual maintenance self-test is similar to that of the periodical self-test, except for the maintenance self-test mode is started manually, and this operation is valid only one time, that is the system will not be automatically start up the self-test once you exit. During the maintenance self-test, if the battery maintenance requirement is satisfied, the

system will generate audible/visual alarm and corresponding records. The maintenance self-test does not update the battery curve table.

**Note:** The periodical self-test should satisfy the conditions of battery float charge at least 5h, and generator not connected, while the manual maintenance self-test just satisfies the conditions of battery fully charged.

### Achievement

1. Manual maintenance self-test: via the TOUCHSCREEN.
2. Periodical self-test: self-test period can be configured via the Vertiv setting software. The range of battery self-test period is 30 days ~ 360 days (default: 60 days).

### Self-test startup conditions



1. System load rate is within 20% ~ 100%, stable output.
2. Battery in fully charged state, battery float charge at least 5h, and generator not connected
3. Current system is in float charge state

### Self-test exit conditions

1. Confirm that the system is not in self-test state at least 10 seconds, and satisfies the following conditions: in battery mode or rectifier is closed, and then the system will shift to battery supply state.
2. During the self-test, the system will shift to float charge state if the load fluctuation, UPS module overload or no battery occurs.
3. During the self-test, if the battery voltage is lower than the calculated pre-alarm voltage, or the battery discharge exceeds the protection time, then the system will shift to float charge state.
4. The user can manually stop the maintenance test via the TOUCHSCREEN.

**Note:** After the self-test is successful, the system will fully clear the self-test interval counter. If the self-test fails this time, then exits the system; when self-test conditions are satisfied again, enters self-test once more.

### Procedures for battery self-test

1. Enter the level of **OPERATE**.
2. Click the icon .
3. Click the menu icon  on the upper left corner.
4. Click the 'Battery Operations' to display the interface shown in Figure 5-10.
5. Respectively click 'Automatic Battery Test', 'Manual Battery Test', 'Calibrated Battery Test' and 'Battery Equalize', then you can execute corresponding settings and operation.

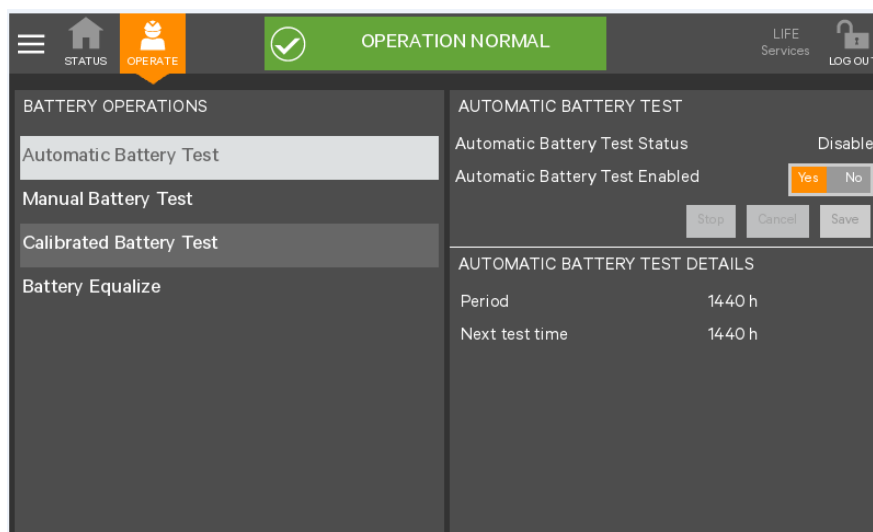

Figure 5-10 Battery management interface

## 5.5 UPS Shutdown Procedures

### 5.5.1 Procedures For Completely Powering Down UPS

Complete UPS shutdown and load power-off should follow this procedure. All power switches, isolating switches and breakers are disconnected, and then UPS no longer supplies power to load.



#### Caution

The following procedures will cut off the load power, making the load completely power off.

1. Click the INVERTER OFF key to stop the operation of the inverter (Refer to Section 4.3.3). Then press the EPO button to stop the operation of the rectifier, static switch and battery.
2. Disconnect the switch of the external battery.
3. Disconnect the rectifier input switch Q1, bypass input switch Q2, output switch Q5. At the moment, all the internal power supply is off and the TOUCHSCREEN does not display any more.



#### Warning

1. Post a label at the AC input distribution (generally far away from the UPS) to alert that the UPS maintenance is being operated.
2. Wait 10 minutes for the internal DC bus capacitance discharging. Then the UPS is completely shut down.



#### Warning: hazardous battery voltage

The battery terminals still have hazardous voltage after the UPS is completely shut down.

### 5.5.2 Procedures For Completely Powering Down UPS While Maintaining Power To Load

The following procedures are suitable for completely powering down the UPS and still keeping the power supply to the load. Refer to the procedures in 5.3.4 *Transfer From Normal Mode To Maintenance Mode*.

## 5.6 EPO Procedures

The EPO is designed to switch off the UPS in emergency conditions (that is, fire, flood, etc.). To carry out EPO, you just need to press the EPO button, then the system will turn off the rectifier, inverter and stop powering the load immediately (including the inverter and bypass), and the battery stops charging or discharging.

After EPO, if the input mains is present, the UPS's control circuit will remain active; however, the output will be turned off. To remove all power from the UPS, first disconnect the external power switch of the UPS.

## 5.7 UPS Reset Procedures After EPO

After shutting down the UPS through EPO or reasons of inverter overtemperature, overload, battery overvoltage and DC bus voltage, clear the fault according to the alarm message displaying on TOUCHSCREEN screen. Then carry out the following reset procedures to make UPS resume normal operation.

After confirming the fault has been cleared and no remote EPO signal is received, the user can carry out the following procedures:



1. Click the Reset FAULT button (Refer to Section 4.3.3), the system will exit the EPO/abnormal OFF state, and the alarm indicator flashes in red color.
2. After the rectifier start-up is finished, normally start the UPS according to Section 5.3.2.



#### Note

The rectifier will start automatically when the overtemperature fault disappears five minutes after the disappearance of overtemperature signal.

3. After pressing the EPO button, if the mains input is switched off, the UPS will shut down completely. When the mains input returns, the UPS will start up on bypass. There will be power at the output terminals of the UPS.

  <b>Warning</b>
If the maintenance bypass switch Q3 is closed and the UPS has input power, it means UPS has outputs.

## 5.8 Automatic Restart

In the case of a mains failure, the UPS draws power from the battery system to supply the load until the batteries are depleted. When the UPS reaches its EOD threshold, it will shut down.



The UPS will automatically restart and enable output power only when the following conditions are met:

1. If Auto Recovery after EOD Enabling is enabled.
2. After the Auto Recovery after EOD Delay Time expires (the default delay is 10 minutes), the UPS restarts bypass, then inverter. During the automatic recovery delay, the UPS will charge its batteries to provide a safety margin for equipment shutdown if input power fails again.

 <b>Note</b>
During the automatic restart process, manual startup is disabled. Automatic restart must be set by Vertiv's authorized service engineer through Vertiv setting software.

## 5.9 Selecting Language

Use the following procedures to select the language:

1. Click the icon .
2. Click the icon .
3. Click the item of Display.
4. Click 'Display Properties'.
5. As shown in Figure 5-11, click 'Language' to set the language you need.

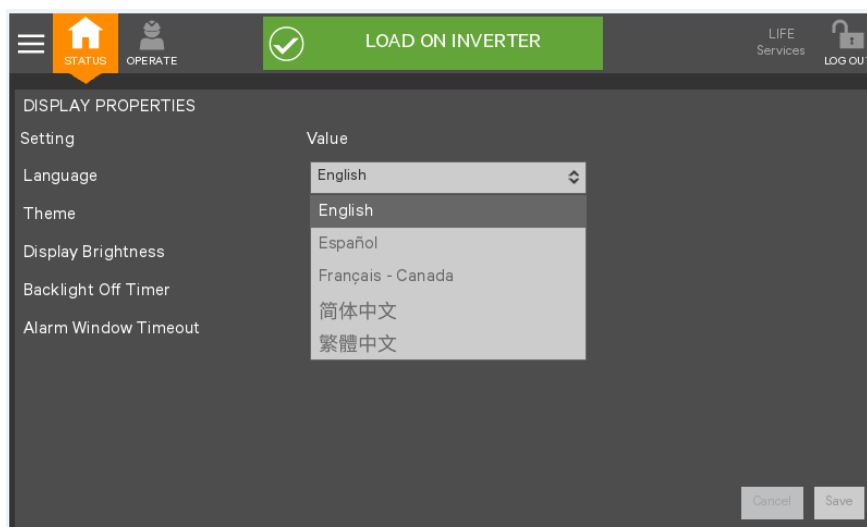



Figure 5-11 Setting language

## 5.10 Changing Current Date And Time

Use the following procedures to change the system date and time:

1. Click the icon .
2. Click the icon .
3. Click the item of Display.
4. Click 'Date&Time'.
5. Refer to Figure 5-12, set the actual date and time.

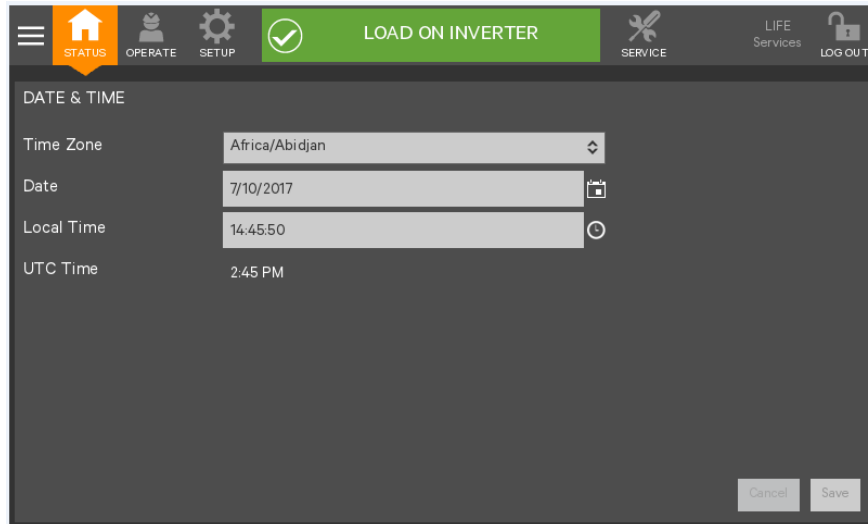



Figure 5-12 Setting date and time

## 5.11 Control Password

To change password, carry out the following procedures:

1. Enter SETUP level.
2. Click the icon .
3. Refer to Figure 5-13, set password changing.

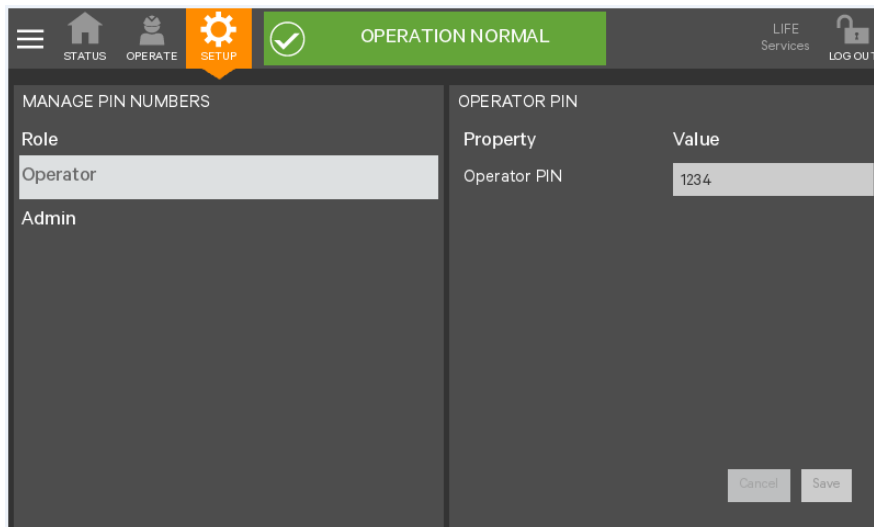

Figure 5-13 Setting password



## Chapter 6 Battery

This chapter introduces the battery, including the battery safety, installation and maintenance information, battery protection function, as well as the connection of BCB box (option), battery temperature sensor (option), and battery ground fault detector (option).

### 6.1 Introduction

The UPS battery string is composed of several batteries in series connection and provides rated DC input voltage for the UPS inverter. The required battery backup time (i.e. the time for battery to supply load upon mains failure) is subject to the ampere-hour value of the battery. Sometimes, it is necessary to connect several strings of battery in parallel.

To facilitate the UPS installation, the battery is generally installed on the specially designed battery rack or in the battery room.

During the maintenance or repair, the battery must be disconnected from the UPS. This operation may be realized by the battery circuit breaker of proper capacity. This circuit breaker shall be located as close as possible to the battery connecting terminal, and the wiring distance of the power and signal cables connected to the UPS shall be minimized.

When several strings of battery are paralleled to increase the battery backup time, disconnecting device shall be equipped, so that the maintenance operation on a certain battery string will not affect the normal operation of other battery strings.

### 6.2 Safety



Take special care when working with the batteries associated with the UPS. When all the blocks are connected together, the battery string voltage can be up to 540Vdc. This is potentially lethal. Please follow the precautions for high voltage operation. Only qualified personnel are allowed to install and maintain the battery. To ensure safety, the external batteries are to be installed inside a lockable cabinet or in a purpose-designed, dedicated battery room, so that they are only accessible to qualified service personnel.

Confirm that the battery switch has been disconnected before battery maintenance.



**Warning: hazardous battery voltage present behind covers**

1. No user-serviceable parts are located behind covers that require a tool for their removal. Only qualified service personnel are authorized to remove such covers.
2. Before working on the copper bars connected to the external battery, please ensure they are disconnected from all power supplies.

Proper connection mode	Improper connection mode	
Tighten the terminal bolt of the battery with specified torque	Too large or too small torque may cause poor connection of the terminal. Under certain conditions, the terminal may have arcing or heat accumulation, which finally will cause fire	
		



3. Observe the following safety precautions when working on the batteries:
  - a) The battery shall be firmly and reliably connected. After the connection is completed, the screw connections between all the



**Warning: hazardous battery voltage present behind covers**

terminals and the batteries shall be calibrated. The requirements on torque specified in the specifications or user manual provided by the battery manufacturer shall be satisfied. The connections between all the wiring terminals and the batteries shall be inspected and tightened at least once a year. Otherwise it may cause fire!

b) The battery appearance must be inspected before accepting and using the battery. If there exists any package damage, dirty battery terminal, terminal erosion, rust, or enclosure crack, deformation or liquid leakage, replace it with a new battery. Otherwise, battery capacity reduction, electric leakage or fire may be caused.

Battery damaged during handling or transportation	After a week of normal charge/discharge experiment
	

c) The battery is very heavy. Please use proper method to move and lift the battery, so as to prevent any damage to human being or the battery terminal. Severe damage to the battery may cause fire.

d) The battery connecting terminal shall not be subject to any force, such as the pulling force or twisting force of the cable, otherwise, the internal connection of the battery may be damaged. Severe damage to the battery may cause fire.

e) The battery shall be installed and stored in a clean, cool and dry environment. Do not install the battery in a sealed battery chamber or a sealed room. The battery room ventilation shall at least meet the requirement of EN50272-2001. Otherwise, battery bulging, fire or even human injury may be caused.

f) The battery shall be installed far away from the heating products (e.g. transformer), used or stored far away from any fire source, and shall not be burnt or put into fire for heating. Otherwise, battery leakage, bulging, fire or explosion may be caused.

g) Do not directly connect any conductor between the positive and negative terminals of the battery. Remove the finger rings, watch, necklace, bracelet and other meta items before operating the battery, and ensure that the tools (e.g., wrench) are covered with insulating material. Otherwise, battery burning, human death/injury or explosion may be caused.

h) Do not disassemble, modify or demolish the battery. Otherwise, battery short circuit, liquid leakage or even human injury may be caused.

i) Clean the battery enclosure with the wringed wet cloth. To avoid any static or arcing, do not use dry cloth or duster to clean the battery. Do not use the organic solvent (such as thinner, gasoline, volatile oil) to clean the battery. Otherwise, the battery enclosure may be cracked. In worst case, fire may be caused.

j) The battery has diluted sulfuric acid. In normal use, the diluted sulfuric acid will be absorbed to the baffle and polar plate of the battery. However, if the battery is damaged, the acid may leak from the battery. Therefore, personal protective equipment (e.g., protective glasses, rubber gloves and apron) must be used when operating the battery. Otherwise, if the diluted sulfuric acid enters the eyes, blindness may be caused; if it contacts the skin, the skin may be burnt.

k) The battery may have short circuit, electrolyte dry-up or positive pole erosion failure at the end of its life. If it is still used under this state, the battery may have thermorunaway, bulging or liquid leakage. Please replace the battery before it becomes this state.

l) Before connecting or disconnecting the battery connection cables, please isolate the charging power.

m) Check if the battery has been unexpectedly earthed. If this is the case, remove the earth connection. Contact with any part of the earthed battery may result in an electric shock.

### 6.3 UPS Battery

The UPS generally adopts valve-regulated battery. At present, 'valve-regulated' means the 'sealed type' or 'maintenance free' mentioned in the past.

The valve-regulated battery is not completely sealed, especially when it is over-charged, there will be gas escape. The volume of the gas escape is less than the water injection battery. However, during the installation design of the battery, temperature rise shall be taken into account, and enough room shall be reserved to ensure good ventilation.

Besides, the valve-regulated battery is not maintenance free. The valve-regulated battery must be kept clean, and it shall be inspected regularly to check if the connection is reliable, and if it is corroded. For details, please refer to 6.14 *Battery Maintenance*

It is suggested to connect no more than 4 strings of batteries in parallel. Batteries of different types, names or newness shall not be used together. Otherwise, the battery inconsistency will cause frequent over-discharge or under-charge of certain battery. At last, the battery will have premature failure, and the entire string of battery will have insufficient backup time.

The battery must be stored in fully charged state. The battery will lose certain capacity because of self discharge during the transportation or storage. Charge the battery before use. During the storage, ensure that the ambient temperature shall not exceed the range of -15°C ~ +45°C, and the optimal temperature is 20°C ~ 25°C. To compensate for the self discharge of the battery during the storage, the battery shall be charged every 3 months during the storage. The specific time may differ for different batteries. For details, refer to the requirement of the battery manufacturer.

It is very important to fully charge the battery before carrying out onsite test on the battery backup time. The test may take several days. Therefore, it should be conducted after the battery has been subject to uninterrupted float charging for at least one week.

When the battery has been running for several weeks or subject to two to three charge and discharge cycles, the battery performance will be increased.

To avoid the battery over-charge or under-charge, please set the battery management parameters according to the equalizing/float charge voltage and temperature compensation factor specified in the manuals provided by the battery manufacturer. Please charge the battery immediately after discharge.

## 6.4 Precautions For Installation Design



### Note

Precautions for installation, use and maintenance of the battery are described in the relevant battery manual provided by the battery manufacturer. The safety precautions described in this section include the important matters that must be considered during the installation design. The design results may be changed according to the local situations.

## 6.5 Battery Installation Environment And Number Of Batteries

### 6.5.1 Installation Environment

#### Fresh air volume (EN50272-2001)

The operating environment of the battery must be ventilated. During the operation of the battery, the following requirement for the fresh air ventilation shall be satisfied:

$$Q=0.05 \times n \times I_{\text{gas}} \times C_{\text{rt}} \times 10^{-3}[\text{m}^3/\text{h}]$$

Where:

Q—The fresh air ventilation volume per hour, the unit is m<sup>3</sup>/h

n—Number of cells

$I_{\text{gas}}$ —The gas evolving current density under battery float charging or boost charge conditions, the unit is mA/Ah

$I_{\text{gas}}=1$ , under the float charging condition of 2.27V/cell

$I_{\text{gas}}=8$ , under the boost charge condition of 2.35V/cell

$C_{\text{rt}}$ —20hr battery rated capacity

## Temperature

Table 6-1 Range of ambient temperature

Type	Temperature value	Remark
Recommended optimal temperature	20°C ~ 25°C	The ambient temperature for the battery operation shall not be too high or too low. If the average operating temperature of the battery rises from 25°C to 35°C, the service life of the battery will be reduced by 50%. If the operating temperature of the battery is over 40°C, the service life of the battery will be reduced exponentially each day
Short time allowable temperature	-15°C ~ 45°C	

The higher the temperature is, the shorter the battery service life will be. At low temperature, the charge/discharge performance of the battery will be significantly reduced.

The battery must be installed in cool and dry environment with the humidity less than 90%, and be protected from the heat source and direct sunshine.

The ambient temperature, ventilation, space, float/boost charge voltage and ripple current will affect the battery temperature. Uneven temperature among the battery strings will cause uneven voltage distribution and thus result in problem. Therefore, it is very important to maintain balanced temperature in the battery string, and the temperature difference between batteries of different layers shall be kept within 3°C. Valve-regulated battery is very sensitive to the temperature, therefore the valve-regulated battery shall be used in 15°C ~ 25°C. If the battery cabinet is installed near the UPS, the maximum design ambient temperature shall be determined according to the battery rather than the UPS. That is, if valve-regulated battery is used, the indoor ambient temperature shall be 15°C ~ 25°C rather than the operating temperature range of the main equipment. Under the precondition that the average temperature will not exceed 25°C, it is allowed to have short time temperature deviation.

### 6.5.2 Number Of Batteries

The system battery cell number is 30 by default, and the cell float voltage is 2.27V. The number of batteries, EOD voltage, and float charging voltage under the 380V/400V/415V voltage system are consistent, as shown in Table 6-2.

Table 6-2 Number of batteries

Parameter	380V/400V/415V
Number of cells (standard)	180 ~ 264
EOD voltage	1.60Vdc/Cell ~ 1.90Vdc/Cell, 1.63V/cell recommended
Float charging voltage	2.2Vdc/Cell ~ 2.3Vdc/Cell, 2.27V/cell recommended

## 6.6 Battery Protection

Over current protection for the battery circuit must be provided by the customer when using external batteries or a battery cabinet installation not supplied with the EXM UPS.

The protective device should be fitted as close as possible to the battery and must be capable of protecting the battery against short-circuits, and should take into account the maximum current drain (in discharge at 1.8V per cell), see Table 6-4 for detailed recommendation.

The short circuit current rating for an entire battery string or system should be calculated by an engineer or a qualified person based on how the battery system is designed at the particular facility, and battery manufacturer shall be consulted for battery short circuit current values.

It is recommended to use the Battery Circuit Breaker (BCB) which includes additional hardware and controls to interface with the UPS which provides additional features to control the closure of the breaker and disconnect the batteries automatically.

This ensures the batteries cannot be connected on power-up if the start-up procedure is not followed and provides the addition controls to isolate automatically for the following conditions.

- End of battery discharge voltage (EOD)

- Emergency Power Off activated (EPO)
- UPS fault condition

## 6.7 Battery Installation And Connection

### 6.7.1 Battery Installation

1. Before installation, check the battery appearance to ensure that there is no damage, inspect and count the accessories, and carefully read this manual and the user manual or installation instruction provided by the battery manufacturer.
2. There shall be at least 10mm gap between the batteries in vertical direction, to ensure the free circulation of the ambient air of the batteries.
3. Certain clearance shall be maintained between the battery top and the upper layer to facilitate the monitoring and maintenance of the battery.
4. The batteries shall be installed from the bottom layer to top layer, so as to avoid a too high gravity center. The battery shall be properly installed and protected from vibration or shock.

### 6.7.2 Battery Connection

1. All the battery cabinets or battery racks must be connected together and properly grounded.
2. When multiple batteries are used, they shall be connected in series and then in parallel. Before loading and power-up, it must be detected that the total voltage of the batteries is as specified. The negative and positive poles of the batteries must be connected to the negative and positive battery terminals of the UPS according to the labels on the battery and UPS. If the battery is reversely connected, explosion and fire may be caused, it may result in battery and UPS damage or even human injury.
3. When the battery cable connection is finished, install insulating shield for the terminals.
4. When connecting the cable between the battery terminal and the BCB, the BCB terminal shall be connected first.
5. The bending radius of the cable shall be larger than 10D, wherein D is the outer diameter of the cable.
6. When the battery cable is connected, it is prohibited to pull the battery cable or the cable terminal.
7. Do not cross the battery cables during the connection, and do not tie the battery cables together.
8. See Figure 6-1 for battery connection.

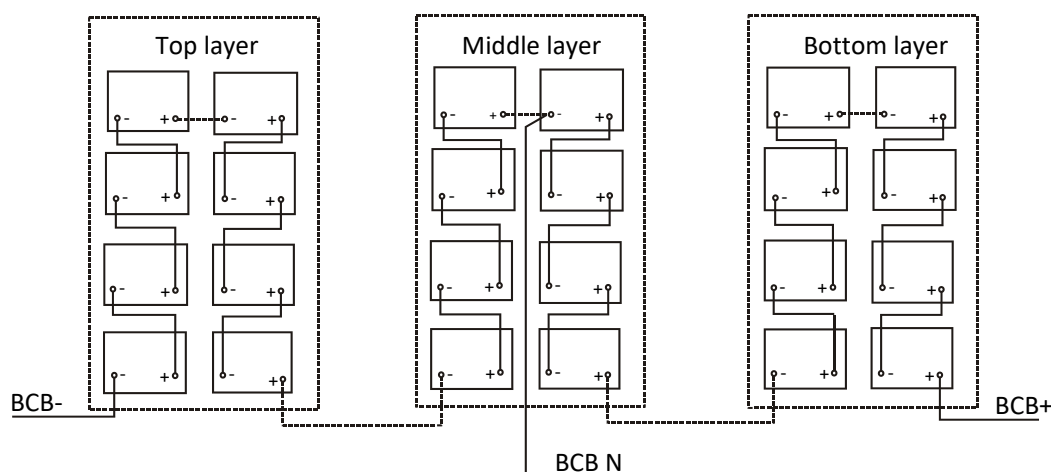

Figure 6-1 Connection of batteries

## 6.8 Design Of Battery Room

No matter which type of installation system is adopted, the following items shall be paid special attention to (refer to Figure 6-2):

**1** Layout of cells

No matter which battery installation system is used, the battery shall be located in a matter that it will not contact two naked live parts with the potential difference over 150V at the same time. If it is unavoidable, insulated terminal shield and insulated cable shall be used for the connection.

**2** Workbench

The workbench (or pedal) must be skid-proof and insulated, and at least 1m wide.

**3** Wiring

All the wiring distances shall be minimized.

**4** BCB

The BCB is generally installed in the wall-mounted box near the battery.

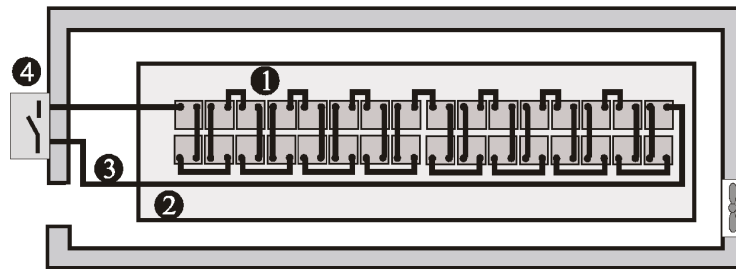

Figure 6-2 Design of battery room

## 6.9 Common Battery String

The UPS supports common battery string function, which indicates that each unit in the parallel system shares the same battery string to achieve the purpose of energy saving, space saving and efficiency improving. The cables connection for common battery string is shown in Figure 6-3. Note the following points when applying the common battery string:

1. All the units in parallel system share the same battery string, and no intermixing of common battery string with independent battery.
2. Each unit should use the common battery string.
3. Each UPS has its own BCB box.

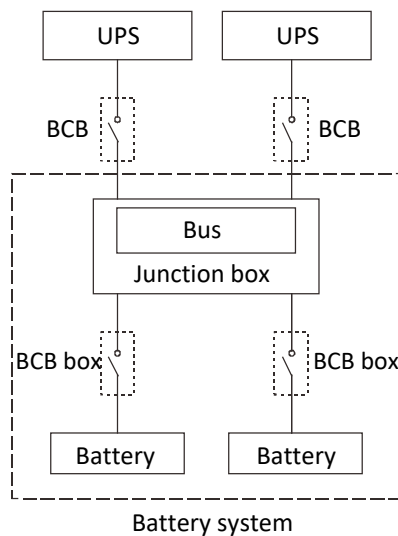

Figure 6-3 Connection of common battery string

## 6.10 BCB Box (Option)



### Warning

Isolating the battery is necessary for a safe maintenance and service, no matter whether you use Vertiv BCB box or not.

The UPS requires an optional BCB box, which contains one BCB and one BCB control board, to provide over-discharge and overcurrent protections for the battery. The BCB box can also electrically isolate the UPS from the battery to minimize the danger of the service personnel at work.

The BCB provides the following functions:

- Short circuit protection and EOD protection. The BCB opens automatically when the battery voltage drops to the EOD voltage point
- Support the UPS EPO function. The BCB opens automatically when the EPO switch on the operator control and display panel of the UPS is pressed
- When the UPS has internal fault, the BCB can be automatically tripped to protect against fault expansion, and then effectively protect the user's property safety

Table 6-3 provides the mechanical specifications of the BCB box.

Table 6-3 Parameters of BCB box

Dimensions (H × W × D) (mm)	Weight (kg)
650 × 1000 × 285	64

The BCB box should be installed as close as possible to the battery. It can be installed on a wall or a horizontal surface through the installation holes shown in Figure 6-4.

Refer to Figure 6-4 ~ Figure 6-6 to install and connect the BCB box. There are connection terminals in the BCB box for connecting the power cables from the UPS and battery. For signal cable connection, connect the accessory cable W812 shown in Figure 6-6.



### Note

1. The BCB box can use top cable entry and bottom cable entry. It provides two big and one small cable entry holes on both the top plate and bottom plate. The big ones are for power cable entry, and the small one is for signal cable entry. After connection, take appropriate measures to seal the cable entry holes.
2. The signal cable W812 must be run separate from the battery power cables. W812 is a shield cable, both ends of its shield layer must be connected to the enclosure. The UPS and BCB box must be earthed separately.
3. Make sure that the UPS rectifier has started before closing the BCB.

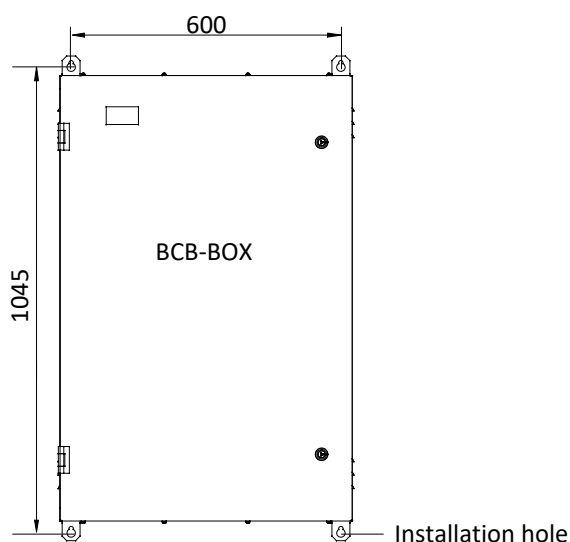

Figure 6-4 Installation hole dimension of BCB box (unit: mm)

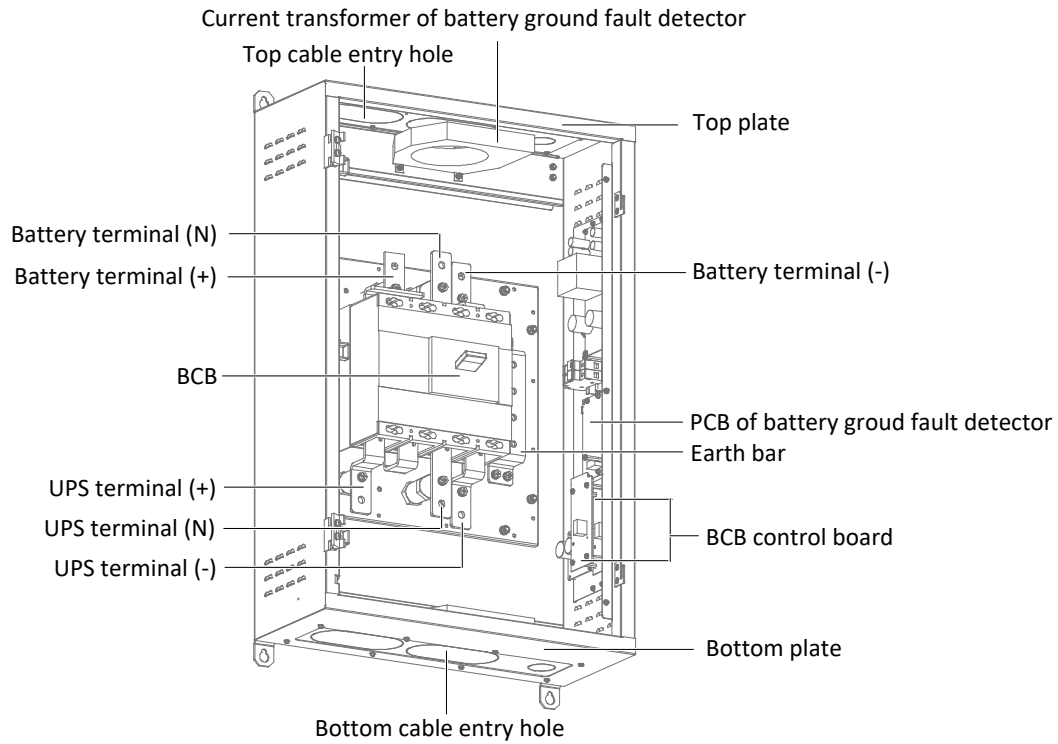

Figure 6-5 Internal structure of BCB box

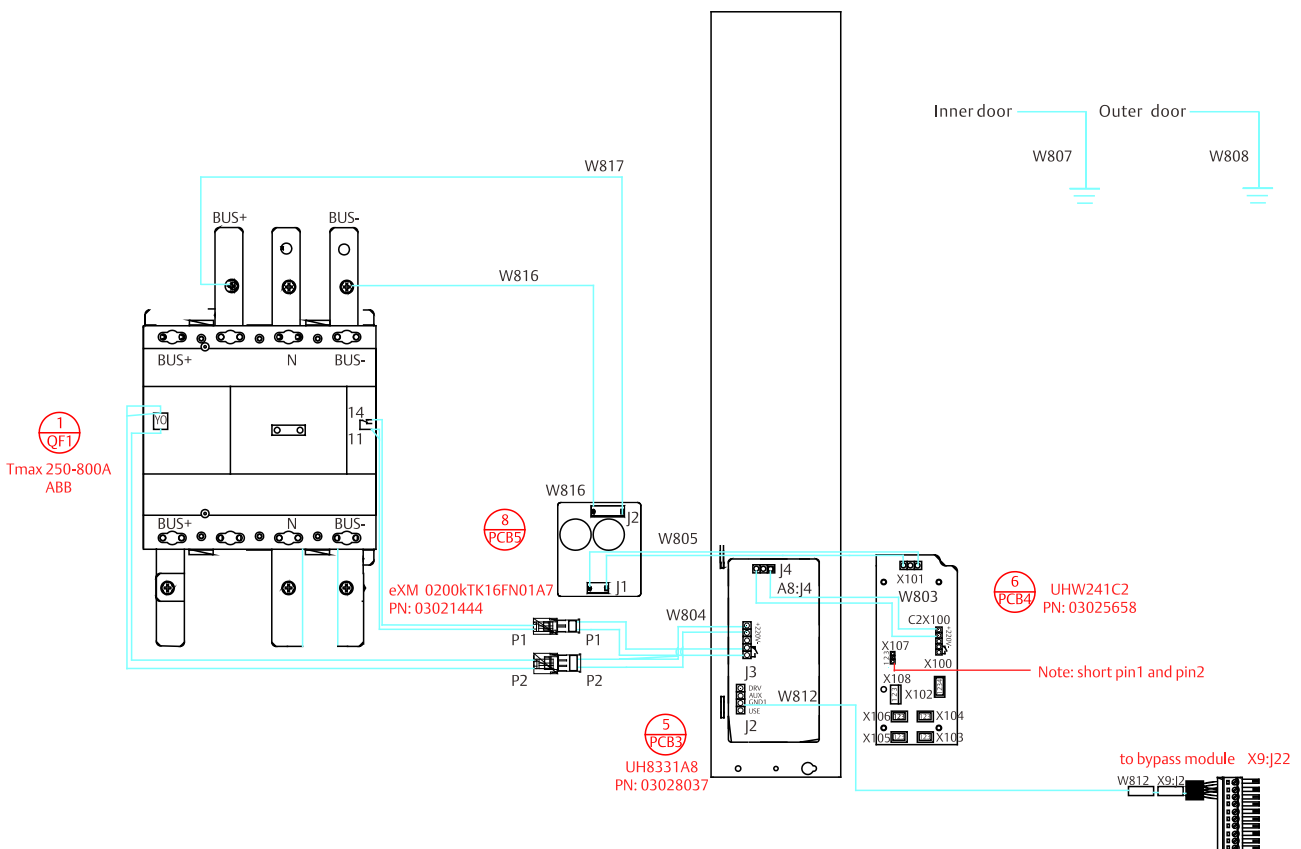

Figure 6-6 Connection diagram of BCB box



## 6.11 Battery Ground Fault Detector (Option)

Vertiv provides an optional battery ground fault detector. It includes a mutual inductor and a PCB, which should be installed in the BCB box. The installation position of the PCB is shown in Figure 6-5. If the BCB box uses top cable entry, the mutual inductor should be installed on the inside of the top plate of the BCB box, as shown in Figure 6-5; if the BCB box uses bottom cable entry, the mutual inductor should be installed on the inside of the bottom plate of the BCB box. Connect the PCB as shown in Figure 6-7.

**Note**

If a battery ground fault detector is installed, the positive, negative and neutral battery cables from the battery into the BCB box must be routed through the hole of the mutual inductor of the battery ground fault detector, while other cables must bypass the mutual inductor for connection.

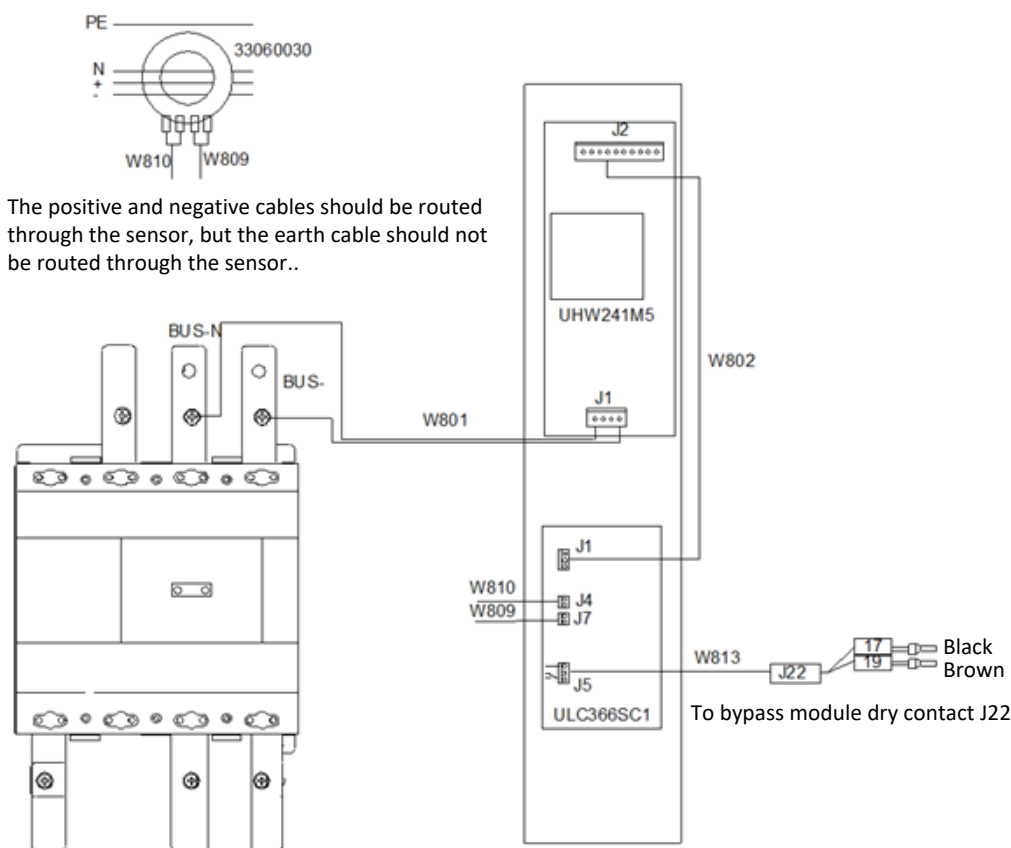

Figure 6-7 Wiring of battery ground fault detector

## 6.12 BCB Reference Current And Connection

Table 6-4 provides recommended BCB rated current and battery maximum discharge current at full load. Refer to Table 3B in IEC60950-1, and select appropriate cable CSA according to local electrical regulations.

Table 6-4 BCB rated current and battery max. discharge current at full load (recommended)

Items		Unit	UPS rated power (kVA)				
			80	100	120	160	200
30-block battery	Maximum battery discharge current at full load	A	296	369	443	591	739
	Reference rated current of BCB	A	400	400	630	800	800
	CSA of connection cable	mm <sup>2</sup>	120	120	150	240	240
32-block battery	Maximum battery discharge current at full load	A	277	346	416	554	693

Items	Unit	UPS rated power (kVA)					
		80	100	120	160	200	
Reference rated current of BCB	A	400	400	630	800	800	
CSA of connection cable	mm <sup>2</sup>	95	120	150	200	240	
34-block battery	Maximum battery discharge current at full load	A	261	326	391	521	652
	Reference rated current of BCB	A	400	400	630	630	800
	CSA of connection cable	mm <sup>2</sup>	95	120	150	185	240
36-block battery	Maximum battery discharge current at full load	A	246	308	369	493	616
	Reference rated current of BCB	A	400	400	630	630	800
	CSA of connection cable	mm <sup>2</sup>	95	120	120	185	240
38-block battery	Maximum battery discharge current at full load	A	233	292	350	467	583
	Reference rated current of BCB	A	400	400	400	630	800
	CSA of connection cable	mm <sup>2</sup>	70	120	120	185	200
40-block battery	Maximum battery discharge current at full load	A	222	277	332	443	554
	Reference rated current of BCB	A	400	400	400	630	800
	CSA of connection cable	mm <sup>2</sup>	70	95	120	150	200
42-block battery	Maximum battery discharge current at full load	A	211	264	317	422	528
	Reference rated current of BCB	A	400	400	400	630	630
	CSA of connection cable	mm <sup>2</sup>	70	95	120	150	185
44-block battery	Maximum battery discharge current at full load	A	201	252	302	403	504
	Reference rated current of BCB	A	400	400	400	630	630
	CSA of connection cable	mm <sup>2</sup>	70	95	120	150	185



**Note**

1. Current calculation is according to the DC/AC efficiency of 0.94 and EOD voltage of 1.6V/cell.
2. It is recommended to use a 4P DC MCCB, with DC rated voltage of the breaker meeting 1-pole 250Vdc, 2-pole 500Vdc, 3-pole 750Vdc, and rated breaking capacity limit being 35kA. Refer to Figure 6-8 for the connections between the battery, BCB and UPS.

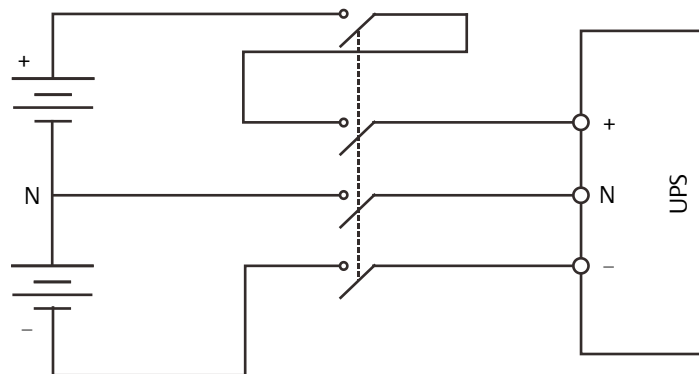

Figure 6-8 Connections between battery, BCB and UPS (3 wire at battery side, battery consisting of 30 to 44-block)

## 6.13 Battery Temperature Sensor (Option)

Vertiv provides an optional battery temperature sensor. Connect the battery temperature sensor as shown in Figure 6-9.

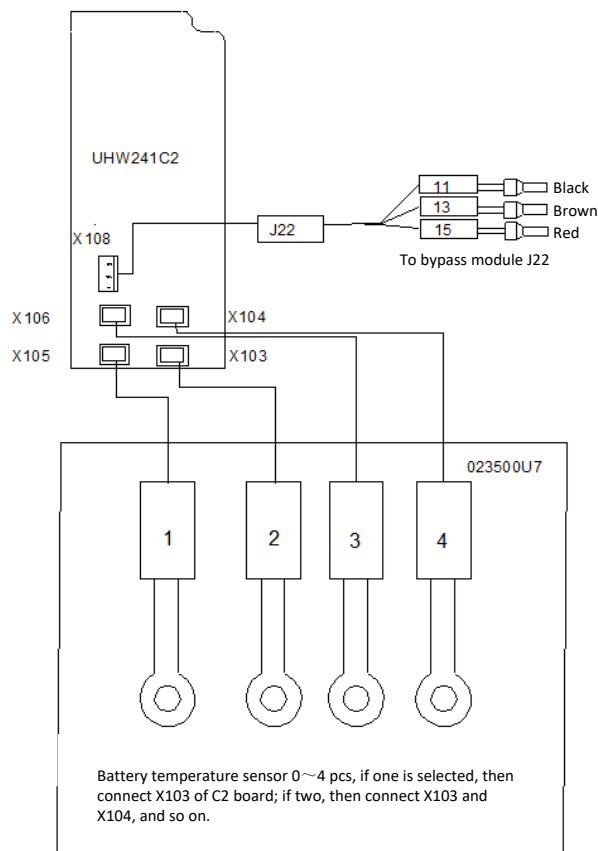

Figure 6-9 Wiring of battery temperature sensor

## 6.14 Battery Maintenance

For the battery maintenance and maintenance precautions, refer to IEEE-Std-1188-2005 and the relevant manuals provided by the battery manufacturer.



### Note

1. Periodically check the screws of the battery connection parts and confirm that they are firmly tightened. If there is any loosened screw, tighten it immediately.
2. Ensure that all safety devices operate normally, and that the battery management parameters are set properly.
3. Measure and record the air temperature inside the battery room.
4. Check to ensure that the battery terminals have no damage or heat generating trace, and the battery enclosure and terminal shields are intact.

## 6.15 Disposal Of Used Battery

If the battery has liquid leakage or is damaged, place the battery into the container that can withstand sulphuric acid and discard it according to the local regulations.

Used lead acid storage battery belongs to dangerous waste, and it is a key item for used battery pollution control. The storage, transportation, use and disposal of the battery shall comply with the national and local laws and regulations on dangerous waste and used battery pollution prevention and other standards.

According to the relevant national regulations, the used lead acid storage battery must be recycled and shall not be disposed of with other methods. Random discard or any other improper disposal of the used lead acid storage battery may cause severe environment pollution and the relevant person will be investigated of corresponding legal responsibilities.

## Chapter 7 Parallel System And LBS System

This chapter gives details on the installation of parallel system and LBS system.

### 7.1 General

The parallel system can comprise of up to four UPS modules of the same power rating and connected in parallel without the need for a centralized mains static bypass. Instead the bypass static switches of each UPS share the load when the system transfers to the mains bypass supply.

From a 'power' viewpoint, each module is internally identical to the 'single module' configuration. A parallel system requires inter-module control signals to manage the load sharing, synchronizing and bypass switching. The control signals are connected through the parallel cables, which are multi-way ribbon cables connected between the units of the system to form a ring.

When two or more modules are to be connected in parallel, it is recommended that inductor should be inserted in the static bypass line. This can be installed internal to the UPS as an option.

### 7.2 System Installation Procedures

The basic installation procedure of a parallel system comprising two or more UPS modules is the same as that of single module system. This section only introduces the installation procedures specific to the parallel system. The installation of a parallel UPS should follow the installation procedure for a single UPS module with the additional requirements detailed in this section.

#### 7.2.1 Preliminary Checks

Be sure that the options of the parallel cables are correct, and that the modules are of the same rating, model, and with the same software and hardware release.



**Warning**

To achieve coordinated operation of the modules in the parallel system, it is required to configure each module separately using Vertiv setting software. This must be done by Vertiv service personnel.

#### 7.2.2 Cabinet Installation

Place the UPS modules side by side and interconnect as shown in Figure 7-1. The output distribution mode (Q1EXT, Q2EXT must be configured) shown in Figure 7-1 is recommended to facilitate maintenance and system testing.

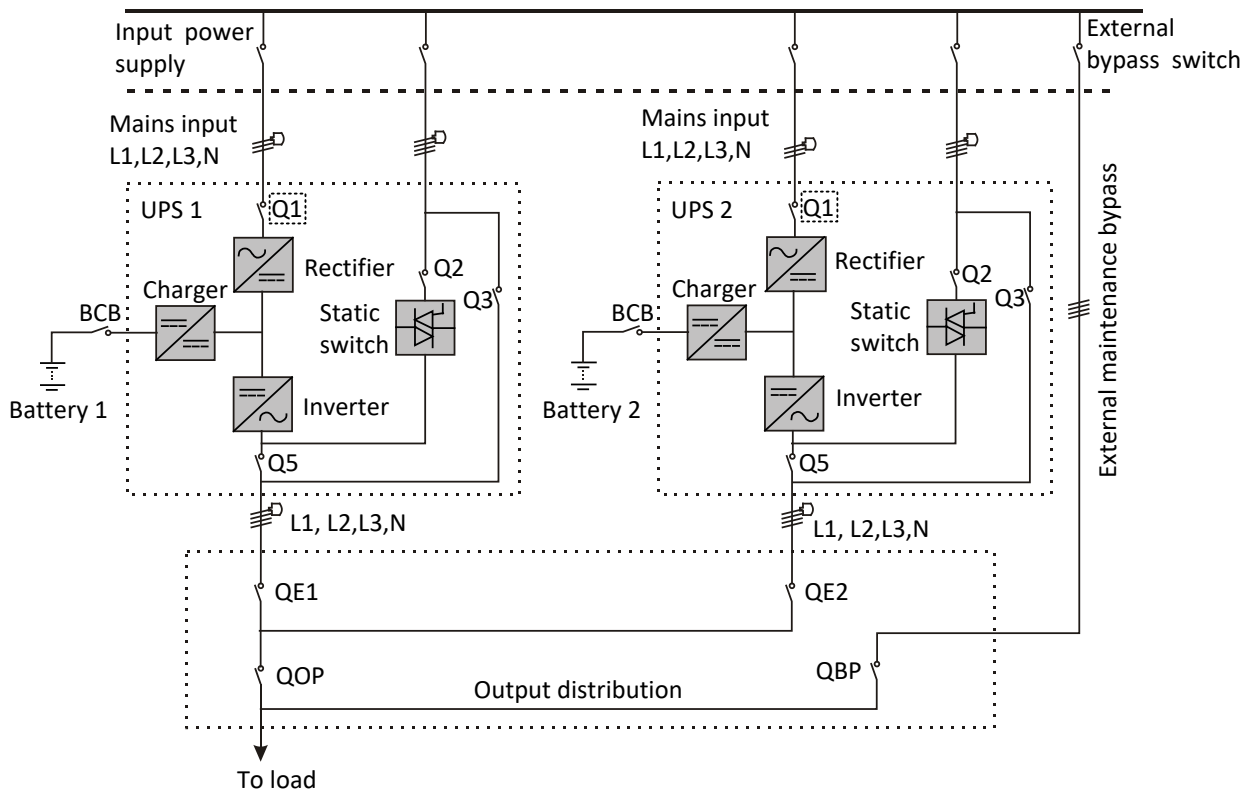

Note: Q1, Q2 and Q5 are optional while Q3 is standard

Figure 7-1 Schematic of typical parallel system (with common input, separate batteries and output)

### 7.2.3 External protective device

	<b>Warning</b>
<ol style="list-style-type: none"> <li>1. High earth leakage current: Earth connection is critical before connecting the input supply (including both mains supply and battery).</li> <li>2. The equipment must be earthed in accordance with the local electrical code of practice.</li> </ol>	

Refer to 3.1.9 External Protective Device.

### 7.2.4 Power Cable

The power cable wiring is similar to that of the UPS module. Refer to 3.1 Wiring Of Power Cable.

The bypass and rectifier input supplies must use the same neutral line input terminal. If the input has a current leakage protective device, the current leakage protective device must be fitted upstream of the neutral line input terminal.

	<b>Note</b>
<ol style="list-style-type: none"> <li>1. The power cables (including the bypass input cables and UPS output cables) of each UPS module should be of the same length and specifications to facilitate load sharing.</li> <li>2. The UPS adopts common input configuration and split bypass configuration. If the mains input and bypass input come from two different transformers, then these two transformers should share one grounding grid.</li> </ol>	

## 7.2.5 Parallel Cable

Shielded and double-insulated parallel cables available in lengths 5m, 10m and 15m must be interconnected in a ring configuration between the UPS modules, as shown in Figure 7-2. Method: connect a module parallel cable from its PARA1 port to the PARA2 port of another module. Follow this method to connect other parallel cables.

The parallel port J20 is provided on the front panel of the bypass module, as shown in Figure 7-3.

The ring connection ensures the reliability of the control of the parallel system. Be sure to verify the reliable cable connection before starting up the system!

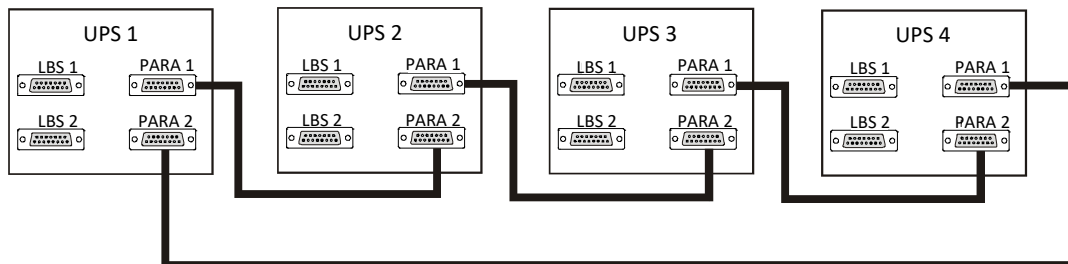

Figure 7-2 Parallel signal cables connection (Parallel system)

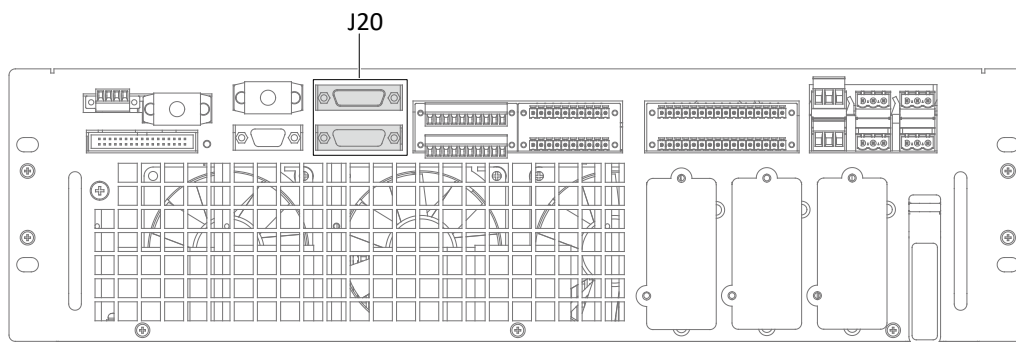

Figure 7-3 Location of parallel port J20 on bypass module

## 7.2.6 Remote EPO

In addition to the EPO switch provided on the operator control and display panel of each UPS module for controlling the EPO of each module respectively, the parallel system also provides remote EPO function for controlling all UPS modules to shut down simultaneously from a remote terminal, as shown in Figure 7-4.



### Note

1. The remote EPO switch must provide dry contact signal, which is normally open or normally closed.
2. The open circuit voltage provided is 12Vdc, < 20mA.
3. The external EPO device can be composed of another control system which can disconnect UPS mains supply or bypass input.
4. Pins 1 and 2 of the normally closed EPO-J2 port on the bypass module have been linked in factory.

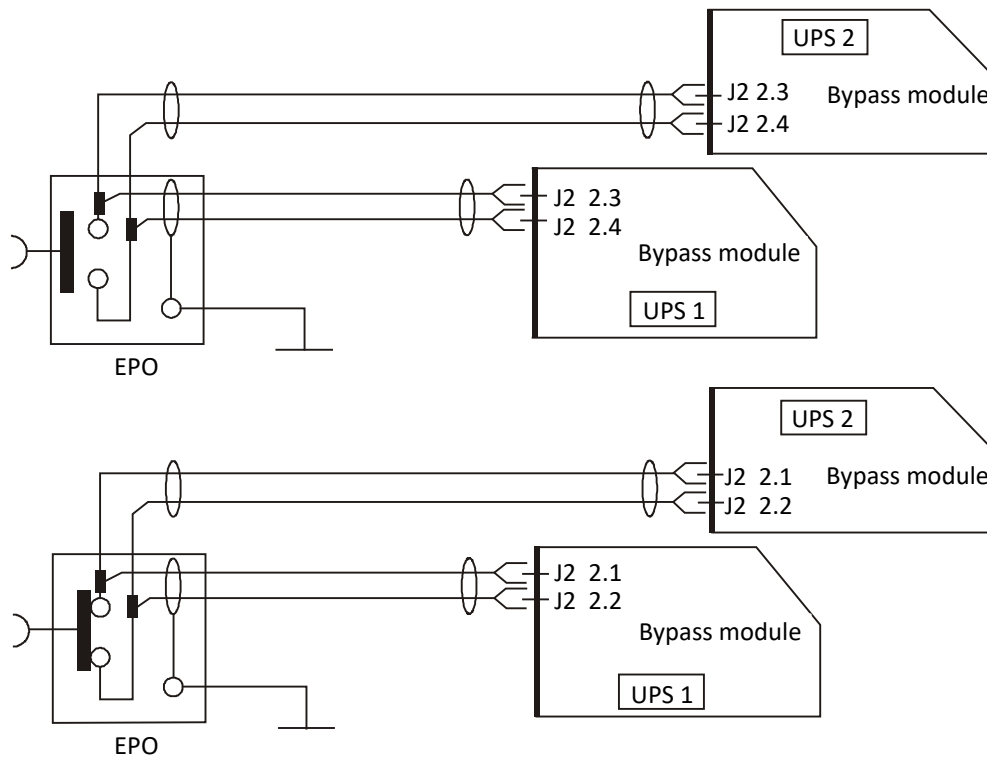

Figure 7-4 EPO circuit diagram

Note: In Figure 7-4, the upper one is Normally Open type, and the lower one is Normally Closed type.

### 7.3 Operation Procedures For Parallel System



Warning

If UPS input uses RCD, differential switch is only used in the system's bypass mains supply. At the moment of electrical connection, current may not be immediately separated, which may result in the tripping of RCCB respectively.

Only one step is needed for once, and only after finishing this operation step of each UPS module, the next step can be carried on.

#### 7.3.1 Startup Procedures In Normal Mode

These procedures are applicable to start the UPS under total power-down state, which means the UPS or the maintenance bypass switch has not supplied the load before. Make sure UPS has been completely installed and commissioned by the engineer, and external power supply switch has been turned off.



Warning

1. These procedures result in mains voltage being applied to the UPS output terminals.
2. If any load equipment is connected to the UPS output terminals, check with the user that it is safe to apply power. If the load is not ready to receive power, disconnect the downstream load switch, and stick a warning label on the connection point of the load.



Use the following procedures to turn on the UPS from a fully powered down condition.

1. Confirm that the total external maintenance bypass switches are disconnected. Open the front door of each UPS in turn, ensure that the internal maintenance bypass switch Q3 is disconnected, while the input cables and copper bars are reliably connected, and the parallel cables are firmly connected.



**Warning**

To avoid misreporting as faults, all operations relating to disconnection or connection of the maintenance bypass switch shall be finished within three seconds.

2. Close the total bypass input switches.
3. Close the output switch Q5, bypass input switch Q2, rectifier input switch Q1, and all external output isolating switches (if any) of each UPS in turn.

At the moment, the system is powered on, and the startup screen pops up.

About 25 seconds later, confirm that the TOUCHSCREEN shows the rectifier power supply and the bypass power supply are normal; if not, check whether the switches Q1 and Q2 are closed. Then the rectifier starts up, about 30 seconds after the rectifier enters normal operation, the bypass static switch is closed.

4. When the rectifier start process is finished and the rectifier indicator goes solid green, close the external BCB.
5. For each UPS, manually turn on the inverter. The inverter starts up, the whole UPS system will power the load.

### 7.3.2 Maintenance Bypass Procedures



**Warning**

If the UPS system is composed of more than 2 parallel UPS modules, and the load capacity exceeds the single module capacity, do not use the internal maintenance bypass switch.

This operation will make the load transfer from UPS power supply protection state to direct connection with AC input bypass state.



**Caution: power supply interruption danger of the load**

Before performing this procedure, you should check the touchscreen information first, and make sure the bypass is normal and inverter synchronized. Otherwise, it may result in the load power interruption for a while.

1. Manually turn off the inverter of each UPS in turn. The power flow diagram shows INVERTER OFF, and the buzzer alarms. The load transfers to the static bypass, and the inverter shuts down. At last, all UPSs are transferred to Bypass mode.



**Note**

Press the SILENCE button can silence the alarm, but the alarm message of the the TOUCHSCREEN does not disappear until the alarm status is cleared.

2. Close the UPS external total maintenance bypass switches, and do not close the internal maintenance bypass switch Q3 of each UPS.
3. At this moment, the external total maintenance bypass should be parallel connected with each UPS's static switch.
4. At this moment, the TOUCHSCREEN of each UPS displays ' Maint. Switch Closed'.
5. Disconnect the output switch Q5 of each UPS in turn, and the maintenance bypass can supply power to the load.



**Caution**

When the UPS is in maintenance mode, the load does not have the mains abnormal protection.

6. Pressing the EPO button of each UPS stops the operation of rectifier, inverter, static switch and battery, but this action will not affect the maintenance bypass power the load normally.

**Note**

In maintenance mode, the load is directly fed by the mains power instead of the pure AC power from the inverter.

7. Disconnect the rectifier input switch Q1 and bypass input switch Q2 of each UPS in turn.

At the moment, all the internal power supply is off and the TOUCHSCREEN does not display any more.

**Warning**

1. If the maintenance is required, wait 10 minutes for the internal DC bus capacitance discharging.
2. The parts of UPS circuits also have hazardous voltage, though the rectifier input switch, bypass input switch and battery switch are disconnected. Therefore, the UPS maintenance is applicable to qualified personnel only.

### 7.3.3 Procedures For Isolating One UPS Module From Parallel System

**Important**

These procedures shall only be carried out by service personnel of Vertiv or under their guidance.

**Warning**

Before operation, confirm that the system capacity has redundancy to avoid system shutdown due to overload.

The following procedures apply when one UPS module must be isolated from the parallel system for repair due to serious fault:

1. Pressing the EPO button stops the operation of rectifier, inverter, static switch and battery, but this action will not affect other UPSs in parallel system to power the load normally.
2. Disconnect the external power mains switch, rectifier input switch Q1, external power bypass switch, bypass input switch Q2, output switch Q5, BCB and single module external output switch.
3. Correctly connect the remaining parallel cables in other single modules, refer to 7.2.5 *Parallel Cables*.

**Warning**

1. Post a label at the AC input distribution (generally far away from the UPS) to alert that the UPS maintenance is being operated.
2. Wait 10 minutes for the internal DC bus capacitance discharging. Then the UPS is completely shut down.

### 7.3.4 Procedures For Inserting One Isolated UPS Module In Parallel System

**Important**

These procedures shall only be carried out by service personnel of Vertiv or under their guidance.

The following procedures are used to reintegrate a UPS module that has been previously isolated from the parallel system:

1. Confirm that the I/O cable, battery cable and parallel cable of the single module are correctly connected.
2. Confirm that the maintenance bypass switch Q3 or the single module external maintenance switch is disconnected. Close the output switch Q5, external output switch, external power bypass switch, bypass input switch Q2, rectifier input switch Q1, and external power mains switch of each UPS in turn.
3. When the single module starts, close the BCB and then manually turn on the inverter.

After single module inverter starts a few seconds, the single modules form the parallel system for operation.

### 7.3.5 Procedures For Completely Powering Down UPS

Complete UPS shutdown and load power-off should follow this procedure. All power switches, isolating switches and breakers are disconnected, and then UPS no longer supplies power to the load.

**Caution**

The following procedures will cut off the load power, making the load completely power off.

1. Pressing the EPO button of each UPS stops the operation of rectifier, inverter, static switch and battery.
2. Disconnect the rectifier input switch Q1 and bypass input switch Q2 of each UPS. At the moment, all the internal power supply is closed and the TOUCHSCREEN does not display any more.
3. Disconnect the output switch Q5 of each UPS.

**Warning**

1. Post a label at the AC input distribution (generally far away from the UPS) to alert that the UPS maintenance is being operated.
2. Wait 10 minutes for the internal DC bus capacitance discharging. Then the UPS is completely shut down.

**Warning: hazardous battery voltage**

The battery terminals still have hazardous voltage after the UPS complete shutdown.

### 7.3.6 Procedures For Complete UPS Shutdown While Maintaining Power To Load

The following procedures are applicable for completely powering down the UPS and still keeping the power supply to the load. Refer to the procedures in 7.3.2 *Maintenance Bypass Procedures*.

## 7.4 LBS System

### 7.4.1 Cabinet Installation

An LBS system consists of two independent UPS systems, each containing one or more parallel UPS modules, as shown in Figure 7-5 and Figure 7-6. The LBS system has high reliability and is applicable to the load with multiple inputs. For single-input load, an STS can be installed to feed power to the load.

The system uses the LBS cables to keep the output of the two independent (or parallel) UPS systems in synchronization. One system is designated as the master, the other is designated as the slave. The operation modes of the parallel system comprise master and/or slave operation in normal or bypass mode.

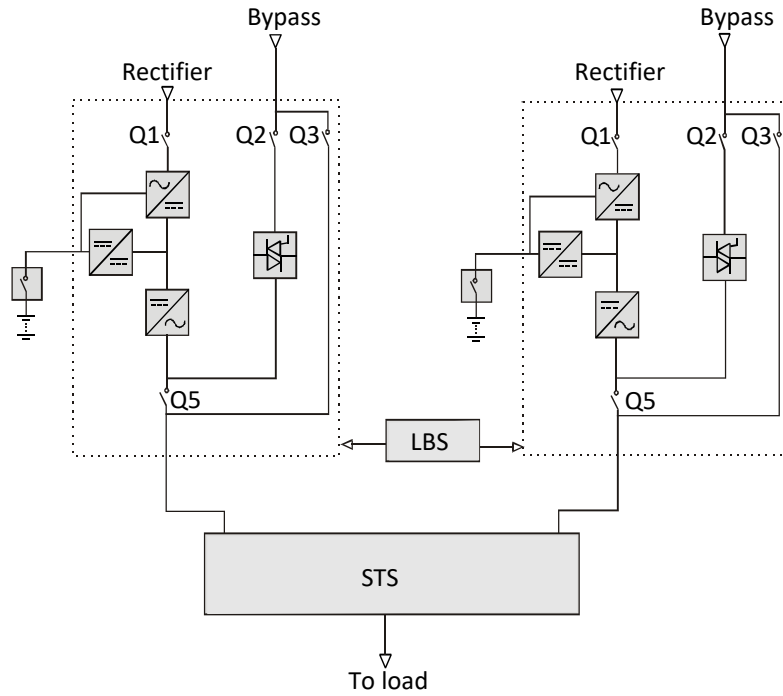

Note: Q1, Q2 and Q5 are optional while Q3 is standard

Figure 7-5 LBS system (UPS module)

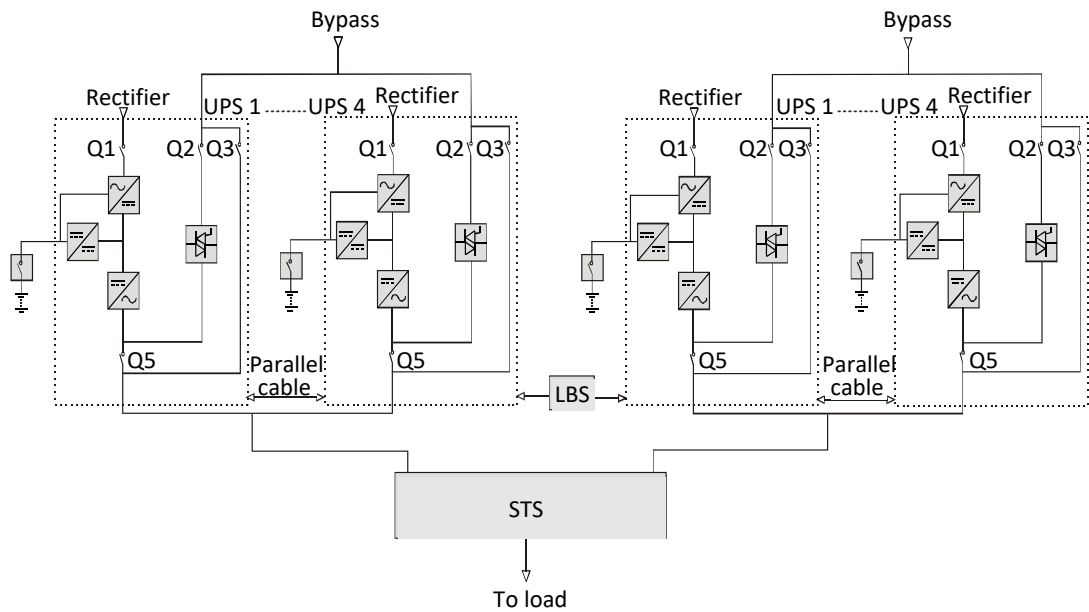

Note: Q1, Q2 and Q5 are optional while Q3 is standard

Figure 7-6 LBS system (parallel system)



**Note**

In a dual-bus system, the two UPS systems must have the same power rating, voltage and frequency, and the load should not exceed the power rating of a UPS module system.

**7.4.2 External Protective Device**

Refer to 3.1.9 External Protective Device.

### 7.4.3 Power Cable

The power cable of dual-bus power system is similar to that of single system. Refer to 3.1 *Wiring Of Power Cable*.

The bypass and rectifier input supplies must use the same neutral line input terminal. If the input has a current leakage protective device, the current leakage protective device must be fitted upstream of the neutral line input terminal.

### 7.4.4 LBS Cable

For 80kVA ~ 200kVA dual bus system, connect the optional LBS cables (10m, 15m, 20m) between the LBS ports (J19) of the two UPS systems shown in Figure 7-7 to Figure 7-8. The J19 ports are provided on the front panel of the bypass module, as shown in Figure 7-9.



#### Note

You must use the shortest LBS cable to suit the application and must not coil excess. Meanwhile, separate the LBS cable from the power cables to prevent electrical interferences.

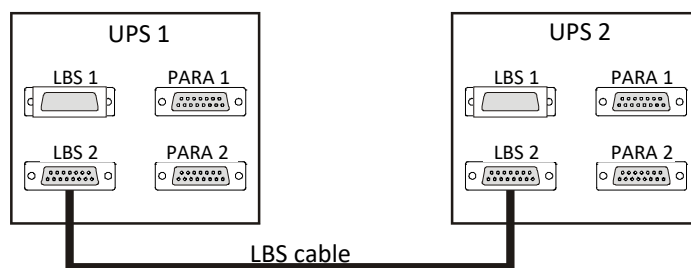

Figure 7-7 Connection of typical LBS system (UPS module)

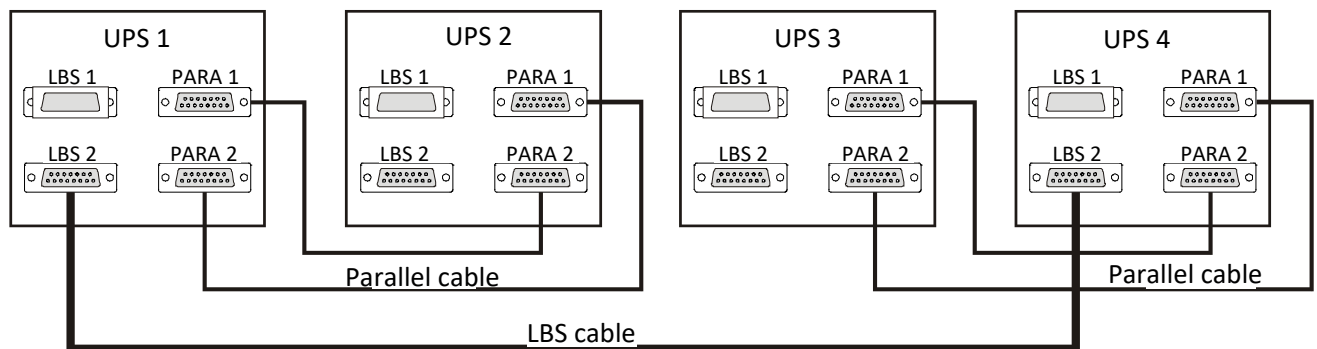

Figure 7-8 Connection of typical LBS system (parallel system)

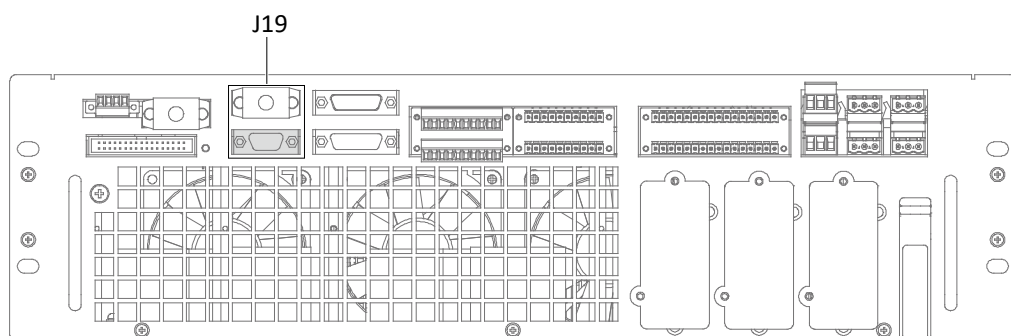

Figure 7-9 LBS port (J19) on bypass module

## Chapter 8 Options

This chapter provides the UPS option list, and introduces the functions, installation and configuration of each option.

### 8.1 Option List

Table 8-1 Option list

No.	Option name	Remark	Model
1	160 ~ 200kVA optional switch cabinet	Top cable incoming cabinet (assembled after delivery)	02359741
2	Bypass load sharing inductor kit	80kVA ~ 120kVA, 160kVA ~ 200kVA	02359942, 02359737
3	Battery temperature sensor kit	Battery temperature sensor kit	023500U7 (Connection via the BCB) 023500N1 (Direct connection to the UPS)
4	Battery ground fault kit	Battery ground fault kit	023500U6
5	Seismic anchor kit	Common for 80kVA ~ 200kVA	02359734
6	IS-UNITY-DP card	Intellislot ports 1 ~ 3 (port 1 or 2 recommended)	03020728
7	SIC card (Available only in selected region)	Intellislot ports 1 ~ 3 (port 1 or 2 recommended)	02351817
8	IS-Relay card	Intellislot port 1	02359487
9	BCB box	Battery control box	02359740
10	C2 Electromagnetic Shielding Assembly	80 ~ 120kVA C2 electromagnetic shielding assembly	023500U8
		160 ~ 200kVA C2 electromagnetic shielding assembly	02359738
11	Parallel cable	Available in 5m, 10m, 15m	04112066 (5m), 04112067 (10m), 04112068 (15m)
12	LBS cable	Available in 10m, 15m, 20m	04112069 (10m), 04112070 (15m), 04112071 (20m)

## 8.2 Option Introduction

### 8.2.1 Optional Switch Cabinet

Parallel cabinet mechanical dimensions

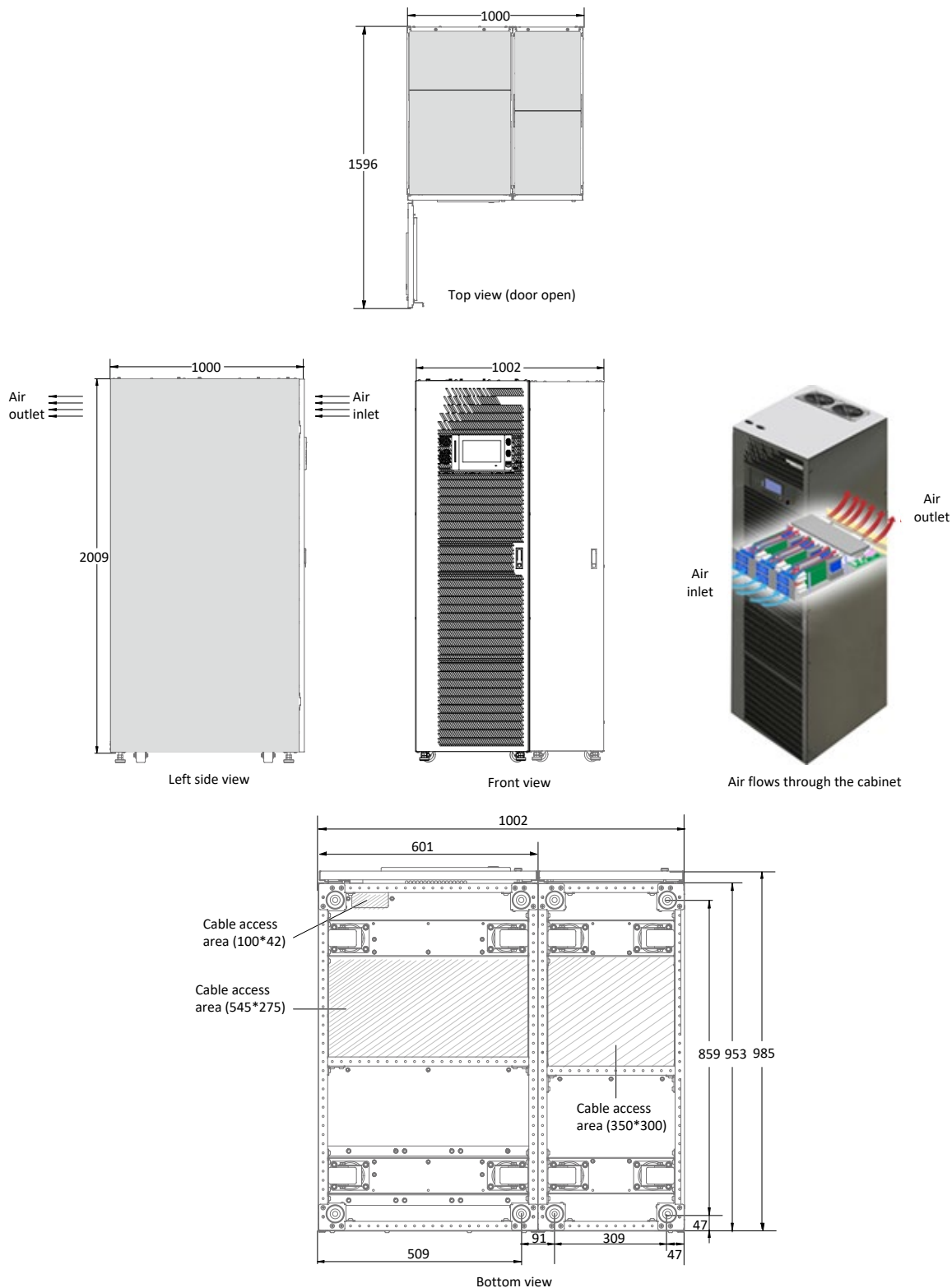
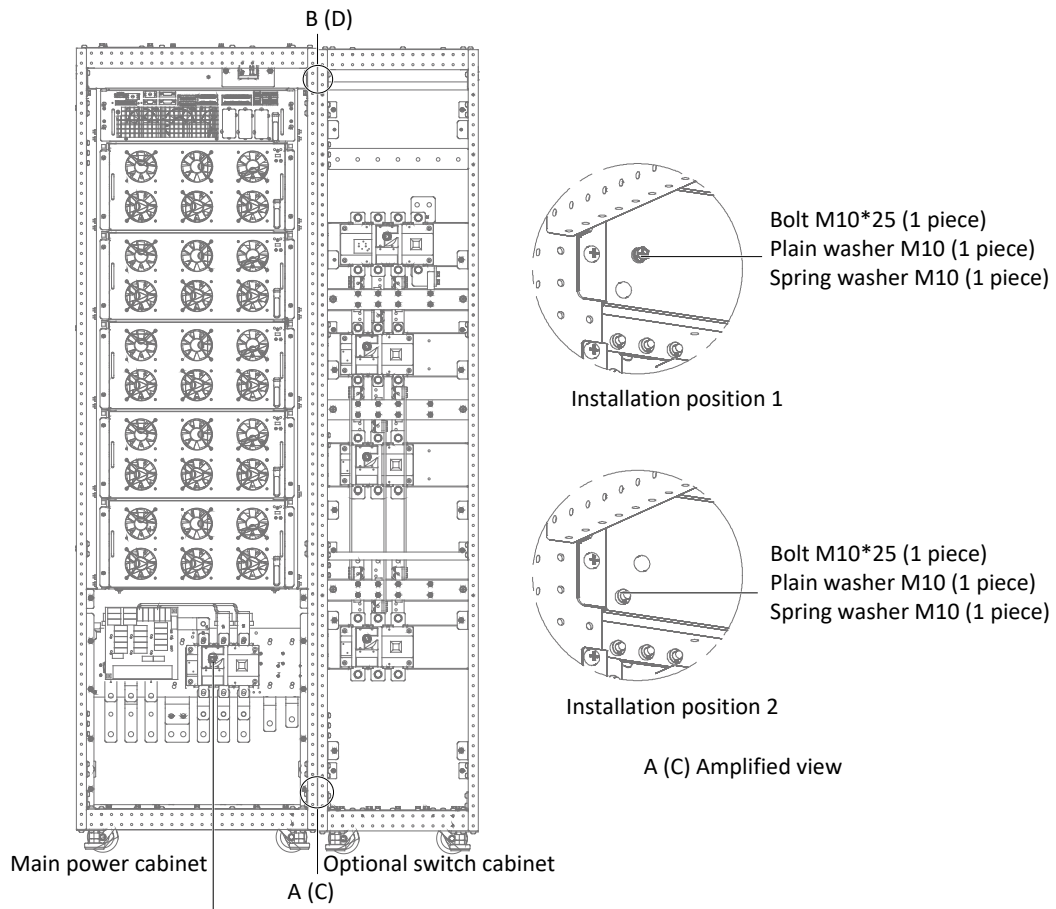

Figure 8-1 Top/front/side/bottom view of the 160kVA ~ 200kVA UPS (with optional switch cabinet) (unit: mm)

**Parallel cabinet mechanical connection**

The power cabinet and optional switch cabinet need to be connected at installation site, see Figure 8-2.



After parallel installation, remove the handle and extension bar at bottom of the main power cabinet, then use the dummy plate (accessory) to cover the hole.

Remove the socket head cap screw, and pull the extension bar.

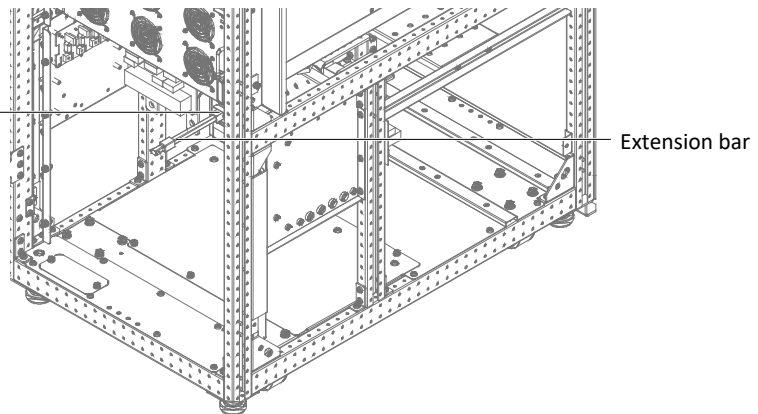

Figure 8-2 Mechanical cabinet connection



**Note**

After parallel installation, remove the handle and extension bar at bottom of the main power cabinet, then use the dummy plate (accessory) to cover the hole. Note that the label of Q3 should be removed because the Q3 is not used any more. Then ensure that the switch is in OFF state, see the image below:



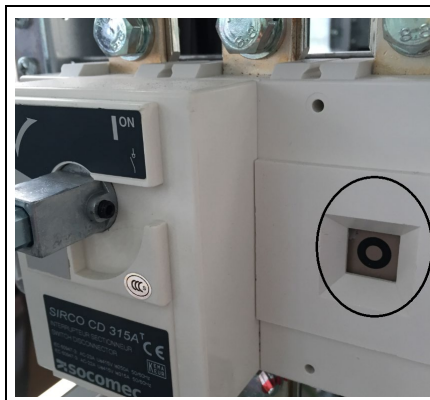

### Parallel cabinet electrical connection

1. Connect the mains, bypass and output terminals between the main power cabinet and optional switch cabinet according to the specific wire number. See Figure 8-3.

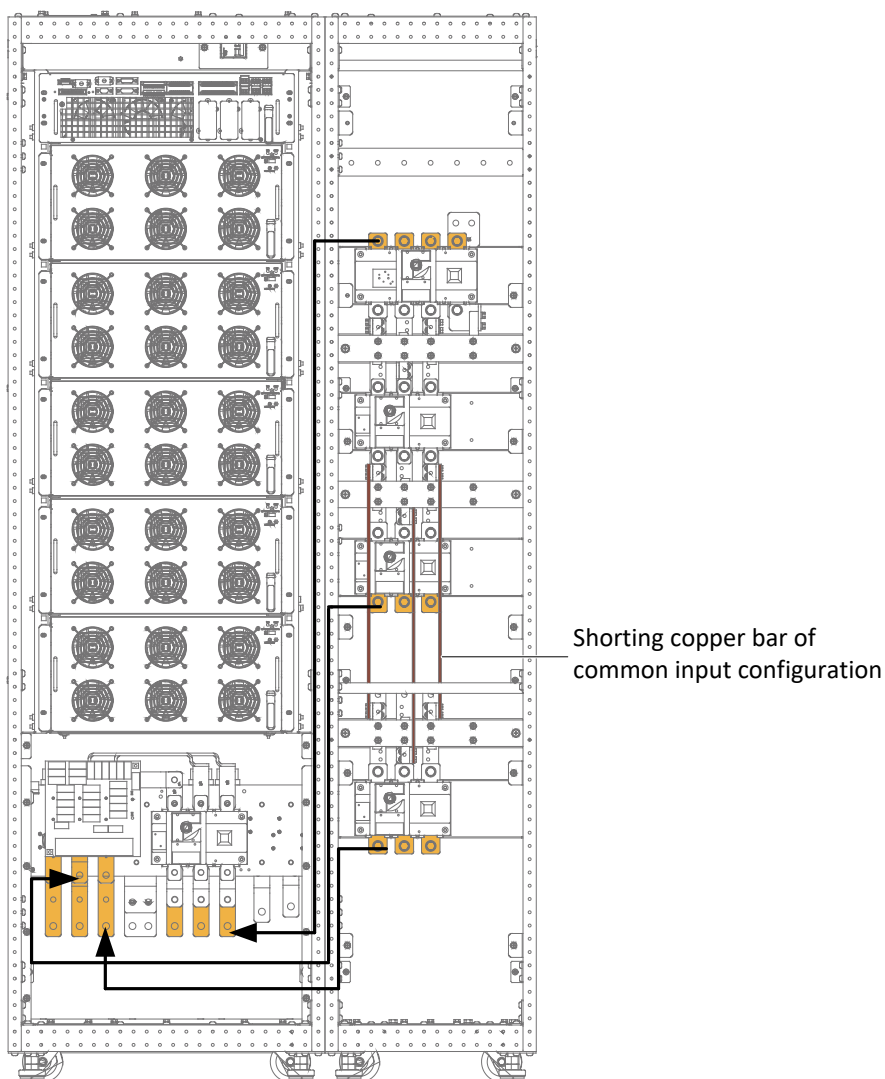
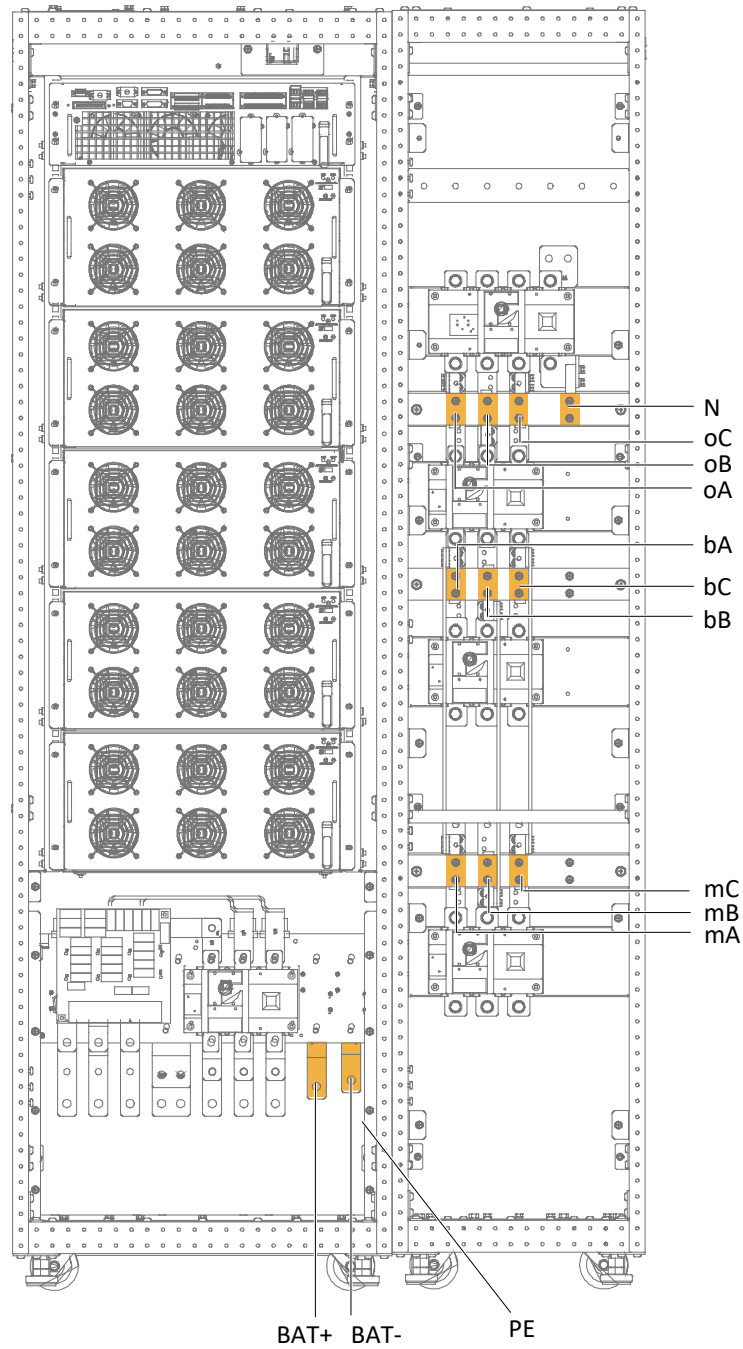

Figure 8-3 Parallel cabinet electrical connection

2. Remove the shorting copper bar of common input configuration in the main power cabinet. See Figure 3-2.
3. If the system is the split bypass configuration, just remove the shorting copper bar of common input configuration in the optional switch cabinet. See Figure 8-3.

### User connection

The connection terminals of the power cables are shown in Figure 8-4.



**Note:**

1. BAT+, BAT-: Battery input terminals
2. mA, mB, mC: Mains input terminals
3. bA, bB, bC: Bypass input terminals
4. oA, oB, oC: Output terminals
5. PE: Protective earth
6. N: Neutral line terminal of input, output and battery

Figure 8-4 Connection terminals of the power cables of 160kVA~200kVA (with optional switch cabinet)



**Note**

For parallel cabinet, the N line of user I/O and battery must be connected to the corresponding positions in optional switch cabinet instead of main power cabinet.

Figure 8-5 to Figure 8-6 show the power cable entry and routing methods.

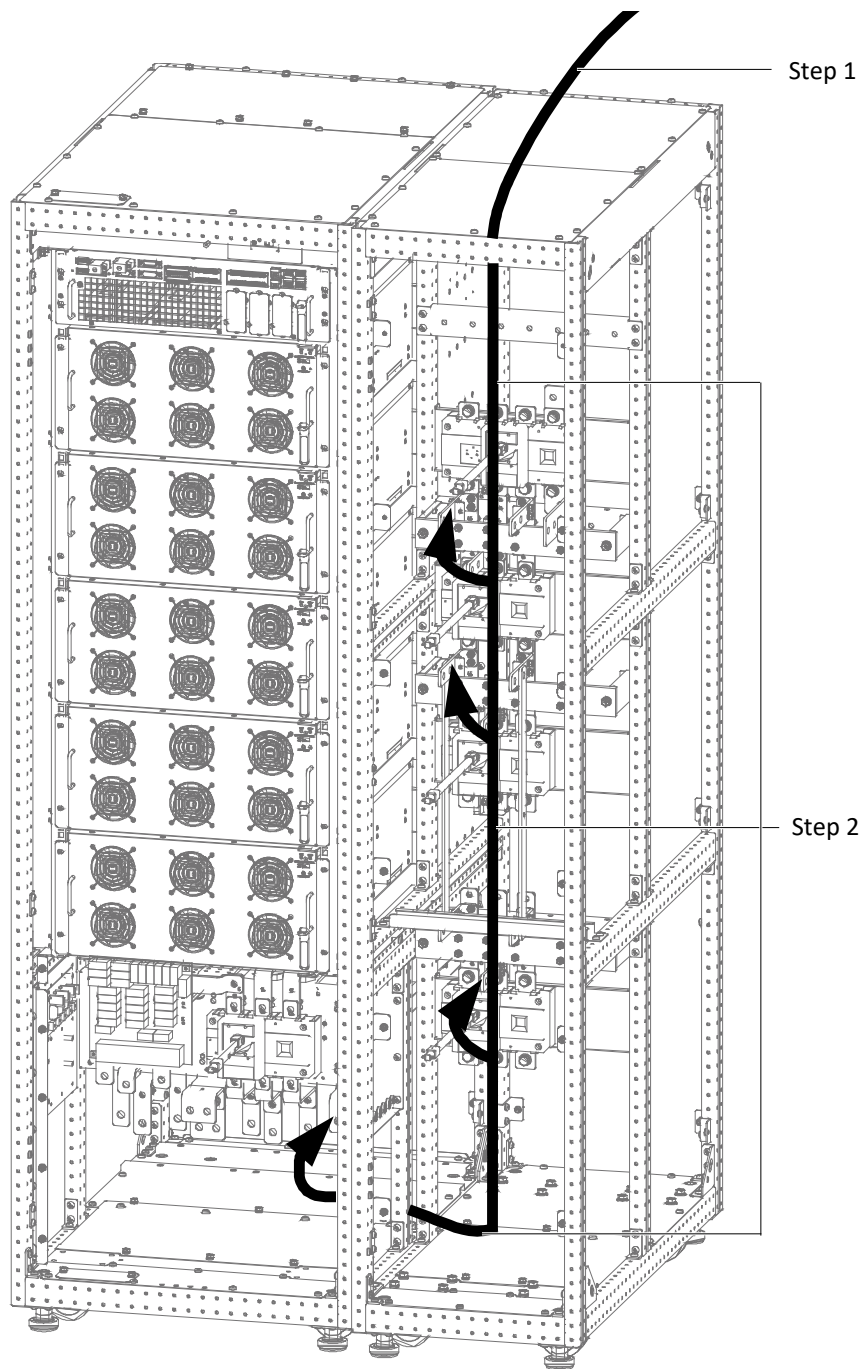

**Note:**

Step 1: Remove this top cover, make holes according to the cables number and size, then lead cables into the cabinet.

Step 2: Route cables along the cabinet inside, and use cable ties to bind them, then connect them to corresponding terminals.

Figure 8-5 Power cables connection of 160kVA~200kVA (with optional switch cabinet, top cable access)

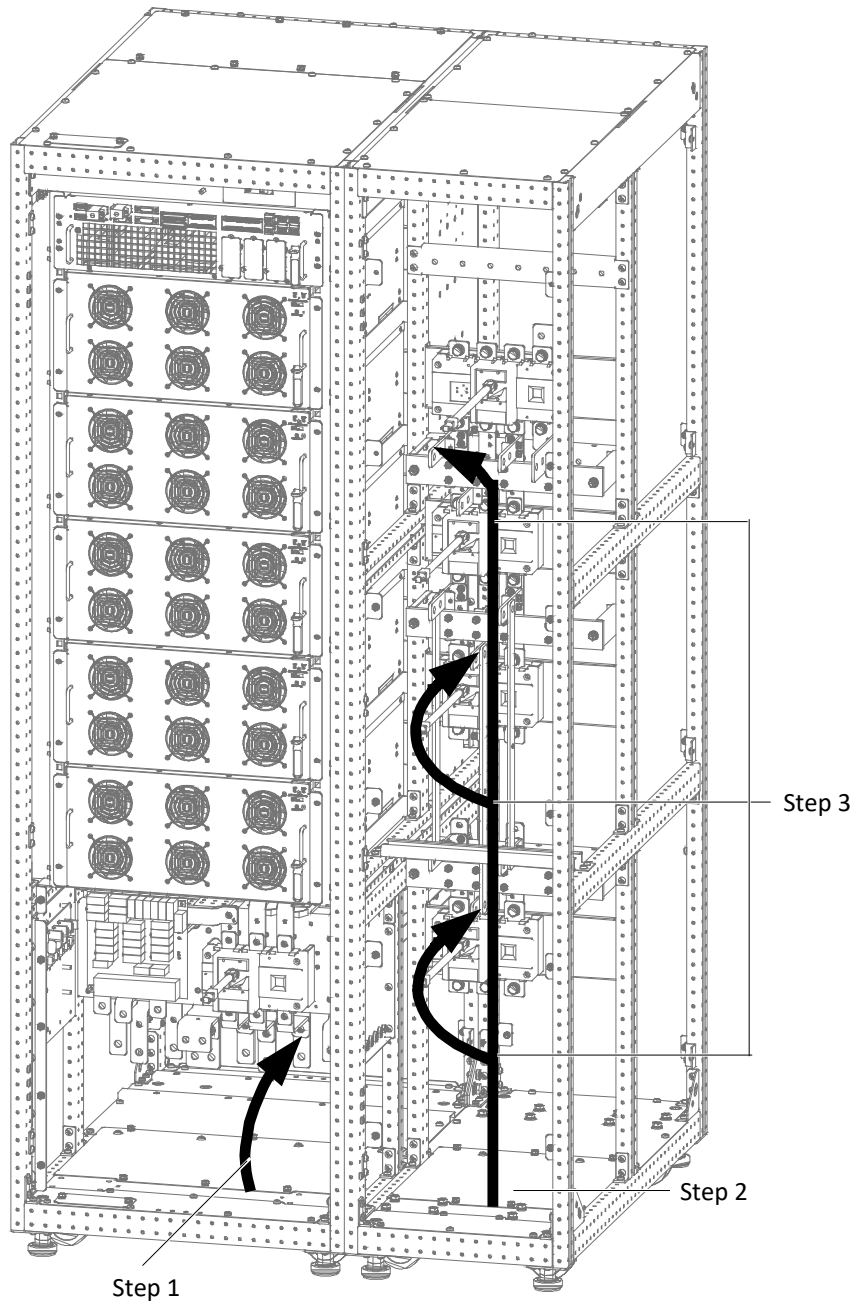
**Note:**

**Step 1:** Remove this bottom plate, make holes according to the cables number and size, then lead cables into the cabinet.

**Step 2:** Remove this bottom plate, lead cables into the cabinet.

**Step 3:** Route cables along the cabinet inside, and use cable ties to bind them, then connect them to corresponding terminals.

Figure 8-6 Power cables connection of 160kVA~200kVA (with optional switch cabinet, bottom cable access)



**Warning**

Before cables connection, make sure that all external and internal power switches of the UPS are off, and post necessary warning signs to prevent inadvertent operation of the switches. Meanwhile, measure the voltages between the UPS terminals and the voltages between the terminals and the earth.

**Note**

After connection, take appropriate measures to seal the cable entry holes.

Connect the signal cables for parallel cabinet according to Figure 8-7. Note that cable W215 has been bound at the column at rear of the optional switch cabinet before delivery. The user should unlock the cable W215 and connect it to the terminal J15 on parallel board X3. If any existing cable fixed on J15, just remove it and then perform the cable W215 connection.

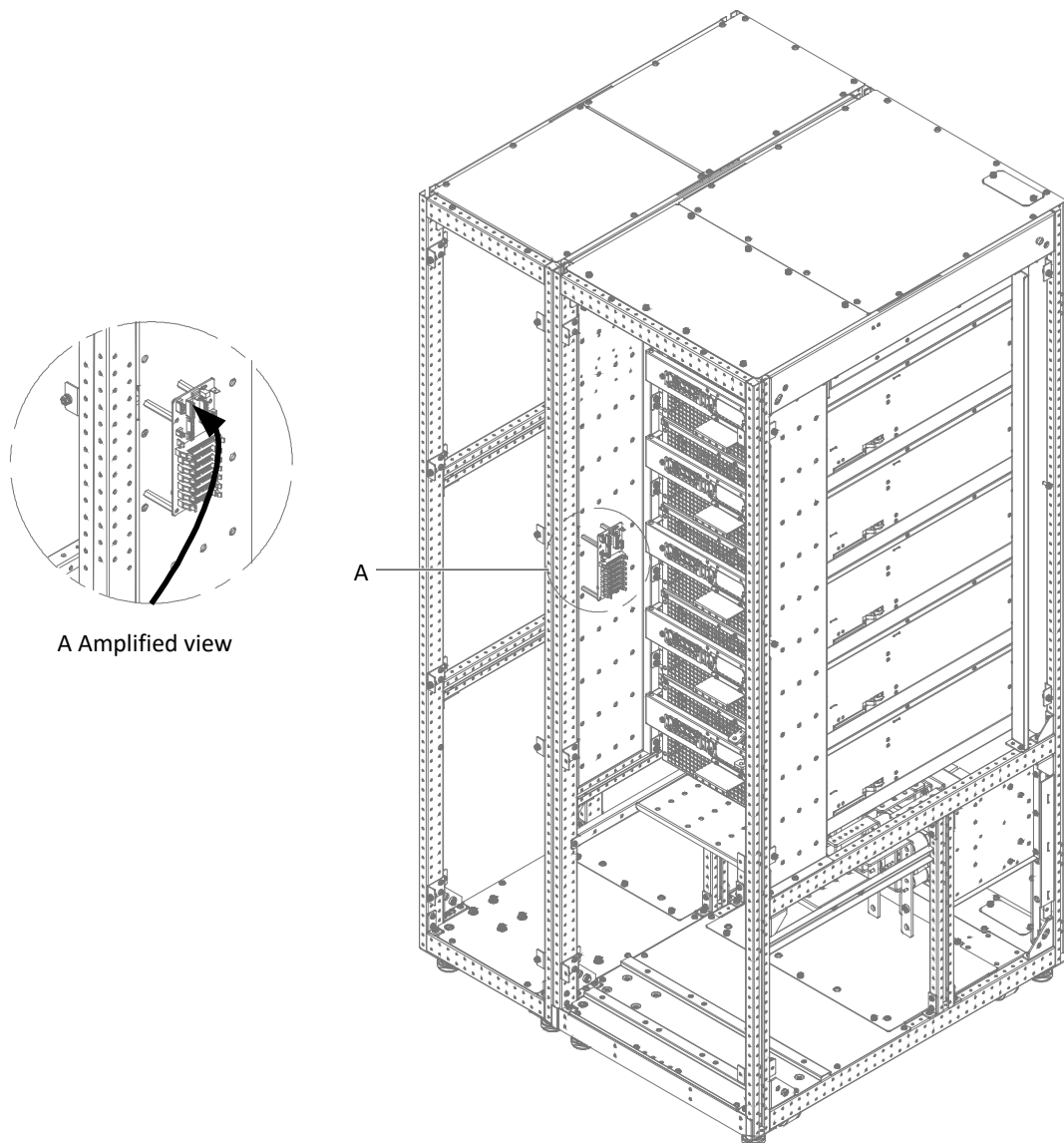

Figure 8-7 Signal cables connection of 160kVA-200kVA (with optional switch cabinet)

## 8.2.2 Bypass Load Sharing Inductor Kit

Install the bypass load sharing inductors for the parallel system comprised of two or more UPS modules, to ensure the bypass output load sharing for the parallel system. The bypass load sharing inductor is used to compensate the impedance differentia between SCR and cable. See Table 8-2 for the specifications.

Table 8-2 Specifications of bypass load sharing inductor

UPS	Dimensions (H × W × D) (mm)	Inductor value (uH)
80kVA ~ 120kVA	120 × 121 × 170	38.4
160kVA ~ 200kVA	170 × 148 × 187	21

Each UPS cabinet has three bypass load sharing inductors, with no extra clearance occupied. The load sharing rate is generally 10% of the system rated current with the difference of external cable configuration. Try to make the cable length be the same from bypass to each UPS and from UPS module output to parallel system connection point.

### Preparation

1. Prepare the installation tools, including an electric screwdriver, a screw driver, a torque sleeve and a red marker.
2. Check that all installation materials, types and cables are present and complete, and that auxiliary materials (such as fastener, heat shrinkable tube and wire clasp) are present and in good condition.

### Procedures



1. Only authorized personnel shall install and replace the inductors.
2. Connect the cables strictly following the instructions. Failure to observe this may cause damage to the UPS and the inductors.

### EXM 80kVA ~ 120kVA

1. Disconnect all input power of the UPS, such as battery and load.
2. All the TOUCHSCREENS are off, wait five minutes for the internal DC bus capacitors of the UPS complete discharging.
3. Remove the left panel, front panel and rear panel of the UPS cabinet, reserve the removed screws.
4. Remove the cables W61, W62 and W63 from terminals bA, bB and bC, see Figure 8-8.

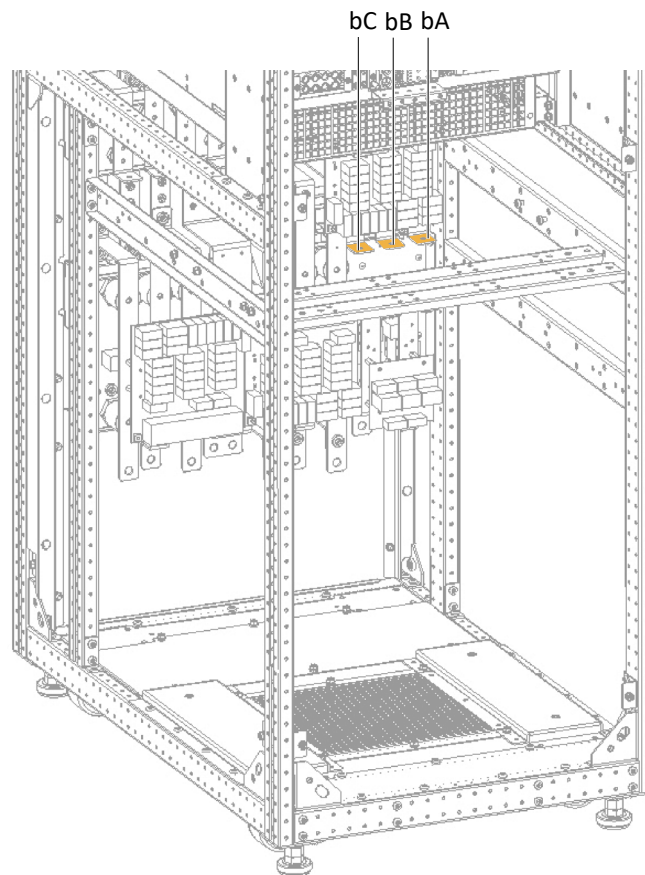

Figure 8-8 Removing cables

5. Place the three inductors (A, B, C) in the installation position and fix them with twelve hexagon sems screw M8 × 20, as shown in Figure 8-9.

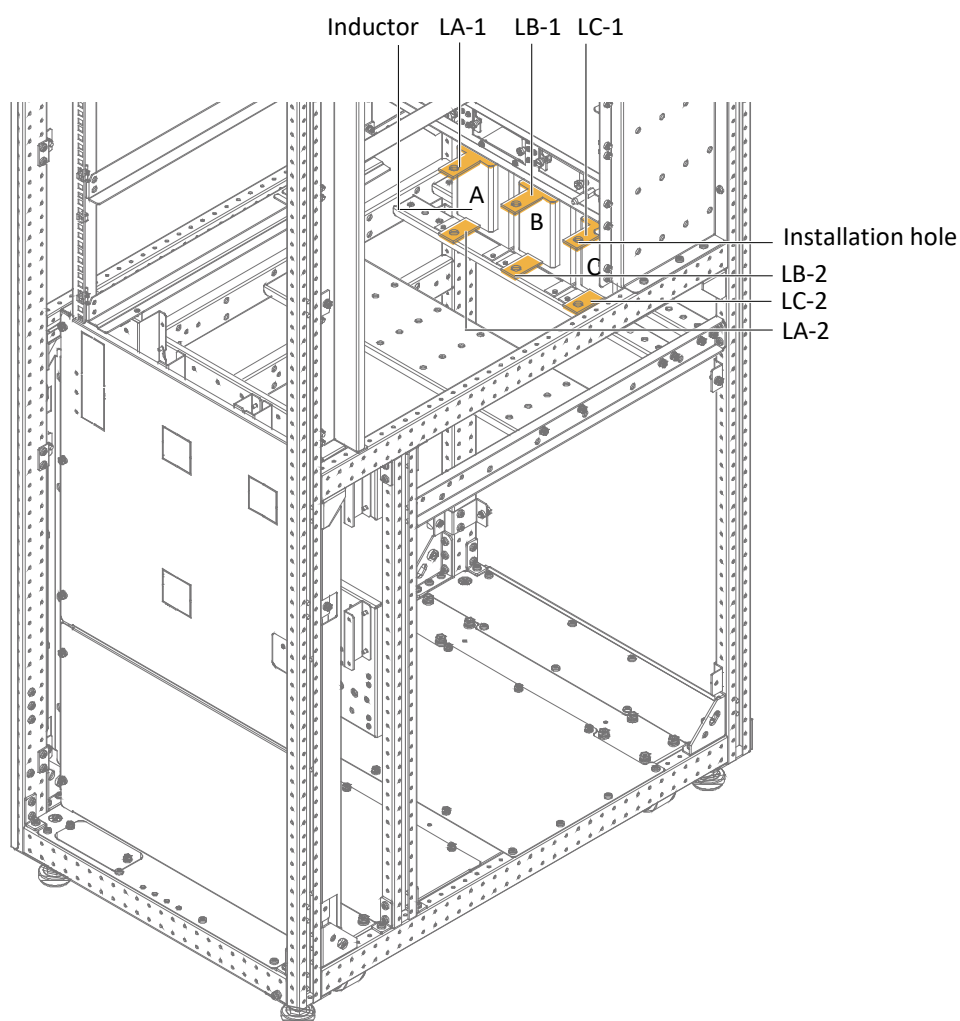

Figure 8-9 Installing bypass load sharing inductors

6. Use hexagon sems screw M8 × 20 (6 pcs), plain washer 8 (6 pcs) and hexagon nut M8 (6 pcs) to respectively connect cables (W61, W62 and W63) to the terminals (LA-1, LB-1, LC-1) of the bypass load sharing inductors.

7. Then connect one end of the cable (W81, W82 and W83) to the terminals (LA-2, LB-2, LC-2) of the bypass load sharing inductors, and the other end to the terminals (bA, bB, bC).

8. After finishing the above procedures, you should check that cables are connected correctly.

The installation and connection of the bypass load sharing inductor assembly for EXM 80kVA ~ 120kVA UPS is complete.

#### EXM 160kVA ~ 200kVA

1. Disconnect all input power of the UPS, such as battery and load.
2. All the TOUCHSCREENS are off, wait five minutes for the internal DC bus capacitors of the UPS complete discharging.
3. Remove the left panel, front panel and rear panel of the UPS cabinet, reserve the removed screws.
4. Remove the cables W61, W62 and W63 from terminals bA, bB and bC, see Figure 8-10.

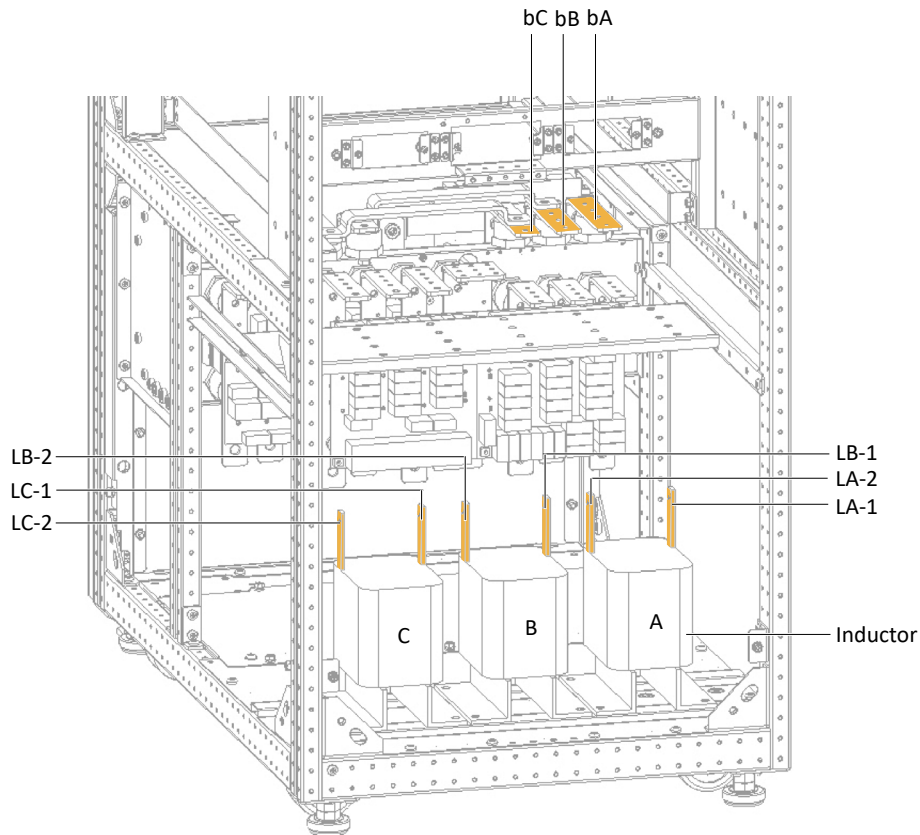

Figure 8-10 Position of bypass load sharing inductors

5. Place the three inductors (A, B, C) in the installation position and fix them with twelve hexagon sems screw  $M8 \times 20$ , as shown in Figure 8-10.
  6. Use hexagon sems screw  $M8 \times 20$  (6 pcs), plain washer 8 (6 pcs) and hexagon nut  $M8$  (6 pcs) to respectively connect cables (W61, W62 and W63) to the terminals (LA-1, LB-1, LC-1) of the bypass load sharing inductors.
  7. Then connect one end of the cable (W81, W82 and W83) to the terminals (LA-2, LB-2, LC-2) of the bypass load sharing inductors, and the other end to the terminals (bA, bB, bC).
  8. After finishing the above procedures, you should check that cables are connected correctly.
- The installation and connection of the bypass load sharing inductor assembly for EXM 160kVA ~ 200kVA UPS is complete.

#### Maintenance

1. Keep the connections tight. Tighten all connections in installation, and periodically check them.
2. Keep the inductors clean. Maintain the inductors free of dust and moisture.
3. Keep good records. Inform the service engineer for on-site maintenance in time.

### 8.2.3 Battery Temperature Sensor Kit

A battery temperature sensor is used to measure the battery temperature. At this moment, the temperature sensor is connected with the UPS internal logic circuit.

With this feature fitted, the nominal float voltage supplied to the battery is adjusted so as to be inversely proportional to the ambient temperature of the battery cabinet or battery room. This prevents the battery being over charged at high ambient temperatures.

#### Preparation

1. Prepare the installation tools, including a cross head screwdriver.
2. Check that all installation materials are present and complete, including a battery temperature sensor.



## Procedures



### Warning

1. Connect the cables strictly following the instructions. Failure to observe this may cause damage to the UPS and the battery.
2. Shut down the UPS when installing the battery temperature sensor. During installation, do not touch the battery terminals, bared copper bars and components.

1. Shut down the UPS completely.
  - a) Close the load.
  - b) All the TOUCHSCREENS are off, wait five minutes for the internal DC bus capacitors of the UPS complete discharging.
2. Connect one end of the specified cable to either port of the battery temperature sensor, and the other end to corresponding port of IS-Relay card. Refer to Figure 6-5 for O23500U7 connection, but the O23500N1 should be directly connected to the corresponding port of the UPS bypass module.
3. Route and pack the cables in order. Note that the cables should be routed separately from the power cables, to avoid EMI.

### 8.2.4 Battery Ground Fault Kit

The UPS provides a battery ground fault detector to detect and remove battery ground fault so as to ensure reliable system operation. Residual current range monitored: 30mA ~ 5000mA; power supply: UHW241M5 auxiliary power supply board.

When a battery ground fault is detected, an alarm will appear on the UPS display panel.

The battery ground fault detector includes a mutual inductor and a PCB, which should be installed in the BCB box. For the installation and connection of the battery ground fault detector, refer to 6.11

Battery Ground Fault Detector (Option).

**8.2.5 Seismic Anchor Kit**

The UPS provides seismic anchor kits to avoid and reduce the damage to UPS caused by earthquake or vibration. See Table 8-3 for dimensions of the seismic anchor kit.

Table 8-3 Dimensions of the seismic anchor kits

Seismic anchor	Width (mm)	Length (mm)
Seismic anchor 1/2	44	220
Seismic anchor 3	55	550
Seismic anchor 4	55	550

After fixing the UPS onto the concrete floor, the seismic anchor kits should achieve Class 2 requirement of Table 2 in IEC60068.3.3 and satisfy the UBC 1994 standard (earthquake area 4 from fierceness to further fierceness).

 <b>Warning</b>
<ol style="list-style-type: none"> <li>1. Only Vertiv authorized engineers shall carry out the installation.</li> <li>2. Carry out the installation strictly following the instructions. Failure to observe this could cause personnel injury or damage to the UPS and seismic anchor kits.</li> </ol>

**Preparation**

1. Prepare the installation tools, including a cross head screwdriver, a torque spanner and an adjustable spanner.
2. Check that all installation materials are present and complete, including four seismic anchors, 36 M6 × 20 tapping screws, eight M12 expansion bolts.

**Procedures**

The installation procedures are as follows:

1. Lift up the UPS cabinet, and upraise the four feet, then remove the rear mechanical part, see Figure 8-11.

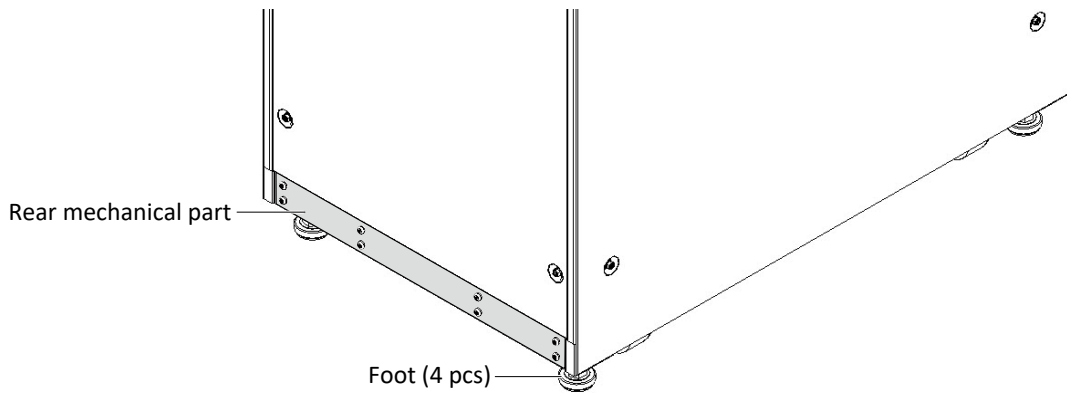

Figure 8-11 Removing adjustable feet

2. Use M6 × 20 tapping screws (18 pcs) to install seismic anchor 1 and seismic anchor 2 on the rear bottom of the UPS cabinet, as shown in Figure 8-12.

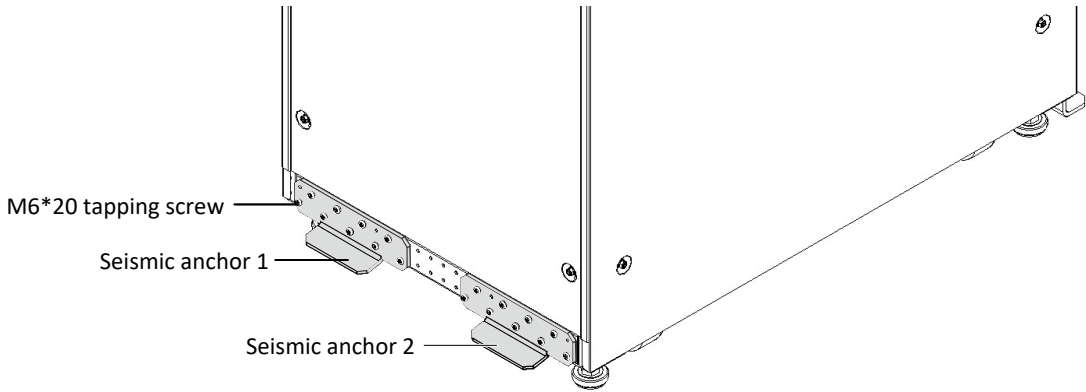

Figure 8-12 Installing seismic anchor 1 and seismic anchor 2

3. As shown in Figure 8-13, use four M12 expansion bolts to fix seismic anchor 3 on the ground, then push the UPS backward to insert seismic anchor 1 and seismic anchor 2 into the two holes of seismic anchor 3 respectively.

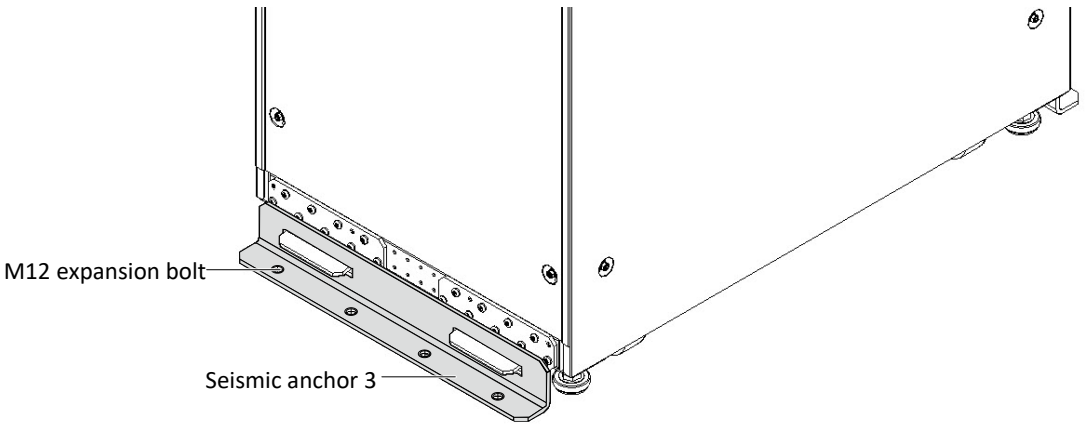

Figure 8-13 Installing seismic anchor 3

4. Use M6 × 20 tapping screws (14 pcs) to fix the seismic anchor 4 located at bottom of the cabinet front, and use four M12 expansion bolts to fix seismic anchor 4 on the ground, as shown in Figure 8-14.

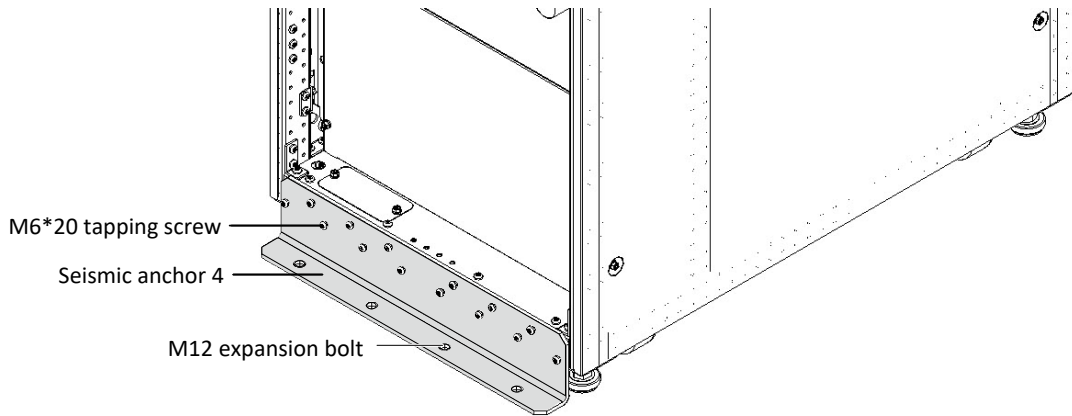

Figure 8-14 Installing seismic anchor 4

### 8.2.6 IS-UNITY-DP Card



#### Important

It is recommended to use the shielded cables to enhance the EMC.

The appearance of IS-UNITY-DP card is shown in Figure 8-15.



Figure 8-15 IS-UNITY-DP card

For further description of the IS-UNITY-DP card, refer to *Liebert IntelliSlot Unity Card User Manual-Web, SNMP, Modbus, BACnet, YDN23* in accessory.

### 8.2.7 IS-UNITY-LIFE Card



#### Important

It is recommended to use the shielded cables to enhance the EMC.

The appearance of the IS-UNITY-LIFE card is shown in Figure 8-16.



Figure 8-16 Appearance of IS-UNITY-LIFE card

For further description of the IS-UNITY-LIFE card, refer to *Liebert IntelliSlot™ Unity Card User Manual-Web, SNMP, Modbus, BACnet, YDN23*.

### 8.2.8 SIC Card

The SIC card is a network management card. It can make the UPS developed by Vertiv Tech Co., Ltd have network communication capability. It can also be connected to the IRM series sensor to provide environment monitoring function. When the intelligent equipment generates an alarm, the SIC card can notify the user by recording the log, sending trap information, and sending a mail. The SIC card supports Modbus RTU protocol.

#### Preparation

1. Prepare the installation tools, including a cross head screwdriver.
2. Check that all installation materials are present and complete, including an SIC card.

#### Procedures



Note

There is no need to shut down the UPS during SIC card installation, because the SIC card is hot pluggable.



Warning

Some electron components in SIC card are sensitive to static, therefore, do not touch the electron components or circuit in SIC card by hand or other conductive materials, so as to protect the SIC card against static shock. When removing or installing the SIC card, hold the card side edge to operate it.

The SIC card should be installed in the Intellislot port (see Figure 3-6) in the UPS. See Table 3-8 for installation positions of optional cards.

Method for installation:

1. Remove the cover of Intellislot port. Note to reserve the removed screws and take care of the cover for future use.
2. Insert the SIC card (along two sides of the Intellislot port) into the port position recommended in Table 3-8, and then fasten the screws.

For more information of the SIC card, refer to *Site Interface Web/SNMP Agent Card User Manual* in accessory.

Refer to 3.2.10 *Signal Cable Connection Steps* for the cabling and routing of the signal cables.

### 8.2.9 IS-Relay Card

The appearance of the IS-Relay card is shown in Figure 8-17.



Figure 8-17 Appearance of IS-Relay card

The UPS provides IS-Relay card for the user to use the dry contact signal to monitor the UPS. The functions of the IS-Relay card are listed in Table 8-4.

Table 8-4 Function of UPS IS-Relay card

Pin	Function	Operation
1	Common-Low Battery	
2	Low Battery	Closed if low battery point occurs
3	Low Battery	Closed if battery is OK
4	Common-UPS Fault	
5	UPS Fault	Closed if UPS fault occurs
6	UPS Fault	Closed if no UPS failure
7	Common-On Battery	
8	On Battery	Closed if On Battery power (Utility failure)
9	On Battery	Closed if not On Battery power (Utility OK)
10	Signal Ground	Future release
11	Signal Ground	Future release
12	UPS Any-Mode Shutdown	Future release
13	Summary Alarm	Closed if no alarm conditions are present
14	Summary Alarm	Closed if summary alarm occurs
15	Common-Summary Alarm	
16	On UPS	Closed if On UPS (inverter) power
17	On Bypass	Closed if On Bypass
18	Common-On Bypass	

For more information of the IS-Relay card, refer to the *Liebert IntelliSlot IS-Relay Card User Manual* in accessory.

The installation method of the IS-Relay card is the same as that of the SIC card described in 8.2.8 SIC card. Refer to 3.2.10 Signal Cable Connection Steps for the cabling and routing of the signal cables.

8.2.10 BCB Box

Refer to 6.9 BCB Box (Option) for more information about the specifications, battery connection of the BCB box.

8.2.11 C2 Electromagnetic Shielding Assembly

To satisfy the C2 requirement, the user dry contact signal cable needs to be led though the two magnet rings (accessories). See Figure 8-18.

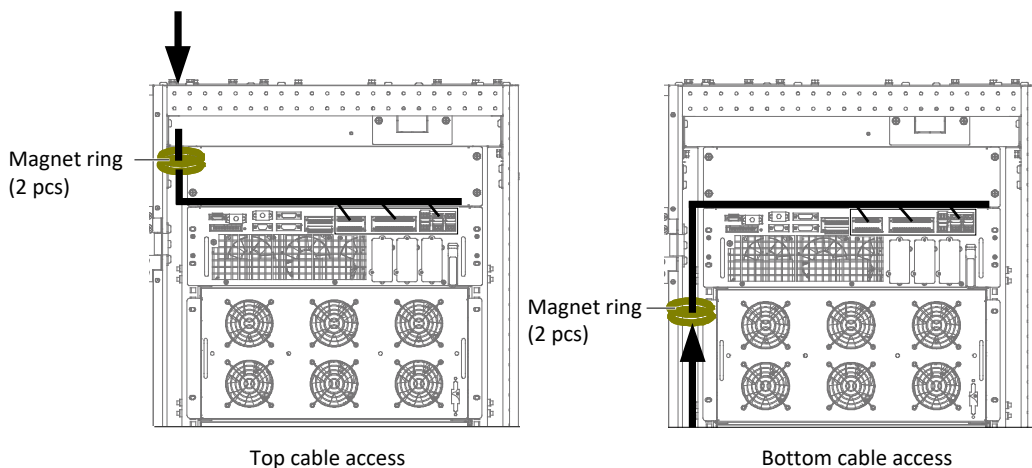

Figure 8-18 Schematic diagram of electromagnetic shielding for signal cables

### **8.2.12 Parallel Cable**

Shielded and double-insulated parallel cables available in lengths of 5m, 10m and 15m must be interconnected in a ring configuration between the UPS modules, as shown in Figure 7-2. Method: connect a module parallel cable from its PARA1 port to the PARA2 port of another module. Follow this method to connect other parallel cables.

The ring connection ensures the reliability of the control of the parallel system. Be sure to verify the reliable cable connection before starting up the system!

### **8.2.13 LBS Cable**

Shielded and double-insulated parallel control cables available in lengths of 10m, 15m and 20m. The LBS cable must be interconnected in a ring configuration between LBS1 and LBS2 of any UPS modules, as shown in Figure 7-7 and Figure 7-8.

## Chapter 9 Communication

The UPS supports SNMP protocol communication, Modbus protocol communication, and dry contact communication. This chapter provides information relevant to these types of communication.

Refer to corresponding settings in Table 4-4 for communication protocol. Selecting 'Velocity' means the system supports the Velocity protocol communication.

### 9.1 SNMP Protocol Communication

If you need to monitor the UPS through network, you may select the UNITY card or SIC card provided by Vertiv Tech Co., Ltd. The two cards all support SNMP protocol.

Both the UNITY card and SIC card are network management cards which make the UPS developed by Vertiv Tech Co., Ltd. real network equipment. It can also be connected to the IRM series sensor to provide environment monitoring function. When the intelligent equipment generates an alarm, the UNITY card and SIC card can notify the user by recording the log, sending trap information, and sending a mail.

The UNITY card and SIC card provide three approaches for you to monitor your intelligent equipment and equipment room environment:

- Web browser. You can use Web browser to monitor your intelligent equipment and equipment room environment through the Web server function provided by the UNITY card or SIC card.
- Network management system (NMS). You can use NMS to monitor your intelligent equipment and equipment room environment through the SNMP function provided by the UNITY card or SIC card.
- RDU-A, the network management software for equipment room power and environment. You can use RDU-A to monitor your intelligent equipment and equipment room environment through the TCP/IP interface provided by the SIC card.

The SIC card can also work with the Network Shutdown computer safe shutdown program developed by Vertiv Tech Co., Ltd. to provide automatic safe shutdown function for your computer installed with Network Shutdown, so as to avoid data loss.

The UNITY card should be installed in the Intellislot port (see Figure 3-8) in the UPS.

For further description of the IS-UNITY card, refer to *Liebert IntelliSlot Unity Card User Manual-Web, SNMP, Modbus, BACnet, YDN23* in accessory.

For the installation and setting information of the SIC card, refer to *Site Interface Web/SNMP Agent Card User Manual* for details.

### 9.2 Modbus Protocol Communication

The Modbus protocol communication is supported by UNITY card and SIC card.

### 9.3 Dry Contact Communication

The UPS provides the following two dry contact communication approaches:

- IS-Relay card
- Dry contact port



### 9.3.1 Communication Through IS-Relay Card

The UPS provides an IS-Relay card for the user to use dry contact signals to monitor the UPS. The IS-Relay card should be installed in an Intellislot port (see Figure 3-6) of the communication box in the cabinet. For the installation and use of the IS-Relay card, refer to *Liebert IntelliSlot IS-Relay Card User Manual*.

### 9.3.2 Communication Through Dry Contact Port

For on-site specific needs, the UPS may need auxiliary connection to achieve functions like acquiring external equipment status information, providing alarm signals to external devices, and remote EPO. The UPS has the following interfaces:

- Input dry contact port
- Output dry contact port
- EPO input port

For the functions and detailed information of these ports, refer to 3.2 *Wiring Of Signal Cable*.

## Chapter 10 Service And Maintenance

The UPS system (including battery) needs regular service and maintenance in long-term operation. This chapter elaborates on the advice on the service life, regular inspection, maintenance and replacement of the UPS key components. Effective maintenance of the UPS system can reduce the risk in UPS failure and prolong the UPS service life.

### 10.1 Safety



**Warning**

1. Inspection of UPS systems can only be executed by people who have received relevant training, and the inspection and replacement of devices should only be undertaken by authorized professionals.
2. The components that can only be accessed by opening the protective cover with tools cannot be operated by the user. Only qualified service personnel are authorized to remove such covers.
3. Note that the neutral line has hazardous voltage when servicing the UPS.

### 10.2 Service Procedures Of Power Module And Bypass Module

#### 10.2.1 Notes

1. Only customer service engineers shall service the power modules and bypass module.
2. Remove the power modules and bypass module from top to bottom, so as to prevent cabinet toppling due to high gravity center.
3. To ensure safety, before servicing the power modules and bypass module, be sure to use a multimeter to verify that the DC bus capacitor voltage is lower than 60Vdc, and that the voltages between the earth and the components you are going to work on are under dangerous voltage values, that is, lower than 60Vdc or 42.4Vac peak value.
4. Only when the UPS is transferred to internal or external maintenance bypass or completely powered off can the bypass module be removed.
5. The power modules and bypass module should be serviced 10 minutes after they are removed.

#### 10.2.2 Service Procedures Of Power Module

Provided that the UPS is in normal mode, and that the bypass is normal:

1. Press and hold the INVERTER OFF key on the operator control and display panel for two seconds to manually turn off the inverters, and the UPS transfers to bypass mode.
2. Close the maintenance bypass switch, and the UPS transfers to maintenance mode.
3. Place the ready switch on the front panel of the power module to the up position (that is, in unready state).
4. Disconnect the UPS input switch and output switch. In split bypass configuration, it is required to disconnect both input switches.
5. Ensure that the battery current is less than 2A. Open the BCB or disconnect the batteries
6. Two minutes later, remove the fixing screws on both sides of the front panel of the module, and pull the module out of the cabinet.



**Note**

The module will be blocked by a spring piece on the left side of the module when the module is pulled out of the cabinet halfway. At this point, you must press the spring piece before you continue to pull the module out.

7. After servicing the module, check that the address of this module is different from those of other modules and that the address ranges from one to five. Check that the ready switch is in unready state.
8. Push the module (at least 10s after another) into the cabinet, and tighten the screws on both sides. Then place the ready switch of the module to the down position.
9. Close the UPS output switch, input switch and BCB in turn. In split bypass configuration, it is required to close both input switches. Two minutes later, the bypass on the power flow diagram of the touchscreen starts to run, indicating the UPS is operating in bypass mode.
10. Disconnect the maintenance bypass switch, press and hold the INVERTER ON key on the operator control and display panel for two seconds to manually turn on the inverters, and the UPS transfers to normal mode.

### 10.2.3 Service Procedures Of Bypass Module

Provided that the UPS is in normal mode, and that the bypass is normal:

1. Press and hold the INVERTER OFF key on the operator control and display panel for two seconds to manually turn off the inverters, and the UPS transfers to bypass mode.
2. Close the maintenance bypass, and the UPS transfers to maintenance mode.
3. Disconnect the UPS input switch and output switch in turn. In split bypass configuration, it is required to disconnect both input switches.
4. Press the EPO button, ensure that the battery current is less than 2A. Open the BCB or disconnect the batteries.
5. Remove the fixing screws on both sides of the front panel of the bypass module, and pull the module out of the cabinet. Wait for 10 minutes before servicing the bypass module.
6. After servicing the module, push the module (at least 10s after another) into the cabinet, and tighten the screws on both sides.
7. Close the UPS output switch, input switch and BCB in turn. In split bypass configuration, it is required to close both input switches.  
Two minutes later, the bypass on the power flow diagram of the touchscreen starts to run, indicating the UPS is operating in bypass mode.
8. Open the maintenance switch, press and hold the INVERTER ON key on the operator control and display panel for two seconds to manually turn on the inverters, and the UPS transfers to normal mode.

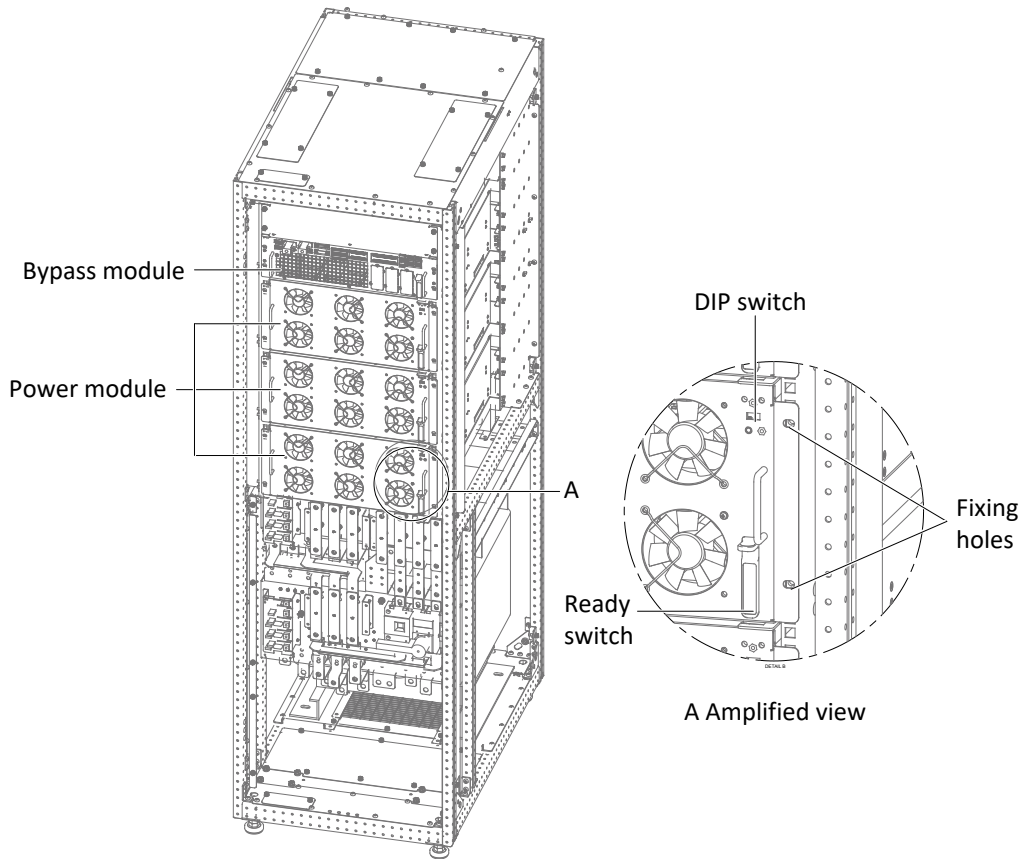

Figure 10-1 Installing power modules of 80kVA ~ 120kVA

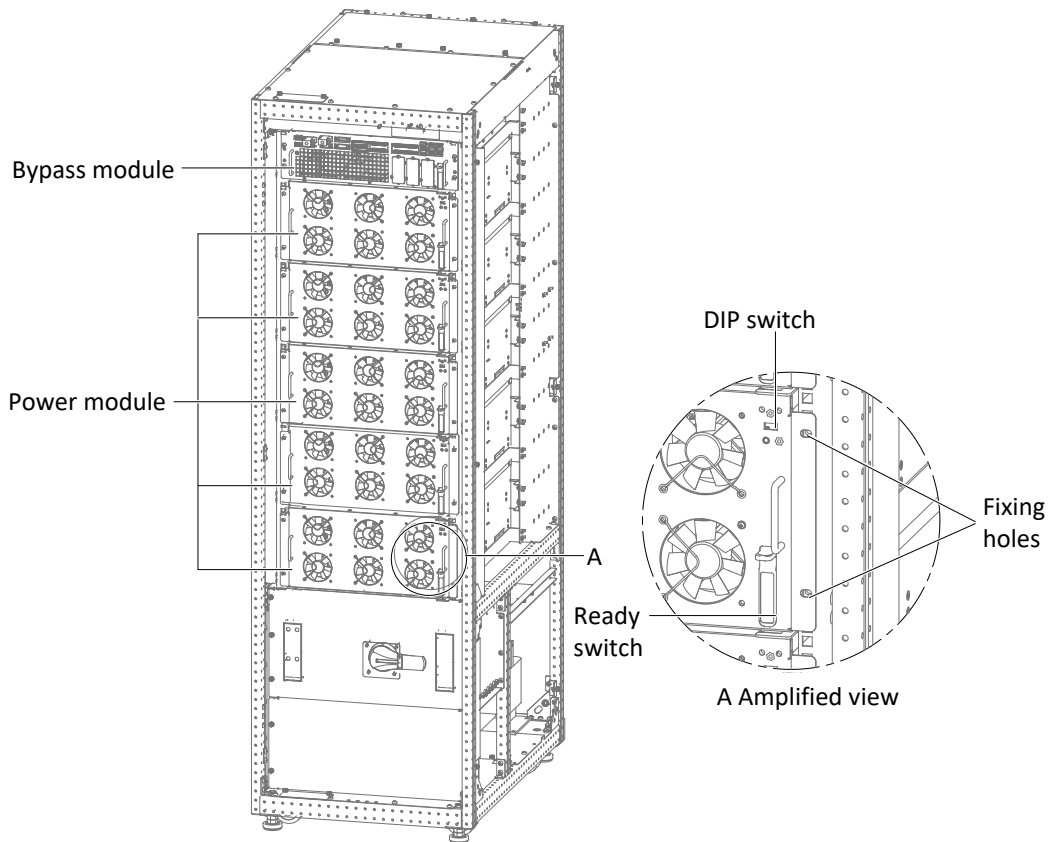



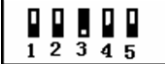



Figure 10-2 Installing power modules of 160kVA ~ 200kVA

Table 10-1 Setting method of DIP switch

DIP switch setting	Module address
	1
	2
	3
	4
	5

**Note**

Install the power modules from bottom to top to avoid cabinet toppling caused by the high center of gravity.

## 10.3 Key Components And Service Life Of UPS

When in use, some devices of UPS system will have shorter service life than UPS itself due to abrasion in work. For the safety of UPS supply system, it is necessary to have regular inspection and replacement of these devices. This section introduces the key components of UPS and the reference years of service life. For systems under different conditions (environment, load rate, and etc.), assessment and advice by professionals on whether to replace the device are required with reference to the information provided in this section.

### 10.3.1 Life Parameters And The Proposed Replacement Time Of Key Components

Key components in Table 10-2 are used in the UPS system. To prevent system failures due to some of the devices' failure by wear, it is proposed to carry out regular inspection and replacement during its estimated life.

Table 10-2 Life parameters and the proposed replacement time of key components

Key components	Estimated life	Proposed replacement time	Proposed inspection period
Fan	Not less than 7 years	Five years	One year
Bus capacitor	Not less than 7 years	six years	/
Air filter	One year to three years	One year to two years	Two months
VRLA battery (5-year life)	Five years	Three year to four years	Six months
VRLA battery (10-year life)	10 years	Six years to eight years	Six months

### 10.3.2 Replacement Of Air Filter

The air filters need regular inspection and replacement. The inspection and replacement intervals are related to the environmental conditions of the UPS. Under normal environmental conditions, the air filters should be cleaned or replaced once every two months and need more frequent cleaning and replacement in dusty or other harsh environments. Frequent inspection or replacement should also be made in new buildings.

The UPS provides air filters on the back of the front door of the cabinet, and the user can replace the air filter during the UPS operation.

Each air filter is fixed by a fixing bar on both sides. Refer to Figure 10-3, the following is the air filter replacement procedures:

1. Open the front door of the UPS to reveal the air filter on the back of the front door.
2. Remove a fixing bar on one side and loosen the fixing screws of the fixing bar on the other side, with no need to remove this fixing bar.
3. Remove the air filter to be replaced, and insert a clean one.

4. Re-install the removed fixing bar in the original place and tighten the fixing screws.
5. Tighten the fixing screws of the fixing bar on the other side.

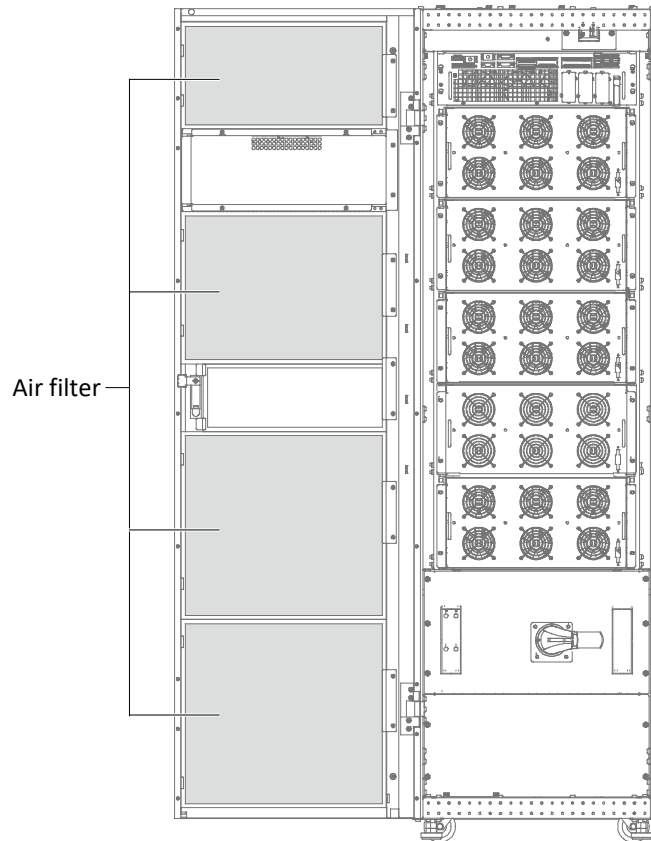

Figure 10-3 Replacing air filter

## 10.4 Maintenance Of UPS And Options

UPS and the options need common maintenance:

1. Keep good history record. Keeping good history record facilitates failure treatment.
2. Keep clean, so as to prevent UPS from the invasion of dust and moisture.
3. Maintain appropriate ambient temperature. The most appropriate temperature for battery is 20°C to 25°C. Too low temperature will reduce the battery capacity and too high temperature will reduce the battery life.
4. Check the wiring. Check the tightening of all connected screws, and there should be routine tightening at least once a year.
5. Check regularly if there is any abnormality in the superior or subordinate switch to ensure cutting off the import or export when the current is too large. Maintenance staff should be familiar with the typical ambient conditions where UPS is working in order to rapidly position which ambient conditions are unusual; the setting of UPS operation control panel should be known as well.

For information of the UPS battery maintenance, refer to 6.14 *Battery Maintenance*.

## Chapter 11 Specifications

This chapter lists the UPS specifications.

### 11.1 Conformance And Standards

The UPS has been designed to comply with the European and international standards listed in Table 11-1.

Table 11-1 European and international standards

Item	Normative reference
General safety requirements for UPS	EN62040-1/IEC62040-1/AS62040-1
EMC requirements for UPS	EN62040-2/IEC62040-2/AS62040-2 (Class C3)
Method of specifying the performance and test requirements of UPS	EN62040-3/IEC62040-3/AS62040-3 (VFI SS 111)



#### Note

The product standards in this table incorporate relevant compliance clauses with generic IEC and EN standards for safety (IEC/EN/AS60950), electromagnetic emission and immunity (IEC/EN/AS61000 series) and construction (IEC/EN/AS60146 series and 60529).

### 11.2 Environmental Characteristics

Table 11-2 Environmental characteristics

Item	Unit	Rated power (kVA)				
		80	100	120	160	200
Noise within 1m (in the front)	dB (A)	61				65
Altitude	m	≤ 1500; derate power by 1% per 100m between 1500m and 3000m				
Relative humidity	%RH	0 ~ 95%, non condensing				
Operating temperature	°C	0 ~ 40°C				
Storage and transportation temperature for UPS	°C	Storage: -25°C ~ +55°C; transportation: -40°C ~ +70°C				
Over-voltage level		Level 2				
Pollution level		Level 2				
Grid system		TN, TT, IT				

### 11.3 Mechanical Characteristics

Table 11-3 Mechanical characteristics

Item		Unit	Rated power (kVA)				
			80	100	120	160	200
Dimensions (D × W × H)	Packing excluded	mm	1000 × 600 × 2000				
	Packing included	mm	1120 × 710 × 2215				
Net weight	kg	385	430	430	475	520	
Gross weight	Kg	435	480	480	525	570	
Color		Black ZP7021					
Protection degree, IEC (60529)		IP20 (front door open or closed)					

## 11.4 Electrical Characteristics (Input Rectifier)

Table 11-4 Rectifier AC input (mains)

Item	Unit	Rated power (kVA)				
		80	100	120	160	200
Rated AC input voltage <sup>1</sup>	Vac	380/400/415, 3-phase 4-wire (+PE) TN/TT/IT power distribution system				
Input voltage range <sup>2</sup>	Vac	228 ~ 478				
Frequency <sup>2</sup>	Hz	50/60 (range: 40 ~ 70)				
Power factor	kW/kVA, full load (half load)	0.99 (0.98)				
Input current	A, rated <sup>3</sup>	122	153	183	244	305
Total current harmonic distortion	%	3				



### Note

1. Rectifiers operate at any of the rated supply voltages and frequencies without further adjustment.
2. At 305V input mains the UPS maintains the specified output voltage at rated load without discharging a battery.
3. IEC62040-3/EN50091-3: at rated load, input voltage is 400V, battery remains fully charged.

## 11.5 Electrical Characteristics (Intermediate DC Circuit)

Table 11-5 Battery

Item	Unit	Rated power (kVA)				
		80	100	120	160	200
Max. charging current	A	19.6	24.5	29.4	39.2	49
Rated battery bus voltage	Vdc	360 ~ 528				
Quantity of lead-acid cells (nominal)	Block	30 ~ 44 (12Vdc)				
Float voltage	V/cell (VRLA)	2.25 (selectable from 2.2V/cell to 2.3V/cell) Constant current and constant voltage charge mode				
Temperature compensation	mV/°C/cl	-3.0 (selectable from 0 to -5.0 around 25°C or 30°C, or inhibit)				
Ripple current	% C <sub>10</sub>	≤ 5				
Boost voltage	V/cell (VRLA)	2.35 (selectable from 2.3 to 2.35) Constant current and constant voltage charge mode				
Boost control		Float-boost current trigger 0.050C <sub>10</sub> (selectable from 0.001 to 0.070) Boost-float current trigger 0.010C <sub>10</sub> (selectable from 0.001 to 0.025) 8hr safety time timeout (selectable from 8hr to 30hr) Boost mode inhibit also selectable				
EOD voltage	V/cell (VRLA)	1.67				

## 11.6 Electrical Characteristics (Inverter Output)

Table 11-6 Inverter output (to critical load)

Item	Unit	Rated power (kVA)				
		80	100	120	160	200
Rated AC voltage <sup>1</sup>	Vac	380/400/415 (3-phase 4-wire, with neutral reference to the bypass neutral)				
Frequency <sup>2</sup>	Hz	50/60				
Power factor		1 (0<t≤30°C); 0.9 (30°C<t≤35°C); 0.8 (35°C<t≤40°C)				
Overload	%	<105%, long time; <110%, ≤1hr; <125, ≤10min; <150, ≤1min				
Max. short circuit current of inverter	A	460	690	690	920	1150
Non-linear load capability <sup>3</sup>	%	100				



Item	Unit	Rated power (kVA)				
		80	100	120	160	200
Steady state voltage stability	%	±1				
Transient voltage response	%	±5				
Total voltage harmonic distortion	%	< 1 (linear load), < 3 (non-linear load <sup>3</sup> )				
Synchronisation window	Hz	Rated frequency ±2Hz (Range: 50/60Hz ± 10%)				
Slew rate (max. change rate of synchronisation frequency)	Hz/s	0.6; setting range: 0.1 ~ 3				

**Note**

1. Factory set to 380V. 400V or 415V can be selected by service engineer at site.
2. Factory set to 50Hz. 60Hz can be selected by service engineer at site. Note that the system frequency can be changed only when the UPS is on bypass. It is strictly prohibited to change the system frequency when the UPS is on inverter.
3. EN 50091-3 (1.4.58) crest factor 3:1, non-linear load.

## 11.7 Electrical Characteristics (Bypass Input)

Table 11-7 Bypass input

Item	Unit	Rated power (kVA)					
		80	100	120	160	200	
Rated AC voltage <sup>1</sup>	Vac	380/400/415, 3-phase 4-wire, sharing neutral with the rectifier input and providing neutral reference to the output					
Rated current	380V	A	121	151	181	242	302
	400V	A	116	145	174	232	290
	415V	A	111	139	166	222	278
Frequency <sup>2</sup>	Hz	50/60					
Bypass voltage tolerance	%Vac	Upper limit: +10, +15 or +20, default: +15 Lower limit: -10, -20, -30 or -40, default: -20 (delay time to accept steady bypass voltage: 10s)					
Bypass frequency tolerance	%	±10 or ±20, default: ±10					

**Note**

1. Factory set to 380V. 400V or 415V can be selected by service engineer at site.
2. Factory set to 50Hz. 60Hz can be selected by service engineer at site.

## 11.8 Efficiency And Loss

Table 11-8 Efficiency and loss

Item	Unit	Rated power (kVA)				
		80	100	120	160	200
Rated normal mode	kW	4	5	6	8	10
ECO mode	kW	1.2	1.2	1.2	2	2

## Appendix 1 Glossary

AC	Alternating current
BCB	Battery circuit breaker
CSA	Cross sectional area
DC	Direct current
EIB	External interface board
EMC	Electromagnetic compatibility
EMI	Electromagnetic interference
EOD	End-of-discharge
EPO	Emergency power off
I/O	Input/output
IGBT	Integrated gate bipolar transistor
LBS	Load bus synchronizer
TOUCHSCREEN	Liquid crystal display
LED	Light-emitting diode
MCCB	Moulded-case circuit breaker
PC	Personal computer
PE	Protective earth
RCCB	Residual current circuit breaker
RCD	Residual current detector
REPO	Remote emergency power off
SCR	Silicon-controlled rectifier
SNMP	Simple network monitoring protocol
STS	Static transfer switch
SVPWM	Space vector pulse width modulation
UPS	Uninterruptible power system
VRLA	Valve-regulated lead-acid

## Appendix 2 Hazardous Substances And Content

Parts	Hazardous substances					
	Plumbum	Hydrargyru	Cadmium	Chrome <sup>6+</sup>	PBB	PBDE
	(Pb)	(Hg)	(Cd)	(Cr (VI))	(PBB)	(PBDE)
Hex copper stud	×	○	○	○	○	○
PCBA	×	○	○	○	○	○
AC capacitor	×	○	○	○	○	○
DC capacitor	×	○	○	○	○	○
Fan	×	○	○	○	○	○
Cables	×	○	○	○	○	○
TOUCHSCREEN	×	×	○	○	○	○
Sensors	×	○	○	○	○	○
Large-medium power magnetic components	×	○	○	○	○	○
Circuit breaker/rotating switch	×	○	○	○	○	○
Semiconductors	×	○	○	○	○	○
Battery (when applicable)	×	○	○	○	○	○
Insulation monitoring device (when applicable)	×	○	○	○	○	×
This table is made following the regulation of SJ/T 11364.						
○: Means the content of the hazardous substances in all the average quality materials of the parts is within the limits specified in GB/T 26572						
×: Means the content of the hazardous substances in at least one of the average quality materials of the parts is outside the limits specified in GB/T 26572						
About battery: Generally follow the environmental protection use period of the battery, otherwise five years.						
Applicable scope: Liebert EXM UPS Single And Parallel System 80kVA ~ 200kVA UPS						