



Liebert[®] iCOM[™]

Installer/User Guide

**Intelligent Communication and Monitoring for Liebert[®] Mini-Mate
Variable Capacity 3 Ton, 4 Ton, and 5 Ton**

The information contained in this document is subject to change without notice and may not be suitable for all applications. While every precaution has been taken to ensure the accuracy and completeness of this document, Vertiv assumes no responsibility and disclaims all liability for damages resulting from use of this information or for any errors or omissions.

Refer to local regulations and building codes relating to the application, installation, and operation of this product. The consulting engineer, installer, and/or end user is responsible for compliance with all applicable laws and regulations relating to the application, installation, and operation of this product.

The products covered by this instruction manual are manufactured and/or sold by Vertiv. This document is the property of Vertiv and contains confidential and proprietary information owned by Vertiv. Any copying, use, or disclosure of it without the written permission of Vertiv is strictly prohibited.

Names of companies and products are trademarks or registered trademarks of the respective companies. Any questions regarding usage of trademark names should be directed to the original manufacturer.

Technical Support Site

If you encounter any installation or operational issues with your product, check the pertinent section of this manual to see if the issue can be resolved by following outlined procedures.

Visit <https://www.vertiv.com/en-us/support/> for additional assistance.

TABLE OF CONTENTS

1 Getting Started with Vertiv™ Liebert® iCOM™	1
1.1 Touchscreen Display and User Interface	1
1.2 Touchscreen Status Dial	3
1.2.1 Dial Background Color Status Indication	5
1.3 Control Header	6
1.3.1 Powering On the Vertiv™ Liebert® iCOM™ and Logging In/Unlocking Controls	6
1.3.2 Powering On the Thermal Management Unit	7
1.3.3 Powering Off the Thermal Management Unit	8
1.3.4 Logging Out	8
1.3.5 Calibrating the Touchscreen	8
1.3.6 Setting the Date and Time	9
1.3.7 Searching	9
1.4 Using Context Sensitive Help	9
1.5 About Vertiv™ Liebert® iCOM™ Version	10
1.6 Accessing the User, Service, and Advanced Menus	10
1.7 User Menu	10
1.7.1 User Menu Options	10
1.8 Service Menu	11
1.8.1 Service Menu Options	11
1.9 Advanced Menu	12
1.9.1 Advanced Menu Options	12
2 User Operation	15
2.1 Viewing and Editing Setpoints for the Cooling Unit	15
2.1.1 Editing Humidity Setpoints	15
2.1.2 Editing Temperature Setpoints	16
2.2 Viewing Unit Alarms	16
2.2.1 To View Alarms	17
2.2.2 Silencing an Audible Alarm	18
2.2.3 Acknowledging Alarms	18
2.3 Viewing the Event Log	19
2.4 Viewing Sensor Data	20
2.5 Managing Run Hours for a Component	20
2.5.1 Setting Run Hours to Zero	20
2.6 Viewing Teamwork, Standby, and Cascade Status	21
2.6.1 To View Teamwork Details	21
3 Service Operation	23
3.1 Editing Setpoints for the Cooling Unit	23
3.1.1 Setpoints Options	23

3.1.2	Configuring Temperature Setpoints	23
3.1.3	Temperature Control—Temperature Setpoints and Cooling Operation	26
3.1.4	Compressor Control by Cooling Requirement	28
3.1.5	Setting Temperature Compensation	30
3.1.6	Configuring High and Low Limit Setpoints	31
3.1.7	Configuring Humidity Setpoints	32
3.1.8	Humidity Control	33
3.1.9	Configuring Fan Setpoints	36
3.1.10	Manual Fan Speed Control	37
3.1.11	Automatic Fan Speed Control	38
3.1.12	Scheduling Sleep Times for Thermal Management Units	39
3.2	Setting General Thermal Management Unit Options	40
3.2.1	Setting Miscellaneous Options	40
3.2.2	Configuring Quick Start	42
3.2.3	Automatic Restart after Power Failure	43
3.2.4	Setting Fan Options	43
3.2.5	Setting Compressor Options	45
3.2.6	Setting Reheat Options	46
3.2.7	Reheat Control	47
3.2.8	Setting Humidifier Options	50
3.2.9	Setting Dehumidification Options	50
3.2.10	Setting Q15 Options	51
4	Managing Events: Alarms, Warnings and Messages	53
4.1	Event Properties	53
4.1.1	To Open the Panel	53
4.2	Enabling Events and Editing Event Settings	54
4.3	Selecting Event Type and Setting Alarm/Warning Notification	55
4.3.1	To Select Event Type and Notification	55
4.4	Enabling the Audible Alarm Notification	59
4.5	Remote Alarm Device and Customer Input Events	59
4.5.1	Setting Up Customer Input Events	59
5	Unit to Unit (U2U) Networking	63
5.1	Preparing for U2U Group Set Up	63
5.2	Configuring U2U Network Settings	64
5.2.1	To Configure U2U Networking	64
5.2.2	Troubleshooting Network Settings Issues	66
5.2.3	Modifying U2U Network Settings	66
6	Teamwork, Standby, and Rotation for Cooling Units	67
6.1	Continuous Control with Virtual Master	67
6.2	Teamwork Modes	67

6.2.1 To Set Up Team Work	67
6.2.2 No Teamwork—Multiple Zones in One Room	69
6.2.3 Teamwork Mode 1—Parallel Operation	69
6.2.4 Teamwork Mode 2—Independent Operation	70
6.3 Assigning Cooling Units to Standby (Lead/Lag)	70
6.3.1 To Set Up Lead/Lag Operation	70
6.4 Setting a Rotation Schedule	71
6.4.1 Unit Rotation Options	71
6.4.2 Manually Rotating the Operating and Standby Units	72
7 External Monitoring and Building Management Systems	73
7.1 BMS and IntelliSlot Settings	73
7.1.1 Configuring BMS Communication with Embedded Unity	73
7.1.2 Setting BMS Control Settings	74
7.1.3 Setting BMS Backup Setpoints	75
7.2 Communication Set Up with Embedded Unity	75
7.2.1 Connecting to the BMS	76
7.2.2 Embedded Unity User and Password	80
7.2.3 Unity Restart and Restore Defaults	81
7.2.4 System Configuration	81
7.2.5 Local Users Configuration	83
7.2.6 Network Configuration	84
7.2.7 Web Server Configuration	87
7.2.8 Remote Services Configuration	89
7.2.9 Remote Services Connectivity	90
7.2.10 Velocity Protocol Configuration	91
7.2.11 Messaging Configuration	93
7.2.12 E-Mail Messaging Configuration	93
7.2.13 SMS Messaging Configuration	95
7.2.14 BACnet Protocol Set Up	97
7.2.15 Modbus Protocol Set Up	100
7.2.16 SNMP Protocol Setup	102
7.3 Unity Status Readings	107
7.4 Unity Support Information	107
7.4.1 Support Folder Settings	107
7.4.2 Configuring Active Networking Settings	109
8 Configuring Auxiliary Devices	111
8.1 Configuring Analog Input Devices	111
8.2 Wired Remote Sensors	112
8.2.1 Wired Remote Sensor Setup Options	112
8.2.2 Wired Remote Sensor—Sensor Property Options	113

9 Administering Firmware, Settings and Security	115
9.1 Vertiv™ Liebert® iCOM™ Firmware Upgrades	115
9.1.1 Compatibility with Earlier Versions of Liebert® iCOM™	115
9.1.2 Updating Liebert® iCOM™ Control Board Firmware	115
9.1.3 Control Board Firmware Upgrade Options	116
9.2 Backing Up and Restoring Control Board Settings	117
9.2.1 Control Board Backup and Restore Options	117
9.3 Managing Access Permission and Passwords	118
10 Performing Diagnostics	119
10.1 Cooling Unit Status LED	119
10.2 Enabling Manual Mode for Diagnostics	119
10.2.1 Disabling Diagnostics Manual Mode	120
10.3 Diagnosing Evaporator Fan Issues	120
10.3.1 Diagnostics—Evaporator Fan Options	120
10.4 Diagnosing Compressor Circuit Issues	121
10.4.1 Diagnostics—Compressor Circuit Options	121
10.4.2 Resetting High Pressure Alarm Code	122
10.4.3 Resetting Low Pressure Alarm Code	123
10.4.4 Resetting High Temperature Alarm Counter	123
10.5 Diagnosing Reheat Issues	123
10.5.1 Diagnostics—Reheat Options	123
10.6 Diagnosing Humidifier Issues	124
10.6.1 Diagnostics—Humidifier Options	124
10.7 Diagnosing Digital Output Issues	125
10.7.1 Diagnostics—Digital Output Options	125
10.8 Diagnosing Analog Output Issues	125
10.8.1 Diagnostics—Analog Output Options	125
10.9 Diagnosing Customer Input Issues	126
10.9.1 Diagnostics—Customer Input Options	126
11 Customizing Your Vertiv™ Liebert® iCOM™ Display	127
11.1 Setting General Display Properties	127
11.1.1 Unit Display Options	127
11.2 Customizing Main Display Views	128
11.2.1 Moving Content	128
11.2.2 Resizing Content	128
11.2.3 Adding and Adjusting Content	129
11.2.4 Removing Content	130
11.3 Customizing Parameter and Field Labels	130
11.3.1 Exporting, Importing and Customizing Labels Using a Text Editor	132
12 Vertiv™ Liebert® iCOM™ Hardware Installation	135

- 12.1 Return Air Temperature/Humidity Sensor 135
 - 12.1.1 P67: Return Air Temperature—Humidity Board 136
 - 12.1.2 Jumper P3 CANbus Termination 138
- 12.2 Installing the U2U Network 138
 - 12.2.1 Required Network Equipment 138
 - 12.2.2 Planning Wiring Runs 138
 - 12.2.3 U2U Wiring Connections 139
 - 12.2.4 Wiring Cooling Units without Wall Mount Displays 140
 - 12.2.5 Wiring Cooling Units with Wall Mount Displays 142
- Appendices 143**
- Appendix A: Technical Support and Contacts 143
- Appendix B: Setpoints and Alarm Settings by Line ID 145

This page intentionally left blank

1 Getting Started with Vertiv™ Liebert® iCOM™

The Liebert® iCOM™ offers the highest capability for unit control, communication, and monitoring of Liebert Thermal Management units. It is available factory installed on new units and assemblies or may be retrofitted in existing units.

1.1 Touchscreen Display and User Interface

The Liebert® iCOM™ touchscreen and user interface speeds set up and installation and simplifies control of Liebert thermal management units, literally putting cooling system monitoring and management at your fingertips.

- User and service menus are password protected to prevent unauthorized changes to cooling unit operation.
- The touchscreen is back lit and auto-dims after a period of non-use, then turns off. Touch the screen to illuminate the main screen.
- Liebert® iCOM™ ships with default settings for efficient and effective operation of most cooling units and is easily configured to meet any need.
- Liebert® iCOM™ menus and displays are based on the options installed on the cooling units that it monitors and manages.

Figure 1.1 Vertiv™ Liebert® iCOM™ Main Display

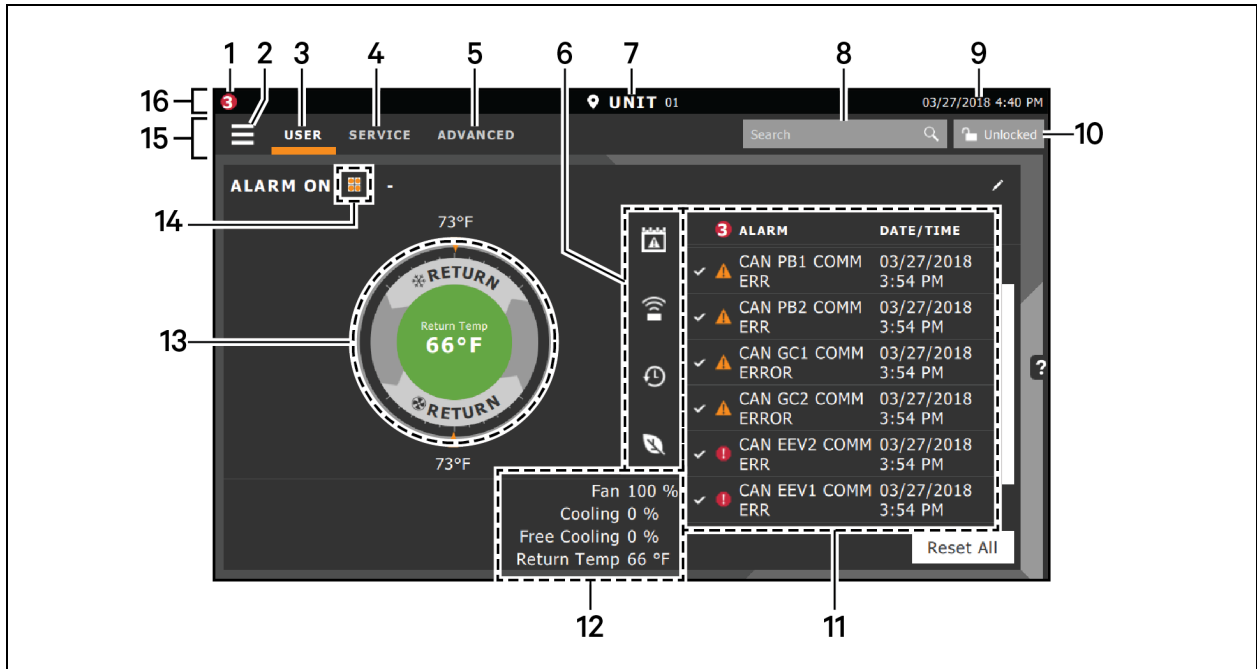

Table 1.1 Main Display Controls and Options

Item	Description
1	Alarms present. Displays the number of active alarms.
2	Menu icon. When unlocked, displays a menu for user or service options depending on which icon is selected.
3	User icon. When selected, the user options are available on the main display and menu. NOTE: You must unlock the display with the User PIN to access the menu and options. See Powering On the Vertiv™ Liebert® iCOM™ and Logging In/Unlocking Controls on page 6 .
4	Service icon. When selected, the service options are available on the main display and menu. NOTE: You must unlock the display with the Service PIN to access the menu and options. See Powering On the Vertiv™ Liebert® iCOM™ and Logging In/Unlocking Controls on page 6 .
5	Advanced icon. When selected, the advanced options are available on the main display and menu. NOTE: You must unlock the display with the Service PIN to access the menu and read-only options. See Powering On the Vertiv™ Liebert® iCOM™ and Logging In/Unlocking Controls on page 6 .
6	Cooling unit parameters. Status display of selected system parameter settings. See Adding and Adjusting Content on page 129
7	Unit Identification. You may customize the unit name up to six characters/numbers.
8	Search icon. Open the keyboard to search for controls and setting locations. See Searching on page 9 .
9	Date/Time.
10	Lock/Unlock icon. Indicates whether or not the user and service options are accessible. <ul style="list-style-type: none"> Locked icon: Display is read-only Unlocked icon: User or service is logged in and options are accessible. See Powering On the Vertiv™ Liebert® iCOM™ and Logging In/Unlocking Controls on page 6 .

Table 1.1 Main Display Controls and Options (continued)

Item	Description
11	Secondary content panel. When accessing settings/configuration via the menus, the settings display in the right, secondary panel.
12	Summary of current unit function. You can customize to show fan speed, cooling, percentages from any installed device, and any physical (sensor) values.
13	Status Dial. Circular display of setpoints and environmental conditions of the unit. See Touchscreen Status Dial below .
14	Teamwork mode icon. In a panel with Status content, the Teamwork Mode icon indicates the mode selected. For details and descriptions of the teamwork controls, see Teamwork Modes on page 67 .
15	Control header. Controls to access the user and service menus. See Control Header on page 6 .
16	Status Header. Displays the alarm status, unit identification, and the current date and time.

1.2 Touchscreen Status Dial

The dial in the primary control panel displays read-only control sensors, setpoints, and environmental conditions for unit status at a glance. See [Figure 1.2](#) on the next page .

The center of the dial displays sensor readings and changes color according to alarm thresholds as the readings rise and fall, see [Dial Background Color Status Indication](#) on page 5 .

Touching the center of the dial cycles through a set of sensor settings, and you can select the readings displayed, see [Adding and Adjusting Content](#) on page 129 .

Figure 1.2 Dial Sections

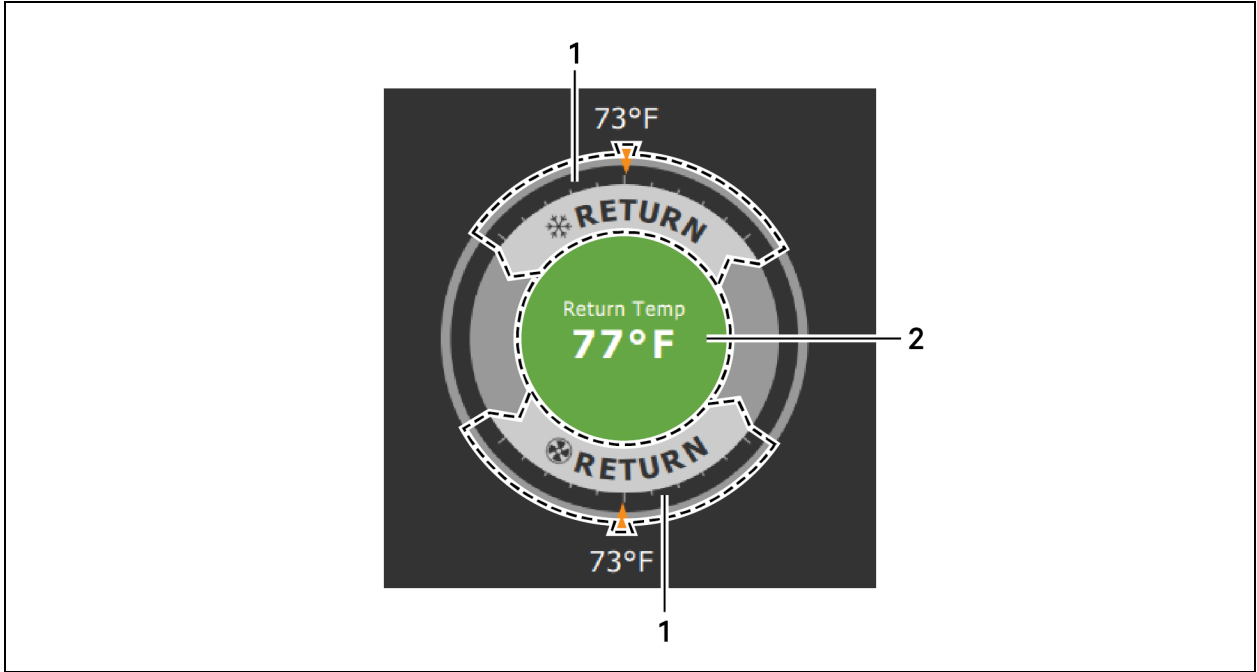

Table 1.2 Dial Sections

Item	Description
1	Control sensor and its setpoint. The sensors and setpoints displayed depend on the configuration of your unit. You may see only temperature control, or if the unit includes humidity control, that displays on the dial as well. If the sensor selected for fan control is the same as that selected for temperature control, the dial displays the fan control sensor and setpoint, as shown in Figure 1.2 above.
2	Single or multiple sensor readings. Cycle through readings by touching the displayed reading.

1.2.1 Dial Background Color Status Indication

The background color of the dial indicates whether or not the unit is powered on and it also responds to threshold settings of the control sensor reading. **Figure 1.3** below and **Table 1.3** below describe the background color displayed if the selected sensor reading has threshold limits set.

Figure 1.3 Dial Background Colors

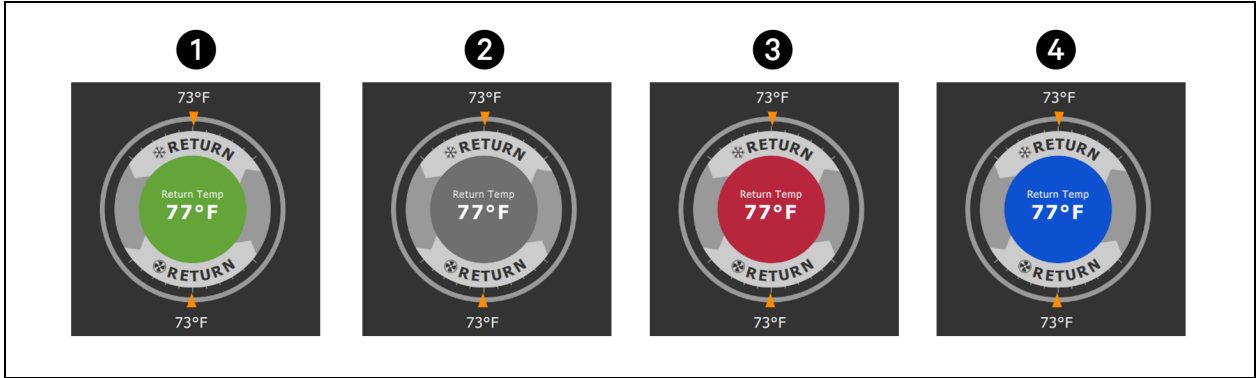

Item	Description
1	Sensor reading is within threshold limits.
2	Unit is powered off.
3	Sensor reading is above threshold limit or the unit is in an alarm condition.
4	Sensor reading is below threshold limit

Table 1.3 Background Color Displayed by Selected Value and Threshold Limit

Sensor/Value Selected	Threshold Limit	Background Color
Return Temp	None	Green
	High return temperature	Red
Return Humidity	Low return humidity	Blue
	High return humidity	Red
Dew Point	Low dew point	Blue
	High dew point	Red
Average Rack Temp	Low remote temperature	Blue
	High remote temperature	Red
Max Rack Temp	Low remote temperature	Blue
	High remote temperature	Red
Min Rack Temp	Low remote temperature	Blue
	High remote temperature	Red

Table 1.3 Background Color Displayed by Selected Value and Threshold Limit (continued)

Sensor/Value Selected	Threshold Limit	Background Color
Static Pressure	Low static pressure	Blue
	High static pressure	Red
Outdoor Temp	None	Green
Outdoor Humidity	None	Green

1.3 Control Header

The control header contains the controls to access the user and service settings. The display is locked when started initially and when restarted after a period of inactivity.

1.3.1 Powering On the Vertiv™ Liebert® iCOM™ and Logging In/Unlocking Controls

Liebert® iCOM™ is powered on when power is switched on at the cooling unit’s disconnect switch and you activate the display by touching it.



Liebert® iCOM™ is locked when started and also locks after a period of inactivity to prevent unauthorized changes. A four-digit password is required to access the user and service menus and options, and the advance menu displays as read-only when logged in at the service level.

NOTE: The factory default inactivity period is one minute. To change the inactivity period, see [Setting General Display Properties](#) on page 127 .

NOTE: The factory default password for user and service log in are provided. We recommend you change passwords as necessary to prevent unauthorized changes. See [Managing Access Permission and Passwords](#) on page 118 .

- Default user password: 1490
- Default service password: 5010

To Unlock the Controls

1. On the header, touch . The keypad opens.
2. Touch the numbers/characters for your password, then touch . Depending on the password entered and your level of access, the User and/or Service options, and view-only access to the Advanced menu are accessible. See [Accessing the User, Service, and Advanced Menus](#) on page 10 .

1.3.2 Powering On the Thermal Management Unit

NOTE: Depending on the operating state, there are start/stop priority switches that may prevent the cooling unit from operating even though power to the unit is switched on and you have turned it on via Vertiv™ Liebert® iCOM™.

The cooling unit operates only when all switches are closed. For example, even though you have turned on the unit through Liebert® iCOM™, if the BMS remote monitoring system is sending a command to turn off the unit, the cooling unit remains off.

NOTE: You must be logged in to access the menu options. See [Powering On the Vertiv™ Liebert® iCOM™](#) and [Logging In/Unlocking Controls](#) on the previous page .

To Power On the Unit



1. Touch , then  > *Turn Unit On*. The TURN UNIT ON dialog opens.
2. Touch *Turn Unit On*. The cooling unit starts and the operating status is displayed as shown in [Figure 1.4](#) below .

Figure 1.4 Unit Status on Vertiv™ Liebert® iCOM™ Display



Item	Description
1	Current status of the unit. See Cooling Unit Statuses Displayed below .
2	Teamwork icon. See Viewing Teamwork, Standby, and Cascade Status on page 21 .

Table 1.4 Cooling Unit Statuses Displayed

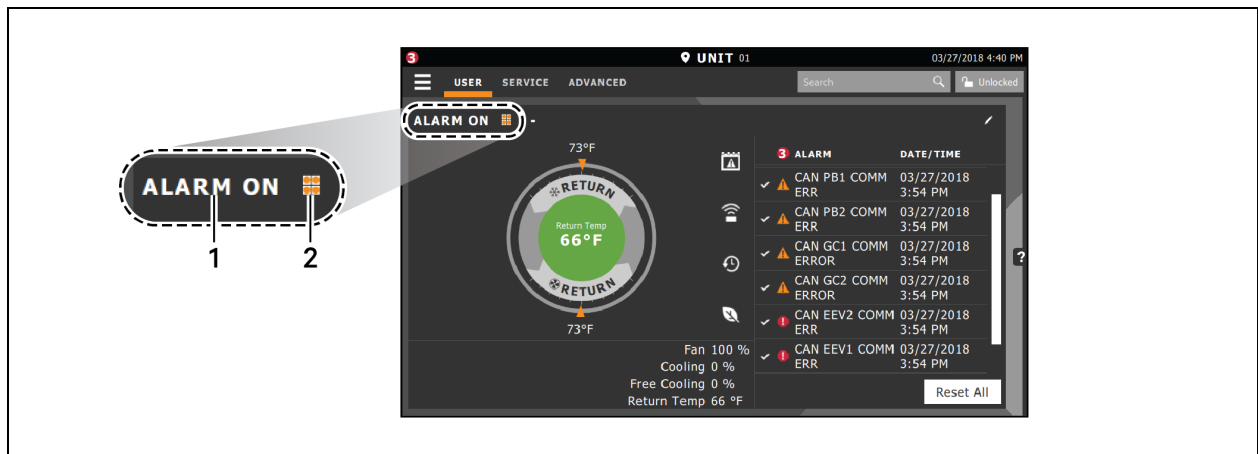

Unit Status Text	Description
ALARM OFF	An alarm forced the unit to turn off. See Viewing Unit Alarms on page 16 .
MANUAL	Controlled by a service technician. See Enabling Manual Mode for Diagnostics on page 119 .
DISPLAY OFF	Unit is turned Off at the Liebert® iCOM™ display. See Powering On the Thermal Management Unit above
ALARM STANDBY	In standby because of an active alarm on the unit. See Viewing Unit Alarms on page 16 .

Table 1.4 Cooling Unit Statuses Displayed (continued)

Unit Status Text	Description
STANDBY	In standby because of service menu setting. See Assigning Cooling Units to Standby (Lead/Lag) on page 70 .
UNIT ON	Operating normally without alarms or warnings.
WARNING ON	Active warning, but still operating. See Viewing Unit Alarms on page 16 .
ALARM ON	Active alarm, but still operating. See Viewing Unit Alarms on page 16 .
REMOTE OFF	Turned off by remote shutdown terminal. Occurs when a normally closed set of 24 V contacts opens. The Remote On/Off and Display On/Off switches are in series, and the cooling unit will only turn on if both switches are on/closed. If one is off/open, the unit turns off.
MONITORING OFF	Turned off by remote monitoring system. Check the remote monitoring device or call Vertiv™ technical support for assistance.
BACK-DRAFT	Unit is non-operational, but EC fan is operating as a back draft damper.
RESTART DELAY	Not yet operational after a power cycle because the restart delay timer is active.

1.3.3 Powering Off the Thermal Management Unit

NOTE: You must be logged in to access the menu options. See [Powering On the Vertiv™ Liebert® iCOM™ and Logging In/Unlocking Controls](#) on page 6 .

1. Touch , then  > *Turn Unit Off*. The TURN UNIT OFF panel opens.
2. Touch *Turn Unit Off*. The unit begins a power off countdown then powers off.

1.3.4 Logging Out

Log out occurs automatically when the display back light turns off for inactivity.

NOTE: The factory default inactivity period is one minute. To change the inactivity period, see [Setting General Display Properties](#) on page 127

- To log out manually, touch the lock icon. The icon indicates LOCKED.

1.3.5 Calibrating the Touchscreen



Use a firm touch or a stylus for the best response. To improve interaction with quicker and more accurate touch response, calibrate the touchscreen.

1. On the User menu, touch *Display Options* > *Display Properties*.
2. On the UNIT DISPLAY panel, touch *Calibrate Screen* and follow the prompts to calibrate.
 - If you cannot access the calibration because of screen response, continue with step 3 .
3. At the cooling unit disconnect switch, power off the unit and then back on.
4. Touch your finger to the screen and hold it there while the display boots.

5. When the LED begins flashing, remove your finger.
Cross hairs appear in each corner and in the center of the display.
6. Touch the center of each cross hair ONCE ONLY. (Touching more than once interrupts the calibration and you must start over at step 3.)
Cross hairs disappear and the display reboots when calibration is complete.

1.3.6 Setting the Date and Time

The correct date and time is critical for warnings, alarms, and scheduling.

1. Touch , then  > *Display Options* > *Display Properties* > *Date & Time*.
2. Touch the date field, use the arrows to select the date, and touch *OK*.
– or –
Touch the time field, use the arrows to set the time, and touch *OK*.
3. Select the date and time format if necessary.
4. Touch *Save*.

1.3.7 Searching

When logged in, you can use the display search to find the location of settings options based on a term, service code, or parameter. You can also search by the line ID used in the Vertiv™ Liebert® iCOM™ before the touchscreen model. For a listing of the line IDs, see [Setpoints and Alarm Settings by Line ID](#) on page 145.

NOTE: You must be logged in to access the display search. See [Powering On the Vertiv™ Liebert® iCOM™ and Logging In/Unlocking Controls](#) on page 6.

1. In the control header, touch the search field. The keyboard opens.
2. Type the term and touch . A list of locations that contain the searched term opens.
3. To go to a listed location, touch an item, then touch *Go*. The panel for the selected location opens.

– or –

To view the service codes and parameter entries related to the searched term, touch *View Parameter Directory Entries* (the number of related entries is included in the option).

The Parameter Directory opens. You may further refine the search in the directory.

1.4 Using Context Sensitive Help

Touching the Help icon,  on the right-hand side of the display opens the Help drawer with information about the panel or dialog currently on the display.

You can use search and the topic index to find further information.

To close the Help drawer, touch the close arrow, .

1.5 About Vertiv™ Liebert® iCOM™ Version



The version, build, and other firmware information for the Liebert® iCOM™ display board may be helpful when servicing or troubleshooting. To locate the firmware version of the Liebert® iCOM™ control board, see [Updating Liebert® iCOM™ Control Board Firmware](#) on page 115 .

- Touch , then  > *About*. The ABOUT panel opens.

1.6 Accessing the User, Service, and Advanced Menus

Liebert® iCOM™ operating functions that monitor and control a cooling unit are accessed via the User and Service menus.

NOTE: You must be logged in to access the menu options. See [Powering On the Vertiv™ Liebert® iCOM™ and Logging In/Unlocking Controls](#) on page 6 .

1. To access a menu, touch the icon for the menu you want, , , or , in the control header, see [Control Header](#) on page 6 .

The orange bar appears below the menu name when selected indicating that this is the menu content that will be displayed.

2. Touch the menu icon, . The menu opens.

1.7 User Menu

The user menu lets you view system and unit statuses and edit some setpoints.

1.7.1 User Menu Options

Setpoints

Opens the SETPOINTS panel. See [Viewing and Editing Setpoints for the Cooling Unit](#) on page 15 .

Active Alarms

Opens the ALARMS panel. See [Viewing Unit Alarms](#) on page 16 .

Event Log

Opens the EVENT LOG panel. See [Viewing the Event Log](#) on page 19 .

Sensor Data

Opens the SENSOR DATA panel. See [Viewing Sensor Data](#) on page 20 .

Display Options

Opens the Display Options menu:

- Customize Layout: See [Customizing Main Display Views](#) on page 128 .
- Custom Label: See [Customizing Parameter and Field Labels](#) on page 130 .
- Date & Time: See [Setting the Date and Time](#) on page 9 .

Total Run Hours

Opens the RUN HOURS panel. See [Managing Run Hours for a Component](#) on page 20 .

About

Opens the ABOUT panel. See [About Vertiv™ Liebert® iCOM™ Version](#) on the previous page .

Turn Unit On/Off

Depending on unit's status, open the TURN UNIT ON or TURN UNIT OFF dialog. See [Powering On the Thermal Management Unit](#) on page 7 , or [Powering Off the Thermal Management Unit](#) on page 8 .

1.8 Service Menu

The service menu lets you view and edit setpoints and perform many other functions.

1.8.1 Service Menu Options

Setpoints

Opens the SETPOINTS panel. See [Editing Setpoints for the Cooling Unit](#) on page 23 .

Diagnostic/Service

Opens the Diagnostic/Service menu:

- Diagnostics: See [Performing Diagnostics](#) on page 119 .
- Technical Support: Contact information for the cooling unit and Vertiv™Liebert® iCOM™ display.

Alarm/Event Setup

Opens the ALARMS & EVENTS panel. See [Managing Events: Alarms, Warnings and Messages](#) on page 53 .

BMS & Teamwork

Opens the BMS & Teamwork menu:

- U2U Setup: See [Configuring U2U Network Settings](#) on page 64 .
- Teamwork/Standby: See [Teamwork, Standby, and Rotation for Cooling Units](#) on page 67
- BMS Setup: See [BMS and IntelliSlot Settings](#) on page 73 .
- IS-Unity Setup: See [Communication Set Up with Embedded Unity](#) on page 75 .
- IS-Unity Settings: Restarts IS-Unity functions, see [Communication Set Up with Embedded Unity](#) on page 75 .

Options Setup

Opens the OPTIONS SETUP panel. See [Setting General Thermal Management Unit Options](#) on page 40 .

Auxiliary Device Setup

Opens the Auxiliary Device Setup menu:

- Sensors—See [Wired Remote Sensors](#) on page 112 .
- Analog Input—See [Configuring Analog Input Devices](#) on page 111 .
- Modbus Devices
- CapCom

Backup & Security

Opens the Backup & Security menu:

- Backup and Restore. See [Backing Up and Restoring Control Board Settings](#) on page 117 .
- Load Firmware. See [Vertiv™ Liebert® iCOM™ Firmware Upgrades](#) on page 115 .
- Manage Permissions. See [Managing Access Permission and Passwords](#) on page 118 .

Turn Unit On/Off

Depending on unit's status, open the TURN UNIT ON or TURN UNIT OFF dialog. See [Powering On the Thermal Management Unit](#) on page 7 , or [Powering Off the Thermal Management Unit](#) on page 8 .

1.9 Advanced Menu

The advanced menu provides a read-only view of the advanced set up and factory level settings.

1.9.1 Advanced Menu Options

Factory Settings

Unit code and configuration settings.

Diagnostics

Details about control and cooling operation.

Expert Settings

Parameters and settings for use by trained professionals only.

Compressor Info

Details about compressor state and operating mode.

Tandem Info

Details about tandem compressor states and operating modes.

MBV Settings

Motorized ball valve settings (water cooled heat rejection).

Runtime Monitoring

Details about component run times.

Modbus Devices

Information about connected Modbus devices such as power and flow meters.

Control Override

Allows simulating events and override of analog outputs beyond normal limits.

EEV Settings

Electronic expansion valve settings.

EconoPhase

Details about EconoPhase pumping unit.

MC Condenser

Details about MC condenser (air cooled heat rejection).

Parameter Directory

A searchable list of all parameters in the user interface. See [Setpoints and Alarm Settings by Line ID](#) on page 145.

This page intentionally left blank



2 User Operation

2.1 Viewing and Editing Setpoints for the Cooling Unit

NOTE: User level access allows viewing and editing only a limited number of setpoints. To view or adjust all setpoints, you must have service level access. See [Editing Setpoints for the Cooling Unit](#) on page 23 .

NOTE: Depending on the type of thermal management unit, included components, and control settings of your system, all of the options listed may not be available on your Vertiv™ Liebert® iCOM™ display.

2.1.1 Editing Humidity Setpoints

1. Touch  , then  >Setpoints. > Humidity Control. The HUMIDITY CONTROL secondary panel opens.
2. Refer to the [User Humidity Setpoint Options](#) below and [Humidity Control](#) on page 33 to adjust the setpoint options, then touch Save. The setpoint is updated.
 - Touch *Cancel* to discard the changes.

NOTE: Depending on the type of thermal management unit, included components, and control settings of your system, all of the options listed may not be available on your Vertiv™ Liebert® iCOM™ display.

User Humidity Setpoint Options

Dew Point Setpoint

Desired dew point (based on actual return air temperature and humidity) by adding moisture to or removing moisture from the air.

Humidity Control Sensor

Selects sensor used when calculating relative humidity.

Humidity Control Type



Control when staging humidification operations. Valid values are:

- Relative. Percent of humidification/dehumidification is determined by the difference between the humidity sensor reading and the humidity setpoint.
- Compensated. Percent of humidification/dehumidification is determined by considering the actual deviation from the temperature setpoint and adjusts the humidity setpoint accordingly. The recalculated humidity setpoint displays on the screen.
- Predictive. Percent of humidification/dehumidification is determined by considering the actual deviation from the temperature setpoint and adjusts the humidity sensor reading accordingly. The adjusted humidity sensor reading displays on the screen.
- Dewpoint. Percent of humidification/dehumidification is determined by the difference between the dew point calculated from the humidity sensor reading and the dew point setpoint.

Humidity Setpoint

Desired humidity level by adding moisture to or removing moisture from the air.

2.1.2 Editing Temperature Setpoints

1. Touch , then  > *Setpoints* > *Temperature Control*. The TEMPERATURE CONTROL secondary panel opens.
2. Refer to [User Temperature Setpoint Options](#) below, [Temperature Control—Temperature Setpoints and Cooling Operation](#) on page 26, and [Compressor Control by Cooling Requirement](#) on page 28 to adjust the setpoint options, then touch *Save*.
The setpoint is updated.
 - Touch *Cancel* to discard the changes.

NOTE: Depending on the type of thermal management unit, included components, and control settings of your system, all of the options listed may not be available on your Vertiv™ Liebert® iCOM™ display.

User Temperature Setpoint Options

BMS Backup Temp Setpoint

Selects a temperature setpoint that activates in the event of a BMS time out. The BMS timer must be configured for this setpoint to activate. See [Setting BMS Backup Setpoints](#) on page 75

Temperature Control Sensor

Selects sensor that controls cooling. Values are:

- Remote Sensor: Temperature control is based on the temperature reading(s) from wired remote sensor(s). See [Wired Remote Sensors](#) on page 112.
- Return Sensor: Temperature control is based on maintaining the temperature of the air returning to the cooling unit.

Temperature Setpoint Act

Read-only display of adjusted temperature setpoint when one of the following is active:

- Temperature compensation
- BMS backup temperature setpoint
- Customer input setpoint (remote alarm device)

Temperature Setpoint

Temperature that the unit maintains via cooling/reheat.

2.2 Viewing Unit Alarms

The ALARMS panel lists active alarm and warning events. **Table 21** on the facing page describes the type and state of the alarm shown by indicator dots.

Table 2.1 Alarm Status/Type Indicators

Indicator	Description
Yellow dot	Warning event.
Red dot	Alarm event.
Circle	Event condition has cleared, but still must be acknowledged. See Acknowledging Alarms on the next page .

2.2.1 To View Alarms

1. Touch , then  > *Alarms*. The ALARMS panel opens.
2. Touch an alarm to display the ALARM DETAILS panel.

Alarm Fields

Alarm

Name of the event.

Date

Date event was logged.

Time

Time event was logged

Alarm Detail Fields

Alarm

Name of the event.

Alarm Type

Number representing the event type.

- 1: Warning
- 2: Alarm

Date/Time

Date and time the event was logged.

Duration

Time elapsed since event was logged.

Threshold

Sensor reading at which an event is triggered.

Unit

Cooling unit to which the alarm applies.

Value

The current value to which the threshold is compared.

2.2.2 Silencing an Audible Alarm

Touch the screen to silence an audible alarm. If the alarm is non-latching, the alarm silences when the condition clears.

NOTE: The audible alarm must be enabled in display options to sound. See [Enabling the Audible Alarm Notification](#) on page 59 .

2.2.3 Acknowledging Alarms

Depending on the notification settings, alarms and warnings must be acknowledged or reset. An event is active as long as it is unacknowledged, with the exception of the network failure events described in [Table 2.2](#) on the facing page . Once acknowledged, an event remains active until the situation that triggered the event is resolved, see [Table 2.1](#) on the previous page , for event status indicators. When an event is acknowledged and cleared, it is removed from the Alarms panel and the LED stops flashing red.

NOTE: Acknowledging alarm events does not clear them. To clear an issue, it must be corrected, reset automatically by the controller or reset manually.

To Acknowledge Alarms

1. On the ALARMS panel, touch *Acknowledge All*.

A check mark overlays the status indicator of the active alarms and warnings, and these automatically clear when the condition is no longer present.

- If a critical event must be manually reset, the acknowledged items are listed with a Reset All button on the ALARMS panel.

2. Touch *Reset All* to manually reset the condition.

Table 2.2 Events That Clear without Acknowledgment

Network Failure	Description
UNIT XX DISCONNECTED	The Vertiv™ Liebert® iCOM™ I/O board assigned as U2U address number XX (two up to 32) has lost communication with the group. Make sure all units are powered on at the disconnect. Check cable connections and network settings where applicable.
NO CONNECTION W/UNIT 1	The Liebert® iCOM™ I/O board assigned as U2U address number 1 has lost communication with the group. Make sure all units are power on at the disconnect. Check cable connections and network settings where applicable.
BMS DISCONNECT	The BMS/BAS has not completed a handshake within the time defined by the BMS/BAS. Verify monitoring connections and communication to the BMS/BAS panel.
UNIT CODE MISSING	The factory unit code must be confirmed, saved and executed.
UNIT CODE MISMATCH	The factory unit code must be confirmed, saved and executed.

2.3 Viewing the Event Log

The event log is a list by date/time of the last 400 events generated by Vertiv™ Liebert® iCOM™ for the thermal management unit.

- On the User menu, touch *Event Log*.

The EVENT LOG for the cooling unit opens. **Table 2.3** below describes the color-coded status for each event.



NOTE: Depending on the type of thermal management unit, included components, and control settings of your system, all of the options listed may not be available on your Liebert® iCOM™ display.

Table 2.3 Event Status and Type Indicators

Indicator	Description
Green dot	Message.
Yellow dot	Unacknowledged warning event. See Acknowledging Alarms on the previous page .
Red dot	Unacknowledged alarm event. See Acknowledging Alarms on the previous page .
White dot with check mark overlay	Acknowledged event, the cause still exists.
White circle	Acknowledged event, the cause is cleared.

2.4 Viewing Sensor Data

The Sensor Data panel lists the standard and optional sensors monitored by Liebert® iCOM™ and the current reading of each sensor.



- Touch , then  > *Sensor Data*. The SENSOR DATA panel opens.

A secondary panel displays the DAILY SENSOR READING SUMMARY, which shows temperature, humidity and dew point readings for the cooling unit.

NOTE: Depending on the type of thermal management unit, included components, and control settings of your system, all of the options listed may not be available on your Liebert® iCOM™ display.

2.5 Managing Run Hours for a Component

You can view the run hours for components on a cooling unit, set the total run time limit, and reset total run hours to zero.

1. Touch , then  > *Total Run Hours*.
The RUN HOURS panel opens and the current hours for each component are listed in the Total Run Hours column.
To reset the total run hours to zero, see [Setting Run Hours to Zero](#) below .
2. Use the slider to set the total run time limit for each component, then touch *Save*.
The limits are set.

NOTE: Depending on the type of thermal management unit, included components, and control settings of your system, all of the options listed may not be available on your Liebert® iCOM™ display.

2.5.1 Setting Run Hours to Zero

1. On the RUN HOURS panel, touch to check each box in the *Total Run Hours* column next to the component(s) to reset. The Set to Zero button becomes available.
2. Touch *Set to Zero*. The total run hours for selected component(s) is set to zero.

2.6 Viewing Teamwork, Standby, and Cascade Status

In the main User panel, the Teamwork Mode icon indicates the mode selected, **Figure 2.1** below .

2.6.1 To View Teamwork Details

Touch the Teamwork mode icon.

The teamwork dialog opens displaying the teamwork mode, number of units in standby, and number of operating units.

NOTE: You must be logged in with the Service PIN to edit teamwork mode. See [Powering On the Vertiv™ Liebert® iCOM™ and Logging In/Unlocking Controls](#) on page 6 .

Figure 2.1 Teamwork Icons

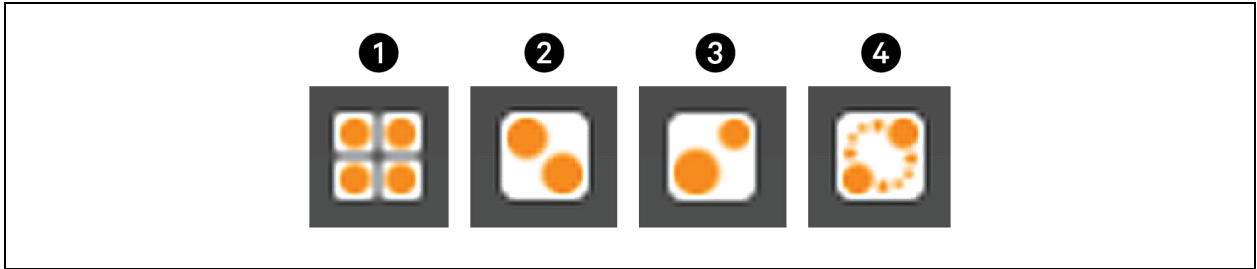

Item	Description
1	No teamwork.
2	Mode 1: Parallel teamwork
3	Mode 2: Independent teamwork
4	Mode 3 - Optimized aisle teamwork NOTE: Not applicable to Vertiv™ Liebert® Mini-Mate units.

This page intentionally left blank

3 Service Operation

3.1 Editing Setpoints for the Cooling Unit

Setpoints are the means by which cooling unit operation is controlled.

NOTE: Depending on the type of thermal management unit, included components, and control settings of your system, all of the options listed may not be available on your Vertiv™ Liebert® iCOM™ display.

3.1.1 Setpoints Options

Fan Control

See [Configuring Fan Setpoints](#) on page 36 .

High/Low Limit Control

See [Configuring High and Low Limit Setpoints](#) on page 31 .

Humidity Control

See [Configuring Humidity Setpoints](#) on page 32 .



Temperature Control

See [Configuring Temperature Setpoints](#) below .

Temperature Compensation

See [Setting Temperature Compensation](#) on page 30 .

3.1.2 Configuring Temperature Setpoints

1. Touch  , then  > *Setpoints* > *Temperature Control*.
The TEMPERATURE CONTROL secondary panel opens.
2. Refer to [Temperature Control Options](#) on the next page , [Temperature Control—Temperature Setpoints and Cooling Operation](#) on page 26 and [Compressor Control by Cooling Requirement](#) on page 28 to adjust the setpoint options, then touch *Save*.
The setpoint is updated.

NOTE: Proportional band setting is dependent on the heat load and the components specific to your cooling unit. Additional tuning may be required after start up when using PI temperature control. See [Considerations When Using PI Temperature Control](#) on page 28 .

NOTE: Depending on the type of thermal management unit, included components, and control settings of your system, all of the options listed may not be available on your Liebert® iCOM™ display.

Temperature Control Options

AutoSet Enabled

When enabled, the proportional band for temperature and humidity and both integration time factors are set automatically based on the type of cooling unit (single compressor, dual compressor or chilled water).

NOTE: General settings cannot be adjusted or changed when AutoSet is enabled. If you make a change when AutoSet is enabled, the parameter defaults back to its original setting.

BMS Backup Temp Setpoint

Temperature that the cooling unit maintains during BMS backup operation.

Dehumidification Reheat Proportional Band

Sets reheat operation independently from the Temperature Proportional band. Adjusts the activation point of dehumidification components based on deviation of the selected Dehumidification Reheat Temp Control sensor and the Dehumidification Reheat setpoint by placing half of the selected value on each side of the setpoint. A smaller number causes faster reaction to temperature changes.

Dehumidification Reheat Setpoint

Temperature that the unit maintains via dehumidification reheat.

Dehumidification Reheat Temp Control Sensor

Selects the sensor that controls dehumidification reheat. Values are:

- REM: Temperature control is based on the temperature reading(s) from wired remote/rack sensor(s). See [Wired Remote Sensors](#) on page 112 .
- RET: Temperature control is based on maintaining the temperature of the room air.

Heater Deadband

Widens the setpoint to prevent small temperature changes from cycling re-heat components.

Temperature Control Sensor

Selects sensor that controls cooling. Values are:

- Remote Sensor: Temperature control is based on the temperature reading(s) from wired remote/rack sensor(s). See [Wired Remote Sensors](#) on page 112 .
- Return Sensor: Temperature control is based on maintaining the temperature of the room air.

Temperature Control Type

Control when staging cooling and heating operations. Valid values are:

- Proportional: Percent of cooling/heating determined by the difference between the air temperature sensor reading and the temperature setpoint.
- PI: Percent of cooling/heating calculated using the temperature proportional band and temperature integration time settings. See [Considerations When Using PI Temperature Control](#) on page 28 .
- Adaptive PID: Auto-tuning PID control loop, can be set for Cooling. Only available on Vertiv™ Liebert® CW (chilled water) systems.
- Intelligent: Percent of cooling/heating determined by programmed logic that simulates manual human control.

Temperature Deadband

Widens the setpoint to prevent small temperature changes from cycling compressors and valves maximizing component life. When temperature is within the deadband, no change of the control output (heating/cooling) occurs.

Temperature Integration Time

Adjusts amount of cooling/heating based on the length of time the temperature has deviated from the setpoint. The time selected is the amount of time it will take cooling capacity to reach 100%. For example, if three minutes is selected, cooling capacity will increase to 100% in three minutes.

NOTE: Three to five minutes of integration time is adequate for most applications. See [Considerations When Using PI Temperature Control](#) on page 28 .

NOTE: Only used when Temperature Control Type is PI.

Temperature Proportional Band

Adjusts the activation point of cooling/heating components based on deviation from setpoint by placing half of the selected value on each side of the temperature-control setpoint. A smaller number causes faster reaction to temperature changes.

NOTE: Setting this too low causes short cycling of compressors.

Temperature Setpoint

Temperature that the unit maintains via cooling/reheat.

Temperature Setpoint Act

Read-only display of adjusted temperature setpoint when one of the following is active:

- Temperature compensation
- BMS backup temperature setpoint

3.1.3 Temperature Control—Temperature Setpoints and Cooling Operation

Temperature control refers to the cooling unit’s response to programmed setpoints and sensed room/load conditions. Temperature control is closely tied to the primary cooling source. Liebert Thermal management units employ several types of primary cooling sources.

Compressor Operation

Vertiv™ Liebert® iCOM™ controls the cooling units based on a calculated need for cooling (and heating, if included on your system). The requirement is expressed as a percentage (%) and is calculated using the selected temperature control type.

Temperature Proportional Band

Use the proportional and deadband parameters to control how your cooling unit(s) respond based on the calculated need for cooling (or heating). **Figure 3.1** below, illustrates temperature control using:

- 70° setpoint
- 10° proportional band
- No deadband

The proportional band is divided evenly on each side of the setpoint.

- 0% cooling capacity is required at 70°.
- As the air temperature increases, cooling also increases along the proportional band.
- If the air temperature reaches 75°, the system operates at 80% cooling capacity.
- If air temperature rises to the end of the proportional band or further, the system operates at 100% capacity to bring the temperature down to the setpoint.
- If your unit includes reheat, the heating capacity operates in the same way as the air temperature falls below the setpoint. See [Reheat Control](#) on page 47.

Figure 3.1 Temperature Control without a Deadband

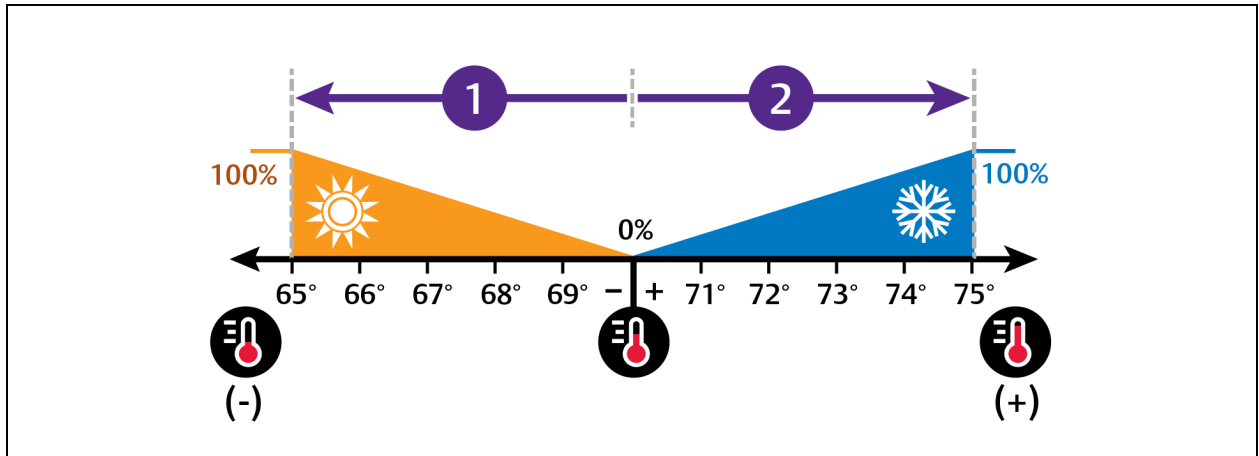

No.	Description
1	½ of proportional band.
2	½ of proportional band.

Temperature Deadband

A deadband widens the setpoint to prevent small temperature changes from activating compressors and valves and cause excessive component cycling. **Figure 3.2** below, illustrates temperature control using:

- 70° setpoint
- 10° proportional band
- 2° deadband

Like the proportional band, the deadband is also divided evenly on each side of the setpoint.

- 0% cooling capacity is required from 69° to 71°.
- At 71°, the system operates according to the temperature proportional band.

Figure 3.2 Temperature Control with a Deadband

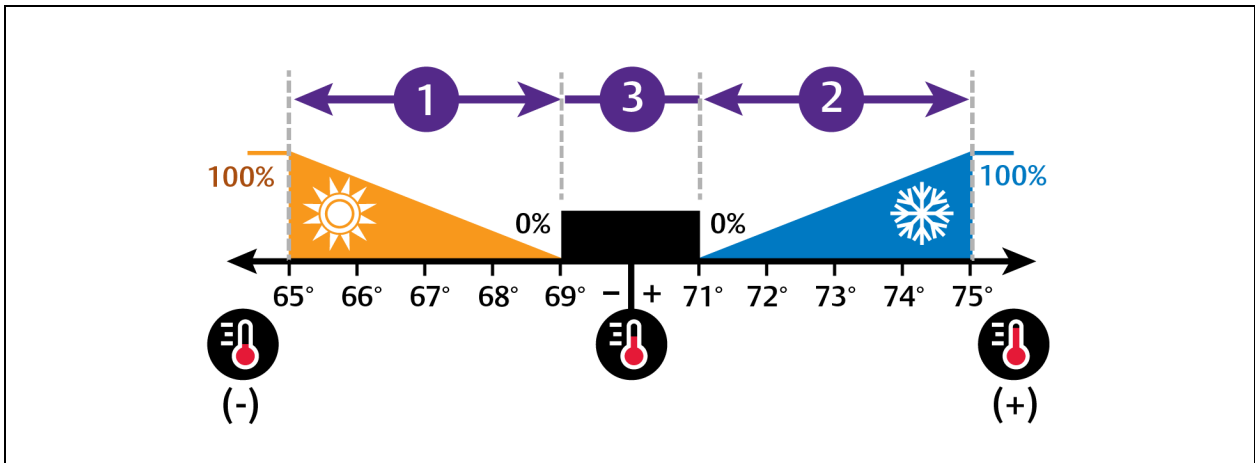

No.	Description
1	½ of proportional band.
2	½ of proportional band.
3	Deadband.

Considerations When Using PI Temperature Control

Several factors, such as room heat load, external heat gains, and component specific performance can affect the PI control loop. Adjusting the temperature proportional band and integration time can improve cooling unit performance and avoid problems detailed in **Table 3.1** below .

Table 3.1 PI Temperature Control Troubleshooting

Problem	Solution
Cooling is slow to activate	Decrease the proportional band slightly and monitor operation. Repeat until cooling reaction time is acceptable.
Compressor short cycle alarm	Increase the proportional band slightly by increasing the integration time between three and five minutes, and monitor compressor run time. Set the temperature deadband to 2. Run time must be more than three minutes to prevent a short cycle of the compressor.
Excessive valve oscillation or hunting	Increase the proportional band and/or increase integration time.

3.1.4 Compressor Control by Cooling Requirement

Compressor control is directly linked to temperature control in that the cooling requirement determined by the temperature proportional band determines compressor operation. Depending on the type of cooling unit, the number and type of compressors varies. The following describes compressor operation along the proportional band for the varying compressor options.

Digital Scroll Compressors

Digital scroll compressors use time loaded/un-loaded to modulate cooling capacity between 40% and 100% to control cooling more precisely than non-digital compressors. Capacity modulation is achieved by opening and closing a digital solenoid valve in 15 second intervals while the compressor runs continuously when the cooling requirement is 40% to 100%.

- When the valve is opened and energized, the compressor is unloaded and capacity is 0% because the scroll plates are separated so that there is no refrigerant flowing through the compressor.
- When the valve is closed (de-energized), the compressor is loaded and capacity is 100%.
- Capacity is determined by the amount of time that the valve is closed in the 15 second interval. **Figure 3.3** on the facing page illustrates solenoid valve operation when cooling requirement is 66%.
 - The valve is closed for 10 seconds (100% cooling).
 - Then open for 5 seconds (0% cooling).
 - This results in 66% cooling. Essentially, the compressor is partially loaded.

Figure 3.3 Digital Scroll Compressor Operation to Provide 66% Cooling Capacity

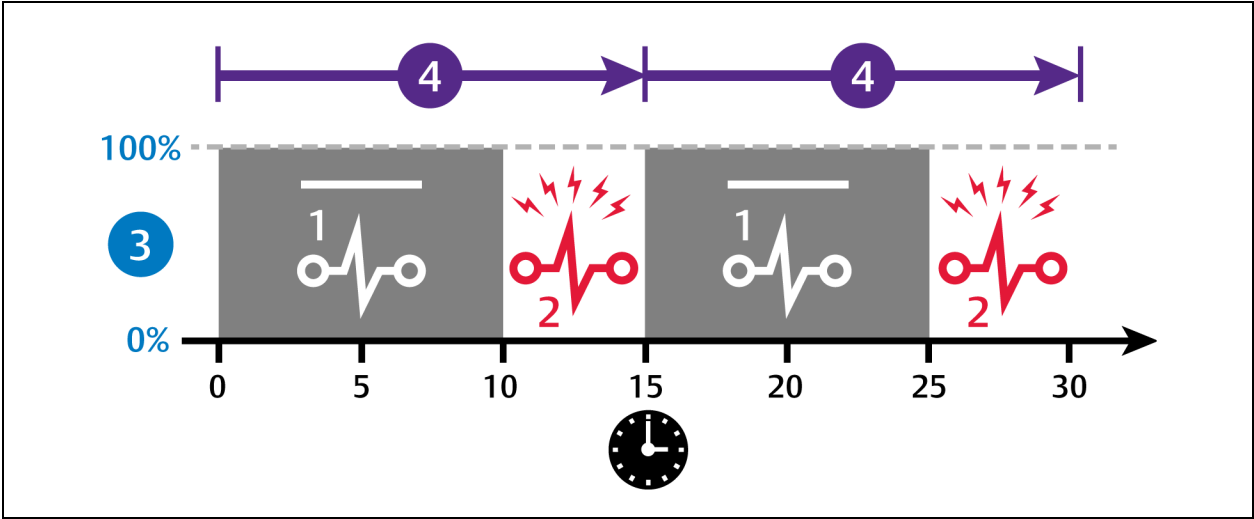

No.	Description
1	Solenoid de-energized.
2	Solenoid energized.
3	Percent loaded.
4	15 second capacity modulation cycle.

One Digital Scroll Compressor

In a single digital scroll system:

- The compressor starts when the cooling demand is at least 25% (calculated from temperature proportional band) and operates at 50% capacity (valve open 7.5 sec/closed 7.5 sec) for an initial period set in Winter Start Delay, see [Setting Low Pressure Time Delay](#) on page 45 , after which it operates per cooling demand.
- As cooling demand increases, the length of time the valve is closed increases/capacity increases.
- At 100% cooling requirement, the valve remains closed for the entire 15-second interval and the compressor is operating loaded at 100% capacity.
- The compressor stops when cooling demand decreases to 10%.

Figure 3.4 on the next page illustrates digital scroll compressor operation with the following setpoint parameters:

- 70° setpoint
- 8° proportional band
- 2° deadband

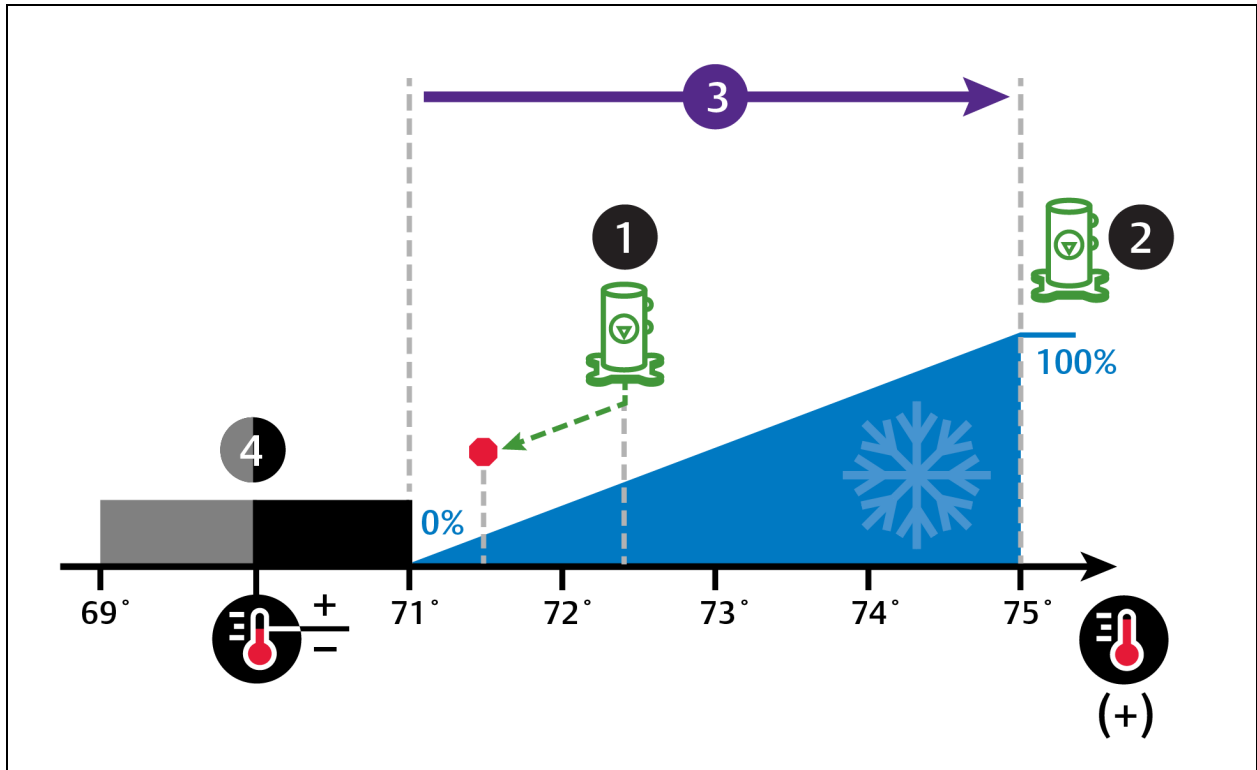

Figure 3.4 Compressor Control—Single Digital Scroll Compressor



No.	Description
1	Digital scroll begins operation.
2	Digital scroll operation at 100%
3	½ of proportional band.
4	Deadband

3.1.5 Setting Temperature Compensation

Temperature compensation provides protection from changes that affect capacity and heat load by monitoring temperature conditions and fan speed settings, then automatically adjusting the temperature setpoint. Changes that may cause temperature compensation are floor tile removal in non-cold aisle areas, unit failure in a neighboring zone, or unexpected heat load fluctuations at rack equipment.

1. Touch , then  > *Setpoints* > *Temperature Compensation*. The TEMPERATURE COMPENSATION secondary panel opens.

2. Select the Compensation Type, then touch *Save*. The setpoint is updated.
 - Return temperature compensation cannot be used when both fan and cooling control is set to Return.

NOTE: When temperature compensation is enabled and active, the Temperature Setpoint Act field on the Temperature Control setpoints panel displays the adjusted setpoint value.

NOTE: Depending on the type of thermal management unit, included components, and control settings of your system, all of the options listed may not be available on your Vertiv™ Liebert® iCOM™ display.

Temperature Compensation options

Compensation Type

Selects the compensation routine.



- No: Temperature compensation routine disabled.
- Return: Increases the temperature setpoint when the return air temperature is too cold.

3.1.6 Configuring High and Low Limit Setpoints

Setting the dehumidification low limits avoids over cooling a room during dehumidification. When a low limit is reached, the cooling source used for dehumidification is disabled. Dehumidification resumes when air temperature rises above the low limit reset value.

NOTE: Dehumidification lock out can occur with improper low limit settings. To avoid lock out, increase heat load for efficient operation, decrease low limit settings slightly, and where applicable, decrease the reheat proportional band to allow reheat sooner.

To Set High and Low Limits

1. Touch  , then  > *Setpoints* > *High/Low Limit Control*. The HIGH/LOW LIMIT CONTROL secondary panel opens.
2. Adjust the setpoint options, then touch *Save*. The setpoint is updated.
 - Touch *Cancel* to discard the changes.

NOTE: Depending on the type of thermal management unit, included components, and control settings of your system, all of the options listed may not be available on your Liebert® iCOM™ display.

High and Low Limit Control Options

Dehum Low Limit X

Temperature at which dehumidification is interrupted, where X is limit 1 or 2.

Dehumidification Low Limit Sensor

Selects the sensor that is used for the low limit determination.

Dehumidification Low Limit Setpoint

Temperature below which dehumidification is disabled.



High Return Limit

Enables/disables use of additional fan speed based on return air temperature.

Return Limit P-Band

Calculates fan speed based on proportional deviation from the return air temperature.

3.1.7 Configuring Humidity Setpoints

1. Touch , then  > *Setpoints* > *Humidity Control*. The HUMIDITY CONTROL secondary panel opens.
2. Refer to [Humidity Control Options](#) below and [Humidity Control](#) on the facing page to adjust the setpoint options, then touch *Save*. The setpoint is updated.
 - Touch *Cancel* to discard the changes.

NOTE: Depending on the type of thermal management unit, included components, and control settings of your system, all of the options listed may not be available on your Vertiv™ Liebert® iCOM™ display.

Humidity Control Options**Control Dew Point**

Dew point setpoint.

Dew Point Deadband

Widens the setpoint to prevent small changes from cycling compressors and valves maximizing component life. When temperature is within the deadband, no change of the control output (humidification) occurs.

Dew Point P-Band

Adjusts the activation point of humidifier/dehumidification components based on deviation from setpoint by placing half of the selected value on each side of the dew point setpoint. A smaller number causes faster reaction to humidity changes.

Dew Point Setpoint

Humidity level (based on actual return air temperature and humidity) by adding moisture to or removing moisture from the air.

Humidity Control Sensor

Selects sensor used when calculating relative humidity.

NOTE:**Humidity Control Type**

Controls humidification/dehumidification operation. Valid values:

- Proportional: percent of humidification/dehumidification determined by the difference between the humidity sensor reading and the humidity setpoint.
- Dew Point: percent of humidification/dehumidification determined using the measured return temperature and humidity to calculate the dew point and comparing it to the setpoints.

NOTE: When dew point is selected, the humidity setpoint and proportional band units are degrees dew point.

- Relative: Percent of humidification/dehumidification determined using the measured humidity content of the air to calculate the percent relative humidity (RH) and comparing it to the setpoints.

NOTE: Relative humidity control can cause unnecessary humidification/dehumidification from over cooling based on a higher than normal RH reading that causes extended dehumidification. This in turn causes a low RH reading that activates the humidifier.

- Compensated: Percent of humidification/dehumidification determined using the measured humidity content of the air and automatically adjusting the humidity setpoint.

NOTE: Compensated humidity control prevents unnecessary humidification/dehumidification noted with relative humidity control.

- Predictive: Percent of humidification/dehumidification determined using the measured humidity content of the air and automatically adjusting the humidity sensor reading.

Humidity Deadband

Widens the setpoint to prevent small changes in humidity from cycling components and also maximizes component life. When humidity is within the deadband, no humidification/dehumidification occurs.

Humidity Integration Time

Adjusts unit capacity based on the length of time the humidity has deviated from the setpoint. Works in conjunction with the proportional band to maintain tight setpoint control.

Humidity Proportional Band

Adjusts the activation point of humidifier/dehumidification components based on deviation from setpoint by placing half of the selected value on each side of the humidity control setpoint. A smaller number causes faster reaction to humidity changes.

Humidity Setpoint

Humidity level by adding moisture to or removing moisture from the air.

3.1.8 Humidity Control

Humidity control refers to the cooling unit's response to programmed setpoints and sensed humidity conditions.

Vertiv™ Liebert® iCOM™ controls humidity based on temperature and humidity sensor readings. The requirement is expressed as a percentage (%) and is calculated using the selected humidity control type.

Humidity Proportional Band

Use the proportional and deadband parameters to control how your cooling unit(s) respond based on the calculated need for humidification/dehumidification. As the return air humidity deviates from the humidity setpoint, Vertiv™ Liebert® iCOM™ responds with a humidification or dehumidification capacity of 0% to 100% in 1% increments.

Figure 3.5 below, illustrates humidity control using:

- 50% setpoint
- 8% proportional band
- No deadband

The proportional band is divided evenly on each side of the setpoint.

- 0% humidifying capacity is required at the humidity setpoint.
- The humidifier starts operating when the humidification requirement reaches 100% and continues to operate until the humidification requirement drops to 0%. During this period, the display shows 100% humidification
- The dehumidifying capacity responds in the same way as the return air humidity rises above the setpoint. Dehumidification is accomplished by a request for cooling that activates as soon as the required dehumidifying capacity reaches 100% and continues operating until the required dehumidifying capacity drops to 0%. During this period, the digital compressor loading scales between a minimum percentage (advanced setting: A557) and 100% depending upon required dehumidifying capacity. The display always shows 100% dehumidification.

Figure 3.5 Humidity Control Without a Deadband

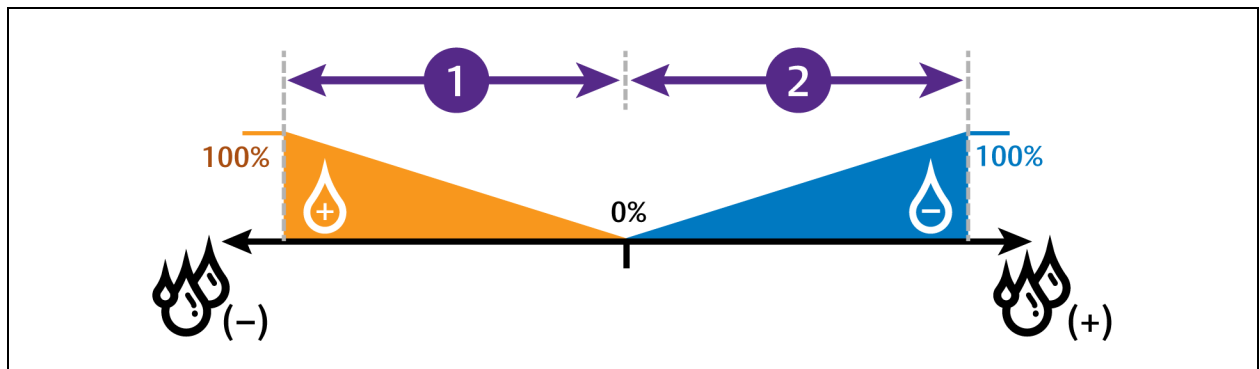

No.	Description
1	½ of proportional band.
2	½ of proportional band.

Humidity Deadband

A deadband widens the setpoint to prevent small changes in humidity from activating humidifiers, compressors and valves and cause excessive component cycling.

Figure 3.6 below, illustrates humidity control using:

- 50% setpoint
- 8% proportional band
- 2% deadband

Like the proportional band, the deadband is also divided evenly on each side of the setpoint.

- 0% cooling capacity is required from 49% to 51%.
- Below 49%, humidification operates according to the humidity proportional band.
- Above 51%, dehumidification operates according to the humidity proportional band.

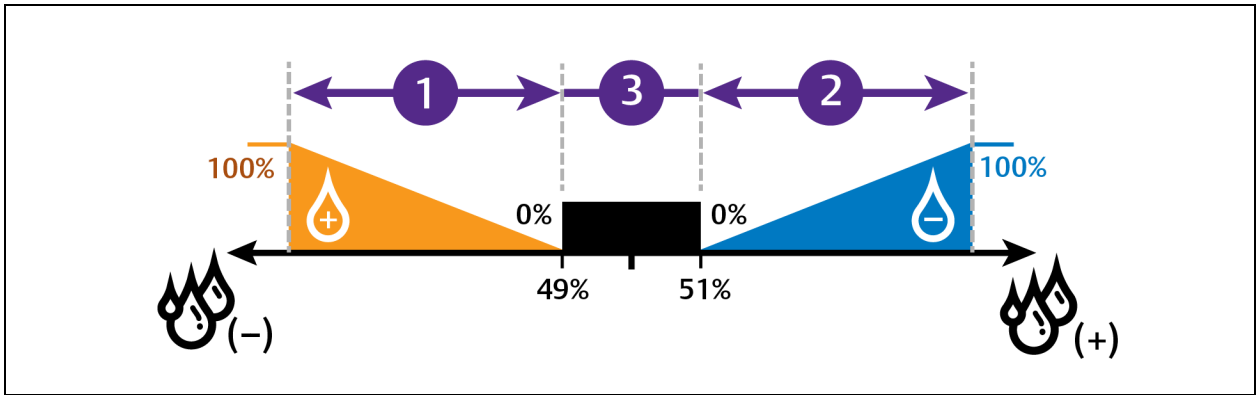

Figure 3.6 Humidity Control with a Deadband



No.	Description
1	½ of proportional band.
2	½ of proportional band.
3	Deadband.

3.1.9 Configuring Fan Setpoints

Configures fan speed control to operate independent of compressor loading (decoupled mode).

1. Touch , then  > *Setpoints* > *Fan Control*. The FAN CONTROL secondary panel opens.
2. Adjust the setpoint options, then touch *Save*. The setpoint is updated.
 - Touch *Cancel* to discard the changes.

NOTE: Depending on the type of thermal management unit, included components, and control settings of your system, all of the options listed may not be available on your Vertiv™ Liebert® iCOM™ display.

Fan Control Options

Airflow Calibration

Maximum allowed fan output voltage.

Fan Control Sensor

Selects the sensor that controls automatic fan speed, see [Automatic Fan Speed Control](#) on page 38 ,

– or –

Selects manual control, see [Manual Fan Speed Control](#) on the facing page .

Options are:

- Remote : Air flow/fan speed is adjusted based on reading from a wired, remote temperature sensor. If Remote is selected for the Temperature Control Sensor, then this fan control option defaults to Remote. See [Configuring Temperature Setpoints](#) on page 23 .
- Return: Air flow/fan speed is adjusted based on reading from the wired, return air temperature sensor. If Return is selected for the Temperature Control Sensor, then this fan control option defaults to Return, see [Configuring Temperature Setpoints](#) on page 23 .
- Manual: Air flow/fan speed is adjusted using a building management system.
- PI: Regulation is based on proportional and integral terms. Provides best temperature control and helps avoid fan speed oscillation.
- Adaptive PID: Auto-tuning PID control loop, can be set for cooling or fan speed.

Fan Delta

Fan temperature setpoint, it is the temperature difference compared to the cooling setpoint.

Fan Speed Proportional Band

Adjusts the fan speed based on the deviation from the setpoint. A smaller number causes faster reaction to temperature changes.

Fan Speed Integration

Adjusts fan speed based on time away from the setpoint to maintain accurate temperature control.

Maximum Fan Speed

Maximum percentage at which the fans will operate.

Minimum Fan Speed





Minimum percentage at which the fans will operate.

3.1.10 Manual Fan Speed Control





In Manual fan control mode, the speed of the motor can be set in one of the following ways:

- The manual (fixed) fan speed may be set via iCOM.
- Hard wired analog input (input signal types including 4 to 20 mA, 0 to 10 VDC, and 0 to 5 VDC) and a factory supplied isolator to ensure reliable communication.
- Remotely using Liebert® Embedded Unity.

Setting Manual Fan Speed Control via Analog Input

1. Touch , then  > *Setpoints* > *Fan Control*, set *Fan Control Sensor* to *Manual*, then touch *Save*.
2. Touch , then  > *Auxiliary Device Setup* > *Analog Input*.
3. On ANALOG INPUTS, touch *Customer Analog Inputs* to expand it, then touch the analog input device corresponding to fan speed control.
4. On the ANALOG INPUT PROPERTIES panel, adjust the properties, then touch *Save*.
 - Touch *Cancel* to discard the changes without saving.

Setting Manual Fan Speed Control via BMS

1. Touch , then  > *Setpoints > Fan Control*, set *Fan Control Type* to *Manual*, then touch *Save*.
2. Touch , then  > *BMS & Teamwork Setup > BMS Setup*.
3. On BMS SETUP, touch *Control Settings*. The CONTROL SETTINGS secondary panel displays:
 - In *Fan Control Sensor*, select *Manual*.
 - In *BMS Fan Speed Local Override*, select *No*.
 - Touch *Save*. BMS control of fan speed is set, and the BMS set fan speed is displayed on the Fan Speed slider.

NOTE: Set the fan speed via BMS by writing to the Fan Speed Maximum Set Point monitoring point. For details, see SL-28170 IntelliSlot Reference Guide found at <https://www.vertiv.com/en-us/support/>.

NOTE: Local adjustments to fan speed are overridden when remote/BMS fan speed control is set.

3.1.11 Automatic Fan Speed Control



Temperature sensors can control fan speed using one of two modes based on the type of sensor selected as the fan-control sensor: return, or remote, see **Table 3.2** below . Control is based on the selected sensor for both fan control and temperature control and their setpoints as follows:

- Coupled: The fan control and temperature control sensor selection is the same. When coupled, fan speed is determined by the temperature setpoints.

Table 3.2 Fan Speed Controlling Sensor Options

		Temperature Control Sensor Selected	
		Remote Sensor	Return Sensor
Fan Control Sensor Selected	Remote Sensor	Coupled	N/A
	Return Sensor	N/A	Coupled

To Set Parameters for Automatic Fan Speed Control



1. Touch , then  > *Setpoints > Fan Control*,
 - Set *Fan Control Type* to **Manual**
 - Select a *Fan Control Sensor*.
 - Adjust the setpoint options, then touch *Save*.

Sensor-based fan speed control is set.

2. Touch *Temperature Control*.
3. On the TEMPERATURE CONTROL secondary panel:
 - Select a *Temperature Control Sensor*.
 - Adjust the setpoint options, then touch *Save*.

3.1.12 Scheduling Sleep Times for Thermal Management Units

Unit sleep schedules turn off units during low demand as long as return temperature remains below the alarm threshold.

1. Touch , then  > *Scheduler > Unit Sleep Schedule*. The TASK PROPERTIES panel opens.
2. Adjust the schedule settings, and touch *Save*. The schedule is set up.
 - Touch *Cancel* to discard the changes.

Unit Sleep Schedule Task Properties Options

Interval 1/2

Start and finish time of day that sleep mode operates.

Interval Day

Selects days on which sleep mode operates for the intervals specified in Interval 1 and Interval 2.

Sleep Mode

Enable/disable sleep schedule. When checked, the schedule is run. When not checked, the scheduling parameters are ignored.

Timer Mode Type

Selects unit operation when in sleep mode. Values are:

- Unit Off: The unit stops (fans are off).
- Deadband: The unit operates in a limited capacity (fans are on) based on an additional deadband added to the temperature deadband.

Timer Reset

Selects whether or not the sleep-mode timer resets.



Whole Day

Selects specific days on which sleep mode is active for the entire day when the schedule is enabled.

3.2 Setting General Thermal Management Unit Options

NOTE: Depending on the type of thermal management unit, included components, and control settings of your system, all of the options listed may not be available on your Vertiv™ Liebert® iCOM™ display.

3.2.1 Setting Miscellaneous Options

1. Touch , then  > *Options Setup* > *Misc Settings*. The MISC SETTINGS panel displays.
2. Make adjustments as needed and click *Save*. The option settings are updated.
 - Touch *Cancel* to discard the changes without saving.

NOTE: Depending on the type of thermal management unit, included components, and control settings of your system, all of the options listed may not be available on your Vertiv™ Liebert® iCOM™ display.

Miscellaneous Cooling Unit Settings Options**Auto Restart Enable**

When enabled, the cooling unit returns to the status at which it was operating when input power returns after a power failure. (ON if it was powered on and OFF if it was powered off before the failure.) See [Automatic Restart after Power Failure](#) on page 43.

Cascade after Remote On

Upon a remote request for all units to start, selects whether or not the units start one after another by the Cascade Units Delay set in [Teamwork Modes](#) on page 67, see the [Teamwork Control Options](#) on page 68.

Display Off Enabled

On this cooling unit, sets whether or not the unit powers on/off when the on/off button on the Vertiv™ Liebert® iCOM™ display is used.

- No: On and off requests via the display are ignored.
- Yes: Unit powers on/off when requested via the display.

Free Cool Capacity Transition Filter

Selects how quickly capacity changes between modes of operation to avoid overshooting during the transition.

- Only a factory trained service technician should adjust this setting.

K11 Active On

Selects the action of the activated K11 (warning) relay. Options are:

- Dehum: Dehumidification is on.
- Warning: A warning is active.
- Emergency Pwr: Emergency power is on.
- Freecooling: Free cooling is on.
- FC Start: Free cooling is in the start phase or is on.

K11 (WA Relay) and AL Relay

Sets action of the alarm and warning relays.

- Direct: Open when power is applied to the control.
- Reverse: Closed when power is applied to the control.

Loss of Power Auto Reset Delay

Selects the length of time that a Loss of Power event (that triggers after a power cycle that occurs when the cooling unit is operating) is active when power is restored. When the delay time elapses, the event resets and is cleared automatically.

Operation at Temp Control Sensor Failure

Selects cooling unit operation in the event that the control temperature sensor fails.

- Shut down: The unit shuts down on sensor failure.
- Cooling: The unit continues operation based on the select Temp Control Sensor Failure Cooling Mode.

Restart at BMS Off and Disconnected

Selects the cooling unit's response/action when the BMS is disconnected.

- No: Unit remains in a monitoring off state.
- Yes: Unit may power on from a monitoring off state.

Single Unit Auto Restart

Selects time elapsed (in seconds) before unit restarts when Auto Restart Enable is enabled.

Temp Control Sensor Failure Cooling Mode

Unit operation when Cooling is selected at control temperature sensor failure.

- Hold: Holds the last call for cooling. That is, continue operating at same capacity.
- Full: Activates full cooling, 100% capacity.



Warning Activates Alarm Relay

When enabled, a warning event activates the common alarm relay.

3.2.2 Configuring Quick Start

In the event of a power interruption to the Vertiv™ Liebert® iCOM™ controller, the unit components and controls shut down. Normally, after power is restored, the iCOM controller must fully boot, and no cooling or air flow occurs until the controls have fully booted. Quick Start lets you determine the fan and cooling output that the unit will provide before the controller fully boots. When configured, the unit can provide airflow and cooling within 10 seconds after power is restored to the controller. Quick Start can be applied to fan, chilled water, DX, and pre-pump functions. Quick Start operates only during Liebert® iCOM™ application boot, then normal controller operation resumes.

To Configure Quick Start

1. Touch , then  > *Options Setup* > *Quick Start Settings*. The QUICK START SETTINGS panel displays.
2. Refer to [Quick Start Options](#) below, and select the configuration options for your system.

NOTE: Depending on the type of thermal management unit, included components, and control settings of your system, all of the options listed may not be available on your Vertiv™ Liebert® iCOM™ display.

Quick Start Options

CW Quick Start

Enables/disables chilled water quick start.

CW Quick Start Delay

Delay before chilled water function activates after power is restored (0 to 180 sec).

CW Valve 1 Analog Output

Position percentage open of chilled water valve 1 during quick start operation (0 – 100%).

Fan Quick Start

Enables/disables fan quick start.

Quick Start Delay

Delay before quick start activates after power is restored (0 to 180 sec).

Quick Start Fan Analog Output



Fan speed percentage during quick start operation.

Quick Start Overlap Time

Length of time quick start fan speed overlaps normal fan speeds settings. After fully booted, normal fan speed control resumes when this time expires.

3.2.3 Automatic Restart after Power Failure



Set the cooling unit to return to the status at which it was operating when input power returns after a power failure. (ON if it was powered on and OFF if it was powered off before the failure.)

1. Touch , then  > *Options Setup* > *Misc Settings*.
The MISC SETTINGS panel displays.
2. Set *Auto Restart Enable* to **Yes**, and use the slider to set the number of seconds to delay before restart, then touch *Save*.
Automatic restart is enabled.
 - Touch *Cancel* to discard the changes without saving.

3.2.4 Setting Fan Options

Air flow is adjustable via Vertiv™ Liebert® iCOM™ manually using a BMS or automatically using locally installed temperature sensors.

NOTE: Thermal management units ship with the factory setting Return Sensor for the temperature control sensor and the fan speed control sensor.

1. Touch , then  > *Options Setup* > *Fan Settings*. The FAN SETTINGS panel displays.
2. Make adjustments as needed and click *Save*.
The option settings are updated.
 - Touch *Cancel* to discard the changes without saving.

NOTE: Depending on the type of thermal management unit, included components, and control settings of your system, all of the options listed may not be available on your Vertiv™ Liebert® iCOM™ display.

Fan Settings Options

Airflow Calibration

Maximum allowed fan output voltage.

Allow Fan Modulation with Comp

Enables/disables fan modulation with compressor operation. Values are:

- No: Fan speed ramps to STD when a compressor starts operating.
- Yes: Fan speed modulates based on CFF while compressor operates.

Dehumidification Fan Speed

Maximum fan speed when dehumidification is in progress, assisting with the dehumidification process.

Fan Backdraft Mode

Enables/disables fan operation in back draft mode.

Fan Shutdown Delay Timer

Length of time that the fan continues to operate after the cooling unit is turned off via the display, local control or the BMS.

- The delay timer does not apply when the unit is turned off remotely.

Fan Speed at Unit Start

Speed at which the fans run on unit start up.

Fan Speed at Unit Start Timer

Length of time fans run at the speed selected in fan speed at unit start.

Fan Speed Filter at 0%

Decreases the rate at which the fan speed changes when close to or at the temperature setpoint to avoid undershooting the setpoint.

Fan Speed Filter at 100%

Increases the rate at which the fan speed changes for a quicker reaction of fan speed at high temperatures.

Fan Speed Reposition Delay

Length of time before fan speed can decrease, allowing temperature to stabilize before the change occurs.

Fan Speed Reposition Mode

Sets a one-time delay that allows the fan to maintain current speed when a call to increase or decrease is made to allow the temperature to stabilize.

Fan Speed Transition Filter

Sets how quickly the fan speed changes between operating modes. Prevents an instant reaction when fans turn on or off and prevents unstable operation.

Max Deceleration Rate

Selects the rate and which the fan speed changes during deceleration.

Maximum Fan Speed

Maximum speed at which the fan will operate.



Minimum Fan Speed

Minimum speed at which the fan will operate.

No Power Fan Speed

Speed at which the fans operate when using emergency power.

3.2.5 Setting Compressor Options

1. Touch , then  > *Options Setup* > *Compressor Settings*. The COMPRESSOR SETTINGS panel displays.
2. Make adjustments as needed and click *Save*. The option settings are updated.
 - Touch *Cancel* to discard the changes without saving.

NOTE: Depending on the type of thermal management unit, included components, and control settings of your system, all of the options listed may not be available on your Vertiv™ Liebert® iCOM™ display.

Compressor Settings Options

Compressor Capacity Filter at 0%

Decreases the rate at which cooling capacity changes when close to or at the temperature setpoint to avoid undershooting the setpoint.

Compressor Capacity Filter at 100%

Increases the rate at which the cooling capacity changes for a quicker reaction of cooling at high temperatures.



Winter Start Delay

Length of time, in minutes, that a low pressure condition is ignored during compressor start-up. See [Setting Low Pressure Time Delay](#) below .

Setting Low Pressure Time Delay



At compressor start up, a low pressure condition is ignored for a set period to avoid false trips due to bubbles in the refrigerant or another misreading of the low pressure device.

NOTE: The factory default setting is a four minute delay.

1. Touch , then  > *Options Setup* > *Compressor Settings*.
2. Use the *Winter Start Delay* slider to select the number of minutes for the delay, and touch *Save*.

3.2.6 Setting Reheat Options

If the room air temperature becomes too cold, heating is activated based on the temperature proportional band setting. Depending on the type of cooling unit, there are different types of reheat (configured at purchase and set at factory). There may also be one to three stages of reheat, which are also factory set. The only service operation available is setting the number of heat stages.

1. Touch , then  > *Options Setup* > *Reheat Settings*. The REHEAT SETTINGS panel displays.
2. Refer to [Reheat Settings Options](#) below, and [Reheat Control](#) on the facing page to adjust the setpoint options, then touch *Save*.
The option settings are updated.
 - Touch *Cancel* to discard the changes without saving.

NOTE: Depending on the type of thermal management unit, included components, and control settings of your system, all of the options listed may not be available on your Vertiv™ Liebert® iCOM™ display.

Reheat Settings Options

Electric Heat Outputs

Shifts the output steps of the electric heaters.

Electric Heat Staging

Selects the electric heat staging option.

- No. Reheat is not available for Mini-Mate.

Enable Hot Gas Heat

Enables/disables hot gas reheat.

- No. Reheat is not available for Mini-Mate.

Reheat Operation

Selects when heating is allowed.

- Dehum: Heating only allowed during dehumidification.
- Normal: Heating allowed during all operating modes.

SCR Control Type

Enables/disables SCR reheat. (May not be included on your cooling unit.) See [Reheat Control](#) on the facing page. Values are:

- None: SCR reheat disabled.
- Tight: Use tight control reheat mode.
- Standard: Use standard reheat mode.

Electric Heat Stages

Number of electric stages that may be activated during reheat.

- Mini-Mate has single stage reheat.

3.2.7 Reheat Control

If your cooling units are equipped with a heating option, reheat control is directly linked to temperature control in that the heating requirement determined by the temperature proportional band determines reheat operation. See [Temperature Control—Temperature Setpoints and Cooling Operation](#) on page 26 .

Electric Reheat

Reheat is controlled by the heating half of the temperature proportional band (below the setpoint). **Figure 3.7** on the next page illustrates single stage electric reheat operation:

- 70° setpoint
- 8° proportional band
- 2° deadband

The proportional band is divided evenly on each side of the setpoint. The deadband is divided evenly on each side of the setpoint.

- From 70° to 69°, 0% heating is required.
- At 65° air temperature (heating demand 100%), electric reheat activates and continues operating until temperature reaches 69° (heating demand 0%).

Figure 3.7 Temperature Control for Reheat—Single Stage Electric Reheat

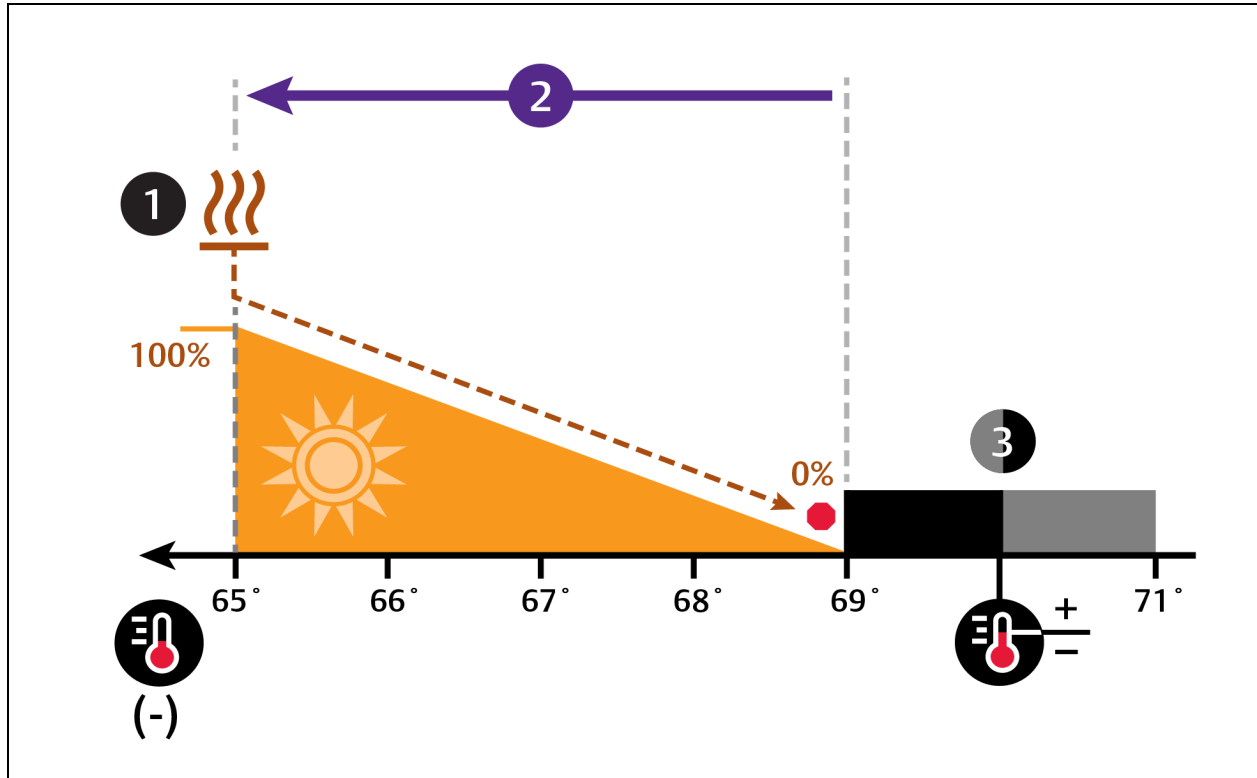

No.	Description
1	Reheat operation begins.
2	½ of proportional band.
3	Deadband.

SCR Reheat

SCR reheat uses pulsed on/off operation to modulate heating capacity to control temperature more precisely than staged, electric reheat. 100% heating capacity is constant operation of SCR reheat. As the temperature proportional band requires more heat, the SCR output adjusts proportionally.

SCR Reheat—Standard Mode

NOTE: Standard SCR Reheat when used in conjunction with variable cooling capacity (such as chilled water, variable-speed fans or digital scroll compressors) provides ultimate capacity control and energy efficiency gains.

In standard mode, SCR reheat responds to a 0% to 100% heating requirement based on the temperature proportional band.

Figure 3.8 below illustrates SCR reheat in standard mode as follows:

- 70° setpoint
- 8° proportional band
- No deadband

The proportional band is divided evenly on each side of the setpoint. The deadband is divided evenly on each side of the setpoint.

- At 70° air temperature (heating demand 0%), no heating occurs.
- When temperature decreases below the setpoint, SCR reheat activates, and increases output as the heating demand increases from 0% to 100%.
- As air temperature rises and heating demand decreases, the SCR reduces output and stops operating when 70° (0% heading demand) is reached.

Figure 3.8 Temperature Control for Reheat—SCR in Standard Mode

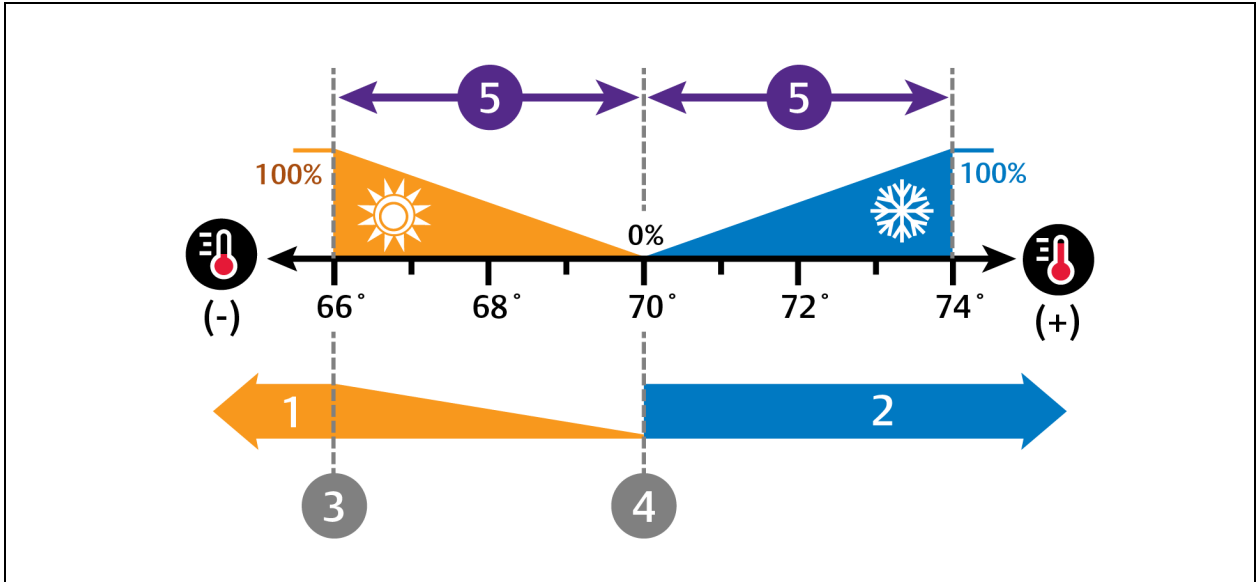



No.	Description	No.	Description
1	SCR reheat operation.	4	SCR reheat stops/begins operating at the setpoint.
2	Compressor operation.	5	½ of proportional band.
3	SCR reheat output is 100%.		

3.2.8 Setting Humidifier Options

The type of humidifier used depends on the cooling unit model and application requirements for your system.

NOTE: Except for externally mounted humidifiers, humidifier operation is limited by the return air temperature. If return air temperature reaches 80°F (26°C) or higher, the humidifier is disabled. The humidifier will not resume operation until the temperature falls to 75°F (24°C) or remains below 80°F (26°C) for 20 minutes.

1. Touch , then  > *Options Setup* > *Humidifier Settings*. The HUMIDIFIER SETTINGS panel displays.
2. Make adjustments as needed and click *Save*. The option settings are updated.
 - Touch *Cancel* to discard the changes without saving.

NOTE: Depending on the type of thermal management unit, included components, and control settings of your system, all of the options listed may not be available on your Vertiv™ Liebert® iCOM™ display.

Humidifier Settings Options

Humidification System Enabled



Enables/disables group wide (network wide) humidification by the cooling units in the group. Once enabled at the system level, individual units may be enabled using the Humidification Enabled parameter.

Humidification Enabled

Enables/disables humidification at the unit level.

- On-Off: Sends a start-stop command to a remote-mounted humidifier.

3.2.9 Setting Dehumidification Options

1. Touch , then  > *Options Setup* > *Dehumidification Settings*. The DEHUMIDIFICATION SETTINGS panel displays.
2. Make adjustments as needed and click *Save*. The option settings are updated.
 - Touch *Cancel* to discard the changes without saving.

NOTE: Depending on the type of thermal management unit, included components, and control settings of your system, all of the options listed may not be available on your Vertiv™ Liebert® iCOM™ display.

Dehumidification Settings Options



Dehum System Enabled

Enables/disables whether or not the compressor/valve is used for dehumidification when humidity is above the setpoint.

Dehum Unit Enabled

Enables/disables dehumidification for the cooling unit.

3.2.10 Setting Q15 Options

1. Touch , then  > *Options Setup* > *Q15 Settings*. The Q15 SETTINGS panel displays.
2. Make adjustments as needed and click *Save*. The option settings are updated.
 - Touch *Cancel* to discard the changes without saving.

Q15 Settings Options

Q15 Output Direction

Selects whether the output is normally on or normally off.

Q15 Output Function

Selects the reason for which the digital output is activated. Options are:

- 1: Dehum On
- 3: Reheat On
- 4: Comp On
- 5: Comp 1 On
- 6: Comp 2 On
- 7: Humi On
- 9: Free Cool On
- 10: Damper
- 11: High Temp
- 12: Low Temp

Q15 Output Sensor

Selects a sensor reading to compare to the set threshold that activates Q15 output. Options are:

- 0: Return
- 2: Rem Max
- 3: Rem Low
- 4: Rem Avg

Q15 Output State

Status of Q15 output, ON or OFF.

Q15 Temp Actual

Current value of the sensor selected as the Q15 Output Sensor.

Q15 Temp Output Threshold

Temperature threshold above or below which Q15 output activates.

This page intentionally left blank

4 Managing Events: Alarms, Warnings and Messages

Events are notifications of operating status for the cooling unit, its components, and auxiliary devices. All events are recorded in the Event Log, and alarm and warning events are also displayed on the Alarms panel (See [Viewing the Event Log](#) on page 19 , and [Viewing Unit Alarms](#) on page 16 .)

In some cases, depending on configuration, an alarm event may power off the cooling unit, but not always. However, if a standby unit is configured, all alarm events stop the faulty unit and start the standby unit. Message and warning events do not.

4.1 Event Properties

The ALARMS & EVENTS panel lists all events available on the system. You can view and modify events and the criteria that trigger visual/audible alarms including:

- Critical thresholds
- Time delays
- Enable/disable
- Event type
- Adding custom events

NOTE: Not all event properties may be adjusted, depending on the criticality of the event, which is factory set.

4.1.1 To Open the Panel

Touch , then  > Alarm/Event Setup.

NOTE: Depending on the type of thermal management unit, included components, and control settings of your system, all of the options listed may not be available on your Vertiv™ Liebert® iCOM™ display.

Alarms and Events Panel Fields

Property

Lists groups of events, expanding displays the events in each group. See [Enabling Events and Editing Event Settings](#) on the next page .

Type

Event type. See [Selecting Event Type and Setting Alarm/Warning Notification](#) on page 55 .

Ack

Indicates type of acknowledgment required. See [Acknowledging Alarms](#) on page 18 . This option is not available with all alarm types.

- Auto: The alarm is acknowledged automatically. It goes away if the situation that triggered alarm event is no longer true.
- Manual: The alarm goes away only when acknowledged, even if the situation that triggered the alarm event is resolved/no longer true.

Reset



Indicates type of reset required for the event.

- Auto: The alarm resets automatically after acknowledgment.
- Manual: The alarm must be reset manually after acknowledgment. See [Acknowledging Alarms](#) on page 18 .

This option is not available with all alarm types.

4.2 Enabling Events and Editing Event Settings

In the ALARMS & EVENTS panel, events are grouped into categories for easier management, for example, the factory set remote sensor alarms and humidification/dehumidification events. In some cases, touch the group heading provides edit options for the entire group, like thresholds, delays and enable/disable. Each event includes settings specific for that event and the notification option where event-type and alarm notifications are selected (See [Selecting Event Type and Setting Alarm/Warning Notification](#) on the facing page).

1. Touch , then  > *Alarm/Event Setup*. The ALARMS & EVENTS panel opens.
2. Scroll or search to find the event, touch the set's heading to display the properties and values for the entire set in the EDIT panel.
– or –
Touch an individual alarm or event to display it's specific values in the EDIT panel.

NOTE: To edit the event type and notification, see [Selecting Event Type and Setting Alarm/Warning Notification](#) on the facing page .

3. Use the EDIT panel to adjust the settings for the selected event or group of events.



4.3 Selecting Event Type and Setting Alarm/Warning Notification

Setting notification delays and disabling visual notification prevents nuisance notifications. Customize to notify of critical events on your cooling system.

NOTE: If the event includes a safety function, such as high pressure, low pressure, main fan overload, etc., the safety function executes regardless of event type or notification setting. However, notification timing delays still apply.

Table 4.2 on page 57, lists the default and adjustable notification settings for events.

4.3.1 To Select Event Type and Notification

1. Touch , then  > *Alarm/Event Setup*.
2. Scroll or search to find the event and touch the alarm or event.
3. On the EDIT panel, touch *Notifications*. The EDIT panel displays the notification properties.
4. Adjust the notification properties described in the [Notification Properties](#) below, then touch Save. The notification is updated.
 - Touch *Cancel* to discard the changes without saving.

Notification Properties

Delay

Time, in seconds, to delay notification after event trigger. Depending on the event, the delay may or may not be adjusted. **Table 4.2** on page 57, lists the delays and their default settings.

- If the notification delay for the event is greater than the delay set for the event group, the group's delay includes the event's delay.

Enable

Enables/disables notification. Touch the switch to set On or Off.

- When disabled, events are not logged or displayed, and visual and audible alarm notifications are not made.

Type

Logging and notification level of the event. **Table 4.1** below, describes the event type and notification it generates. **Table 4.2** on page 57, lists the default types for events.

Table 4.1 Notification Types

Type	Description
Message	Stored in event log only. No visual or audible notification.
Warning	Listed with a yellow status dot on the ALARMS panel and the LED flashes. See Table 10.1 on page 119, and Viewing Unit Alarms on page 16.
Alarm	Listed with a red status dot on the ALARMS panel, the LED flashes, and the audible alarm sounds. See Table 10.1 on page 119, Viewing Unit Alarms on page 16, and Enabling the Audible Alarm Notification on page 59.

Table 4.2 on the facing page , lists the default settings for each event.

- Internal delay is factory set and not adjustable. It is the time delay after event trigger that notification is sent.
- Default delay may or may not be adjustable and is added to the internal delay of event notification.
- Type may be adjustable or may be fixed.

NOTE: Depending on customization, some events may not be available on your cooling unit.



Table 4.2 Event Notification Defaults

Event	Internal Delay	Default Delay/Range for Adjustment	Type
MAIN FAN OVERLOAD	2 sec	5 sec/0 – 9999 *	ALM
LOSS OF AIRFLOW	3 sec	3 sec/0 – 9999 *	ALM
CLOGGED FILTERS	2 sec	2 sec/0 – 9999 *	WRN
HIGH ROOM TEMP	1 min. after fan on	30 sec/0 – 9999	Fixed to WRN
LOW ROOM TEMP	1 min. after fan on	30 sec/0 – 9999	Fixed to WRN
HIGH ROOM HUM	1 min. after fan on	30 sec/0 – 9999	Fixed to WRN
LOW ROOM HUM	1 min. after fan on	30 sec/0 – 9999	Fixed to WRN
HIGH TEMP SENSOR A	1 min. after fan on	30 sec/0 – 9999	Fixed to WRN
LOW TEMP SENSOR A	1 min. after fan on	30 sec/0 – 9999	Fixed to WRN
HIGH HUM SENSOR A	1 min. after fan on	30 sec/0 – 9999	Fixed to WRN
LOW HUM SENSOR A	1 min. after fan on	30 sec/0 – 9999	Fixed to WRN
COMP 1 OVERLOAD	Internal Calc.	no	ALM
COMP 1 HIGH PRESSURE	Internal Calc.	no	ALM
COMP 1 LOW PRESSURE	Internal Calc.	no	ALM
DIG SCROLL1 HIGH TEMP	Internal Calc.	no	ALM
EL HEAT HIGH TEMP	5 sec	0 sec/0 – 9999	WRN
WORKING HRS EXCEEDED	0 sec	0 sec/0 – 9999	Fixed to WRN
SMOKE DETECTED	2 sec	2 sec/0 – 9999 *	ALM
WATER UNDER FLOOR	2 sec	2 sec/0 – 9999 *	ALM
COND PUMP-HIGH WATER	2 sec	2 sec/0 – 9999 *	ALM
LOSS OF FLOW	5 sec Reset delay: 10 sec	2 sec/0 – 9999 *	ALM
STBY GLYCOL PUMP ON	2 sec	2 sec/0 – 9999 *	ALM
STANDBY UNIT ON	2 sec	2 sec/0 – 9999 *	ALM
HUMIDIFIER PROBLEM	2 sec	2 sec/0 – 9999 *	ALM
NO CONNECTION w/Unit1	Internal Calc.	-	WRN
UNIT X DISCONNECTED	Internal Calc.	-	WRN
LOSS OF POWER	0 sec	no	ALM
CUSTOMER INPUT 1	2 sec	2 sec/0 – 9999 *	ALM
CUSTOMER INPUT 2	2 sec	2 sec/0 – 9999 *	ALM
CUSTOMER INPUT 3	2 sec	2 sec/0 – 9999 *	ALM
CUSTOMER INPUT 4	2 sec	2 sec/0 – 9999 *	ALM
CALL SERVICE	2 sec	2 sec/0 – 9999 *	MSG

Table 4.2 Event Notification Defaults (continued)

Event	Internal Delay	Default Delay/Range for Adjustment	Type
HIGH TEMPERATURE	2 sec	2 sec/0 – 9999 *	MSG
LOSS OF AIR BLOWER 1	2 sec	2 sec/0 – 9999 *	ALM
REHEAT LOCKOUT	2 sec	2 sec/0 – 9999 *	WRN
HUMIDIFIER LOCKOUT	2 sec	2 sec/0 – 9999 *	WRN
FC LOCKOUT	2 sec	2 sec/0 – 9999 *	WRN
COMPRESSOR(S) LOCKOUT	2 sec	2 sec/0 – 9999 *	WRN
COMP 1 SHORT CYCLE	0 sec	0 – 9999	MSG
No Power	0 sec	0 sec/0 – 9999WRN	
Condensate 1 Failure	0 sec	5 sec/0 – 9999	WRN
Condensate 2 Failure	0 sec	5 sec/0 – 9999	WRN
EC Fan Fault	0 sec	10 sec/0 – 9999	ALM
HIGH SUP TEMP	0 sec	30 sec/0 – 9999	WRN
LOW SUP TEMP	0 sec	30 sec/0 – 9999	ALM
REDUCED ECO AIRFLOW	0 sec	3 sec/0 – 9999	WRN
ECO HI TEMP OVERRIDE	0 sec	10 sec/0 – 9999	WRN
TEMP CTRL SENSOR FAIL	0 sec	3 sec/0 – 99999	ALM
HIGH DEW POINT	0 sec	30 sec/0 – 9999	WRN
LOW DEW POINT	0 sec	30 sec/0 – 9999	WRN
HI DEW POINT SENSOR A	0 sec	30 sec/0 – 9999	WRN
LOW DEW POINT SENSOR A	0 sec	30 sec/0 – 9999	WRN
HIGH REMOTE SENSOR	0 sec	30 sec/0 – 9999	WRN
POWER "A" FAILURE	0 sec	10 sec/0 – 9999	ALM
POWER "B" FAILURE	0 sec	10 sec/0 – 9999	ALM
AIRFLOW SENSOR FAILURE	0 sec	10 sec/0 – 9999	WRN
HUM CTRL SENSOR FAIL	0 sec	30 sec/0 – 9999	WRN
LOSS OF FLOW	0 sec	5 sec/0 – 9999	ALM
DAMPER FAILURE	0 sec	10 sec/0 – 9999	ALM
BMS DISCONNECTED	0 sec	ENABLED/DIS - ENAB	WRN

4.4 Enabling the Audible Alarm Notification

1. Touch , then  > *Display Options* > *Display Properties*. The UNIT DISPLAY panel opens.
2. Touch the *Alarm Buzzer Pattern* value, and select a pattern from the drop-down list.
 - Selecting *None* disables the audible notification.
3. Touch *Save* to save the property settings.
 - Touch *Cancel* to discard changes.

4.5 Remote Alarm Device and Customer Input Events

Remote alarm devices are various sensors and detectors outside the cooling unit that provide information about conditions and situations that may affect operation. Remote alarm devices include smoke detectors, filter condition, valve status.

Included in the remote alarm devices option are up to three customer input events, depending upon the cooling unit configuration. See [Setting Up Customer Input Events](#) below .



Remote alarm device and customer input notifications are set in the same way as other events. See [Selecting Event Type and Setting Alarm/Warning Notification](#) on page 55 .

4.5.1 Setting Up Customer Input Events

Input devices must be wired to Terminal 24 through a dry contact to locations 50, 51 and 56 for alarms 1 through 3, respectively. (For the terminal location, refer to the cooling unit electrical schematic and installation manual). **Table 4.3** below , maps the customer input to the remote alarm device.

Table 4.3 Customer Input Terminals to Remote Alarm Device Terminals

Customer Input	Customer Input Terminal	RAD Number	RAD Terminal
1	24	1	50
2	24	2	51
3	24	3	56
4	24	4	56

1. Touch , then  > *Alarm/Event Setup* > *Remote Alarm Device Input*. The EDIT panel opens.
2. In *Customer Input X* (where *X* is the input number), select the input type that best describes the wired device/input, see **Table 4.4** on the next page .
3. In *Customer Input X Active When*, select whether the input is active (triggers events) when opened or closed.
4. Once input(s) are set, touch *Save*. The customer input settings are saved.

Customer Input Options

Customer Input X

Selects the customer wired input, where X is the input number. See [Customer Input Options](#) below, for a description of available values.

Customer Input X Active When

Selects when the input triggers an event. Options are:

- Opened: Events are triggered when the contacts across the corresponding remote alarm device terminal strip are open.
- Closed: Events are triggered when the contacts across the corresponding remote alarm device terminal strip are closed.

NOTE: Depending on customization, some events listed in Table 4.4 below, may not be available with your system.

Table 4.4 Customer Input Options

Input	Action/Description
Smoke	Event only.
Water Alarm	Event only.
C PMP Alarm	Event only.
Flow Alarm	Event only.
Stdby G Pmp	Event only.
Stdby Unit	Event only.
C-Input 1	Event only.
C-Input 2	Event only.
C-Input 3	Event only.
C-Input 4	Event only.
Rht Lockout	Event + Electric heaters disabled.
Hum Lockout	Event + Humidifier disabled.
Rht+Hum Lock	Event + Electric heaters and humidifier disabled.
Comp Lockout	Event + Compressor(s) disabled without pump down.
Call Service	Event only.
High Temp	Event only.
HTRJ VFD	Activates the HEAT REJ VFD ALARM. No other function.
HTRJ SPD	Activates the HEAT REJ SPD ALARM. No other function.
FIRE ALARM	Event + Shuts down the unit.
2ND SETPOINT	No event, but switches to the second setpoint.
Emergency Power	Event + Disables unit.

Table 4.4 Customer Input Options (continued)

Input	Action/Description
LSI	Event + Activates humidifier problem alarm and stop filling bottle when full.
COND 1 FAIL	Event only.
D-SCROLL RED	Event + Reduces requested compressor capacity by 20%.
SWAP VALVE	No event -Active X valve closes and Y opens/Inactive Y closes and X opens.
EC FAN FAULT	Event + Set analog output to 10 V.
ECO AIRFLOW	Event + Reduce Liebert® air economize air flow.
DAMPERSWITCH	Damper + End switch.
POWER A	Event only.
POWER B	Event only.

This page intentionally left blank

5 Unit to Unit (U2U) Networking

Vertiv™ Liebert® iCOM™ controlled thermal management units connected in an Ethernet unit to unit (U2U) network are able to efficiently cool and control humidity in the conditioned space by exchanging data in several modes of operation.

U2U networking is required to set up and control the following operating features:

- Teamwork
- Standby (lead/lag)
- Rotation
- Cascading

NOTE: The U2U network must be separate from other networks. Use Liebert Embedded Unity to communicate securely between your building management system or other networks.

5.1 Preparing for U2U Group Set Up

Cooling units in the network will be assigned to groups, which affects how units function in teamwork, standby, rotation, and cascading operations. Especially in large rooms, it is important to consider several factors before setting up groups to balance cooling unit operation with room conditions.

NOTE: For ease of set up and use, we recommend using only one group unless you have multiple rooms, differing software versions, or different types of cooling units.

1. Make a map of the room and indicate the location of all heat generating devices and cooling units to plan for proper heat load management and cooling air distribution.
2. Note the type of units by product, model, size, etc.
3. Determine the number of units to network together to ensure proper air flow and environmental control, up to 32 units.
4. Determine number of standby units.
5. Determine if using teamwork, and if so, which mode.
6. Plan U2U address assignments.
 - Refer to the [U2U Control Board Settings](#) on page 65, for guidelines assigning cooling unit control board addresses.
 - Balance/alternate unit address assignments based on room layout and because standby and teamwork operate in numeric order by unit number. **Figure 5.1** on the next page, shows an example layout assignment with half of the cooling units in standby and half operating. Without a plan, adjacent units could be operating or inactive, which may not provide proper heat load balance or efficient use of cooling capacity.
7. Read and record all programmed settings for each of the individual units (see [Backing Up and Restoring Control Board Settings](#) on page 117).
8. Verify that network cabling and switches are provided, ready to connect, and labeled by unit at the network switch.

NOTE: Cooling units are factory wired for stand alone operation. Do not connect the U2U network cabling before setting the U2U network configuration/groups. Network communication conflicts and unreliable display readings will result. Configure the network using [Configuring U2U Network Settings](#) on the next page, then refer to [U2U Wiring Connections](#) on page 139, to connect the network cabling and hardware.

Figure 5.1 Example Layout Standby/Operating Unit Address Assignment

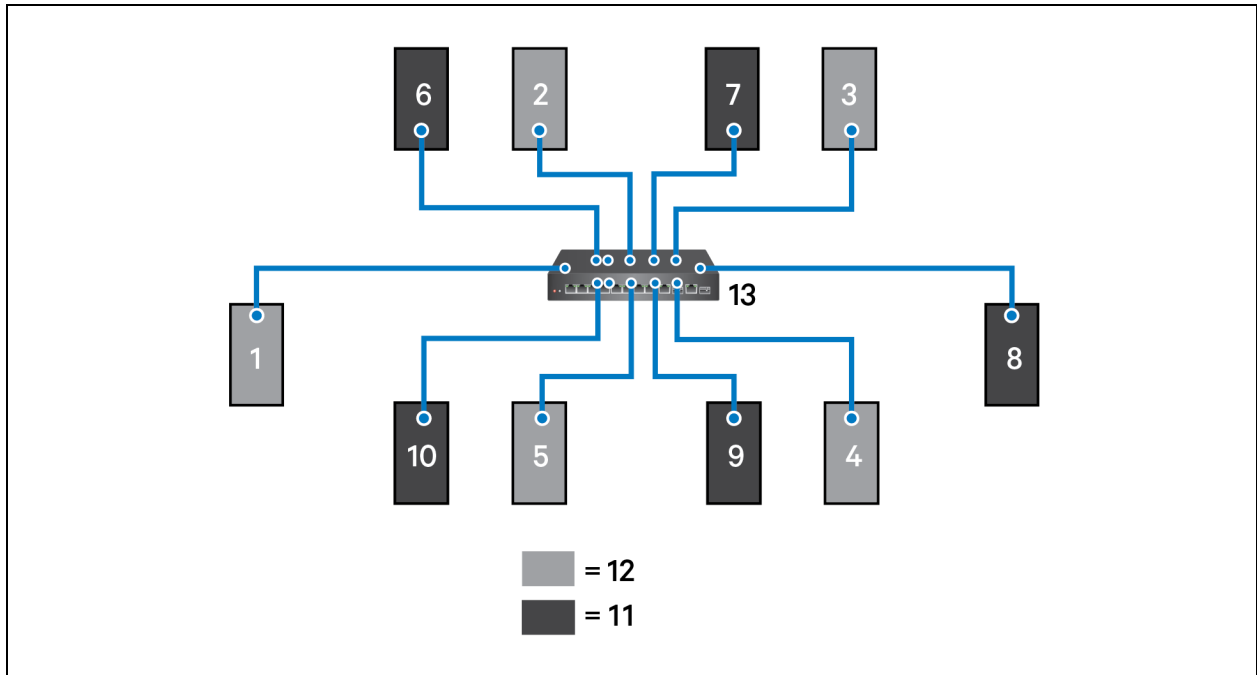

Item	Description
1 to 10	Assigned address of the thermal management unit.
11	Operating units.
12	Units on standby
13	Network switch

5.2 Configuring U2U Network Settings

The U2U NETWORK SETTINGS configure Vertiv™ Liebert® iCOM™'s unit to unit communication and includes

information buttons, , that display popup field descriptions. The panel also indicates issues with the network settings. For resolution, see [Troubleshooting Network Settings Issues](#) on page 66 .

5.2.1 To Configure U2U Networking

1. Touch , then  > *BMS & Teamwork Setup* > *U2U Setup*. The U2U NETWORK SETTINGS panel opens.
2. Touch the field to edit. The keypad opens.

3. Type the entry and touch .
4. When all fields to edit are updated, touch *Save & Restart*.

NOTE: Depending on the changes made, the *Save* button updates to indicate the components that need rebooted or restarted. If the control board reboots, the cooling unit suspends operation for 60 seconds, then resumes operating.

U2U Control Board Settings

Broadcast

Logical address at which connected units receive datagrams.

NOTE: Messages sent to the broadcast address is typically received by all network attached hosts.

CB Firmware Version

Display configuration based on the firmware version of the control board. Depends on your cooling unit as follows:

- PA-2.06 = CW/DS, DSE, PDX/PCW, Mini-Mate

Gateway

Routes data and acts as proxy server/firewall for control board during network set-up. Display and control-board must be identical on the U2U network.

IP Address

Network address of the control board.

NOTE: The last three digits must be a unique value and need not be sequential. However, we recommend that they match the U2U address for easier reference later.

Netmask

Divides IP addresses in subnet and specifies network available to hosts for the control board.

MAC Address

Unique, read-only identifier of the control board Ethernet device.

U2U Address

Unique identifier for each control board on the U2U network. Address range is 1 to 32 and must be consecutive from the previous control-board address in the U2U group. This is the address used for standby/lead lag and cascade operation, see **Figure 5.1** on the previous page.

NOTE: We recommend matching the U2U address to the last three digits of the IP address for easier reference later.

U2U Group

For the control board, selects the zone/group with which the unit will be configured in teamwork/standby/rotation scenarios.

NOTE: Units with a specific thermal area of influence should be assigned to the same zone/group, typically when a network spans separate rooms rather than by aisles. Groups are also handy when cooling units vary by cooling type, compressor type, or version of Vertiv™ Liebert® iCOM™ firmware and otherwise do not operate together efficiently or at all.

5.2.2 Troubleshooting Network Settings Issues

At the bottom of the U2U NETWORK SETTINGS panel, an Issues button indicates whether or not there are problems with the network settings. The button indicates the number of issues and changes color when a problem exists, see **Table 5.1** below .

Table 5.1 Issues Button Status Colors



Color	Description
Green	No problems. Number of issues is zero.
Red	Problem(s) detected. Number of issues displays.

To View Network Issues

1. When an issue is indicated, touch the Issues button on the U2U NETWORK SETTINGS panel. The ISSUES dialog opens.
2. Note the problems, close the dialog, then address the issue:
 - Touch the setting to correct. The onscreen keyboard opens.
 - Make adjustments and touch Go.
 - Continue making corrections until no problems are indicated.
3. Verify that U2U communication is established, then touch Save.

NOTE: Depending on the changes made, the Save button updates to indicate the components that need to be rebooted or restarted. If the control board reboots, the cooling unit suspends operation for 60 seconds, then resumes operating.

5.2.3 Modifying U2U Network Settings

1. Touch  , then  > *BMS & Teamwork Setup > U2U Setup*. The U2U NETWORK SETTINGS panel opens.
2. Touch the setting to edit and make adjustments, then touch .
3. Verify that U2U communication is established, then touch Save.

NOTE: Depending on the changes made, the Save button updates to indicate the components that need to be rebooted or restarted. If the control board reboots, the cooling unit suspends operation for 60 seconds, then resumes operating.

6 Teamwork, Standby, and Rotation for Cooling Units

Vertiv™ Liebert® iCOM™ U2U communication via private network and additional hardware (see [Unit to Unit \(U2U\) Networking](#) on page 63) allows the following operating features for the cooling units:

- Teamwork
- Standby (Rotation)
- Cascade

6.1 Continuous Control with Virtual Master

The Virtual Master function maintains smooth control if group communication is compromised. In these operating configurations, a lead (master) unit is in charge of component staging in teamwork mode, unit staging, and standby rotation. If the lead unit gets disconnected, Liebert® iCOM™ automatically assigns a virtual master, which assumes the responsibilities of the lead unit until communication is restored.



6.2 Teamwork Modes

When Liebert® iCOM™ controlled thermal management units are connected to a network in a group or team, use teamwork to optimize performance and efficiency depending on the mode chosen and its application.

In a panel with Status content, the Teamwork mode icon indicates the mode selected, **Figure 6.1** on the next page . Touching the icon displays the Teamwork dialog from which you can access the teamwork control settings.

6.2.1 To Set Up Team Work

1. Touch the Teamwork mode icon, then touch *Edit* on the teamwork dialog.
– or –

Touch  , then  > *BMS & Teamwork Setup* > *Teamwork / Standby* > *TeamworkMode*.

2. Select the mode from the *Teamwork Mode* drop down in the TEAMWORK MODE CONTROL panel. The TEAMWORK/STANDBY panel opens.
3. Touch *Save*. Teamwork mode is set.
 - Touch *Cancel* to discard changes.

Figure 6.1 Teamwork Icons

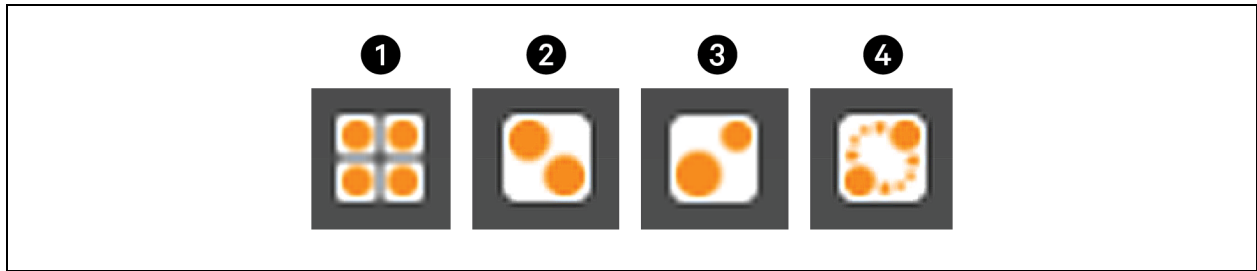

Item	Description
1	No teamwork.
2	Mode 1 - Parallel teamwork
3	Mode 2 - Independent teamwork
4	Mode 3 - Optimized aisle teamwork NOTE: Not applicable to Liebert® Mini-Mate units.

NOTE: Depending on the type of thermal management unit, included components, and control settings of your system, all of the options listed may not be available on your Vertiv™ Liebert® iCOM™ display.

Teamwork Control Options

Cascade Units

Stages on standby units based on room temperature/humidity load. Available in Teamwork mode 1:

- Teamwork mode 1 Parallel options are:
 - Yes: standby units cascade on, based on a call for heating, cooling, humidification, or dehumidification.
 - Cool/Heat: Standby units cascade on with a call for heating or cooling only.
 - Cooling: Standby units cascade on with a call for cooling only.

Cascaded Units Delay

Length of time in minutes to delay the activation of a standby unit after the previously activated unit starts, to prevent staged cascaded units from starting too close together or at the same time.

Cascaded Units Min Run

Length of time in minutes that an cascade on unit must run before powering off.

Cascaded Units Off Delay

Length of time, in minutes, to delay powering off a cascaded unit after fan speed drops below the *Stop Next Unit at SYS Fanspeed* setting.

Cascaded Units Quick Start

After a power cycle of the master unit, identical to Cascaded Units Delay except that it should be shorter to get units to start more quickly after a power cycle.

- This delay remains in effect until all cascaded units have been restarted, then the delay reverts to setting of Cascaded Units Delay.

Max. Intermediate System Speed

Limits the fan speed of the group until all units in cascade are powered on. Once all units are operating, the fan speed may increase beyond this setting.

Number of Connected Units

Number of units connected in the group if U2U networked.

Start Next Unit at SYS Fan Speed

Fan speed at which the next cascaded unit is powered on.

Stop Next Unit at SYS Fan Speed

Fan speed at which the next cascaded unit is powered off. Unit power off may be delayed by *Cascaded Units Off Delay*.

Based On

Select the way the sensor readings from each cooling unit in the group are used to control temperature and humidity. Options are:

- Maximum: Based on the highest reading from a sensor in the group.
- Average: Based on the average readings from the sensors in the group.

Type

Teamwork mode to use for the group.

6.2.2 No Teamwork—Multiple Zones in One Room

When a teamwork mode is not used, cooling units work independently based on their own sensors. Standby and unit rotation may be used, but cascading cannot.

6.2.3 Teamwork Mode 1—Parallel Operation

In Teamwork Mode 1, fan speed and cooling capacity are ramped up in parallel, which means that all units operate identically.

Teamwork Mode 1 is best for small rooms with balanced heat loads. A master unit collects the controlling readings for temperature and humidity from all the operating (fan on) units in the group, then determines the average or worst case reading, and sends operating instructions to efficiently distribute cooling capacity across available units.

In Teamwork Mode 1, most parameters are shared and, when set in any unit, are set in all units in the group.

6.2.4 Teamwork Mode 2—Independent Operation

Teamwork Mode 2 works well for most applications, and best in large rooms with unbalanced heat loads by preventing units in a group from operating in opposing modes, some cooling and some heating. All temperature and humidity parameters are shared by the group. The master unit monitors all available unit sensor readings and determines the demand for cooling, heating, humidification and dehumidification, then sends operating instructions to address the greatest demand.

In Teamwork Mode 2, the setpoints for all units must be identical. The proportional band, deadband, and related settings may differ by unit. Fan speed is modulated per unit. Rotation and cascading is not available, so expect uneven distribution of work hours.

6.3 Assigning Cooling Units to Standby (Lead/Lag)

Standby assigns some units to operate while others are on standby, meaning a unit is idle but ready to become active in the event of an alarm condition in one of the operating units or based on a rotation schedule.

When a unit is in standby mode, fan(s) are off and no cooling occurs. In multiple cooling unit systems, assigning units to standby lets you:



- Configure redundancy in case of failure scenarios (stand by).
- Manage cooling unit run time (lead/lag). See [Setting a Rotation Schedule](#) on the facing page .
- Modulate for very low loads to full design load (to be temperature reactive) by cascading activation of standby units (configured when setting up teamwork mode).

The U2U network has built-in fail over conditions that are automatically employed when standby units have been assigned:

- During single cooling unit or component failure, a standby unit is activated to replace the failed unit.
- Alarm event causes unit shut down, a standby unit is activated. If the activated unit also has an alarm event, the next available standby unit is activated. If all units have an alarm event, and no more standby units are available, a unit with a non-critical alarm event will be activated.

NOTE: Redundancy is employed if units are assigned to standby regardless of the teamwork mode selected, including No Teamwork.

6.3.1 To Set Up Lead/Lag Operation

1. Touch , then  > *BMS & Teamwork Setup* > *Teamwork / Standby*. The TEAMWORK/STANDBY panel opens.
2. Touch *Standby*. The STANDBY CONTROL panel displays.
3. Adjust the settings, then touch *Save*.
 - Touch *Cancel* to discard the changes.

Standby Options

High Temperature Threshold

Temperature at which all standby units are activated.

Number of Standby Units

Number of units in standby mode.

Standby Fan Timer at Reheat/Humidification



Length of time in minutes that the fan continues to operate after the cooling unit enters standby mode if reheat or the humidifier were operating when unit powered off.

Start All Standby Units by High Temperature

When enabled, all units are activated to cool when a high temperature alarm occurs.

6.4 Setting a Rotation Schedule

You can set a rotation schedule to switch operating and standby units to manage run time of the cooling units.

1. Touch , then  > *BMS & Teamwork Setup* > *Teamwork / Standby*. The TEAMWORK/STANDBY panel opens.
2. Touch *Unit Rotation*. The UNIT ROTATION CONTROL panel displays.
3. Adjust the settings, then touch *Save*. Touch *Cancel* to discard the changes.

6.4.1 Unit Rotation Options

Lead Lag Overlap Timer

Length of time in minutes that cooling units operate in parallel when one begins operating (from standby) and the other goes into standby.

Rotate At

Selects exact time at which rotation occurs. Adjustable, based on 24 hour clock where minutes are 0 to 59 and hours are 0 to 23.

Rotate By

Number of positions by which the cooling units rotate. For example, rotate by three in a group of 10 units and start with unit 1 operating. At rotation, unit 1 goes to standby and unit 4 activates, then 7, 10, 2, and so on. You can select one to eight units in a single rotation schedule.

Rotate Every

Selects rotation period. Valid values are:

- 12 hours
- 24 hours

Rotate Now

Immediately performs rotation.

Rotation Frequency

Frequency at which rotation occurs. Options include:

- No: Rotation disabled.
- Daily: Rotation occurs every day.
- Every [Day of Week]: Rotation occurs weekly on the same day.
- Monthly [Day of Week]: Rotation occurs monthly on the same day.



6.4.2 Manually Rotating the Operating and Standby Units

You can rotate the operating and standby units outside of the set schedule using Rotate Now.

NOTE: Manual rotation may only be performed at the cooling unit designated as the lead unit—U2U Address is 1 of the group.



NOTE: The Rotate Now button may only be available when a Rotation Frequency is selected. See [Setting a Rotation Schedule](#) on the previous page .

1. At the cooling unit, verify that it is the lead unit of the group:

- Touch , then  > *BMS & Teamwork Setup > U2U Setup*.
- In the CONTROL BOARD column, verify that the *U2U Address* is 1.

If it is the lead unit, continue with step 2 .

If it is not the lead unit, find the lead unit and start at step 1 .

2. Touch , then  > *BMS & Teamwork Setup > Teamwork / Standby*. The TEAMWORK/STANDBY panel opens.
3. Touch *Unit Rotation*. The UNIT ROTATION CONTROL panel displays.
4. Touch *Rotate Now*, then touch *Save*. The operating and standby units are rotated.

7 External Monitoring and Building Management Systems

Vertiv™ Liebert® iCOM™ controlled cooling units are equipped with embedded Vertiv™ Liebert® IS-UNITY-DP software to communicate with external monitoring systems including Building Management Systems (BMS), Network Monitoring Systems (NMS) and Vertiv™ Liebert® SiteScan™ Web.

Embedded Unity communicates with multiple third-party protocols to monitor and manage a range of parameters and events. The Embedded Unity software delivers:

- Velocity Protocol for Vertiv™ Liebert® *Trellis*™, Liebert® SiteScan™ Web and Vertiv™ Liebert® Nform™.
- Embedded Vertiv™ Liebert® LIFE™ Technology for Remote Service Delivery
- SNMP (v1/v2/v3) for NMS
- HTTP/HTTPS for web page viewing
- SMTP for e-mail
- SMS for mobile messaging
- Modbus RTU-Modbus Remote Terminal Unit communication protocol for BMS over an RS-485 serial network (Modbus RTU RS-485)
- Modbus TCP-Modbus Transmission Control Protocol for BMS over Internet or LAN.
- BACnet IP-BACnet over Internet Protocol for BMS over Internet or LAN.
- BACnet MSTP-BACnet Primary-Secondary/Token-Passing communication protocol for BMS over an RS-485 serial network (Modbus MSTP RS-485)

NOTE: Because the Liebert® iCOM™ U2U network must be separate from other networks, use external monitoring or BMS to communicate securely between networks.

7.1 BMS and IntelliSlot Settings

When communicating with a BMS with Liebert Embedded Unity, the BMS settings are identical and include:



- Disconnect failsafe
- Manual fan speed control
- Allowing the BMS to change fan speed
- Backup fan control

7.1.1 Configuring BMS Communication with Embedded Unity

By default, the built-in Unity function is disabled. You must enable communication with the BMS via the IS-UNITY options in Liebert® iCOM™.

To configure Modbus, BACnet, SNMP, SMS and HTTP communication, see [Communication Set Up with Embedded Unity](#) on page 75.

To Enable Embedded Unity Function

1. Touch , then  > *BMS & Teamwork* > *BMS Setup*. The BMS SETUP panel opens.
2. Select *IntelliSlot Card Settings* and one of the following in *Monitoring Protocol*:
 - *Embedded* to use built-in Unity function.

- *Embedded & IS V4* to use built-in Unity and additional Vertiv™ Liebert® IntelliSlot card or Vertiv™ Liebert® SiteLink connection.
3. Touch *Save & Restart (Unit Only)*.

IntelliSlot Options

Monitoring Address

Address used by Embedded Unity. Factory default is 3.

- Do not modify the monitoring address unless directed to do so by Vertiv technical support.



Monitoring Protocol

Protocols used for communication with BMS. Options are:

- Velocity V3: Legacy Velocity communication cards.
- IGM: IGMNet communication cards.
- Velocity V4: Vertiv™ Liebert® IS-UNITY card or Vertiv™ Liebert® Sitelink/Vertiv™ Liebert™ Sitescan™.
- Embedded: Embedded IS-UNITY functions.
- Embedded and IS V4: Both Embedded Unity function and Velocity V4 for an optionally installed Liebert® IS-UNITY card or Liebert® Sitelink/Liebert® Sitescan™.

7.1.2 Setting BMS Control Settings

NOTE: If a Liebert® Sitelink/Liebert® Sitescan™ Connection and MODBUS RTU or BACnet MSTP is required simultaneously, then the purchase of the RS-485 Expansion Board is required. Contact your local Vertiv sales rep or the factory.

1. Touch  then  > *BMS & Teamwork* > *BMS Setup* > *Control Settings*. The CONTROL SETTINGS secondary panel opens.
2. Adjust the settings, and touch *Save*. The settings are configured.

NOTE: Use Configure Timeout to configure the setpoints used in the event of an outage and BMS takes control. See [Setting BMS Backup Setpoints](#) on the facing page .

NOTE: Depending on the type of thermal management unit, included components, and control settings of your system, all of the options listed may not be available on your Vertiv™ Liebert® iCOM™ display.

BMS Control Settings Options

BMS is Connected To

- Velocity
- Analog Input 1-4

BMS Fan Speed Local Override

Enables/disables local override of the fa speed set via BMS.

Fan Control Sensor

Currently selected fan control sensor. Must be set to Manual for BMS control. See [Configuring Fan Setpoints](#) on page 36.



Handshake

Sets time period, in minutes, in which communication between the BMS and Liebert® iCOM™ must occur.

Maximum Fan Speed

Current fan speed setting (set via fan setpoints or by BMS).

7.1.3 Setting BMS Backup Setpoints

1. Touch , then  > *BMS & Teamwork* > *BMS Setup* > *Configure Timeout* button on the lower-right of the panel. The CONFIGURE TIMEOUT secondary panel opens.
2. Adjust the values, and touch *Save*. The settings are configured.

NOTE: Depending on the type of thermal management unit, included components, and control settings of your system, all of the options listed may not be available on your Vertiv™ Liebert® iCOM™ display.

BMS Timeout Settings Options

BMS Backup Fan Operation

Enables/disables BMS operation of the fans during backup operation. Options are:

- Disabled
- BMS Backup Spd
- Coupled
- BMS Backup Set

BMS Backup Temp Setpoint

Temperature that the cooling unit maintains during BMS backup operation.

7.2 Communication Set Up with Embedded Unity

The following sections describe the configuration options for embedded Unity function including Modbus, BACnet, SNMP, SMS, and HTTP communication.

NOTE: The Unity configuration is also accessible through the Unity web interface. For details on accessing and using the web interface, refer to the *Liebert® IntelliSlot Unity Card Installer/User Guide*, available at www.vertiv.com.

IS-UNITY Setup includes the following options to configure Unity function and communication:

- Connection
 - [Connecting to the BMS](#) below
 - [Embedded Unity User and Password](#) on page 80
 - [Troubleshooting Unity Connection and Setup](#) on page 78
- Configuration
 - [System Configuration](#) on page 81
 - [Local Users Configuration](#) on page 83
 - [Network Configuration](#) on page 84
 - [Web Server Configuration](#) on page 87
 - [Remote Services Configuration](#) on page 89
 - [Velocity Protocol Configuration](#) on page 91
 - [Messaging Configuration](#) on page 93
- Protocols
 - [BACnet Protocol Set Up](#) on page 97
 - [Modbus Protocol Set Up](#) on page 100
 - [SNMP Protocol Setup](#) on page 102
 - [Unity Status Readings](#) on page 107
 - [Unity Support Information](#) on page 107

7.2.1 Connecting to the BMS

The embedded Unity software resides on the Vertiv™ Liebert® iCOM™ control board. There are two methods of connecting to a BMS, via Ethernet or RS-485.

For a network connection, connect the Ethernet cable from the BMS to P74 on the Liebert® iCOM™ control board. **Figure 7.1** on the facing page, shows the connector location.

For an RS-485 connection, connect the serial cable from the BMS to TB3 on the Liebert® iCOM™ control board. Pin 1 is the positive terminal on the right in **Figure 7.1** on the facing page.

If the optional RS-485 Expansion Board is purchased, TB1 on the Expansion Board is then used for BACnet MSTP or MODBUS RTU and TB3 on the Vertiv™ Liebert® iCOM™ Board is used to connect directly to a Vertiv™ Liebert® Sitelink/Vertiv™ Liebert® SITESCAN™ System.

Figure 7.1 Control Board Connections

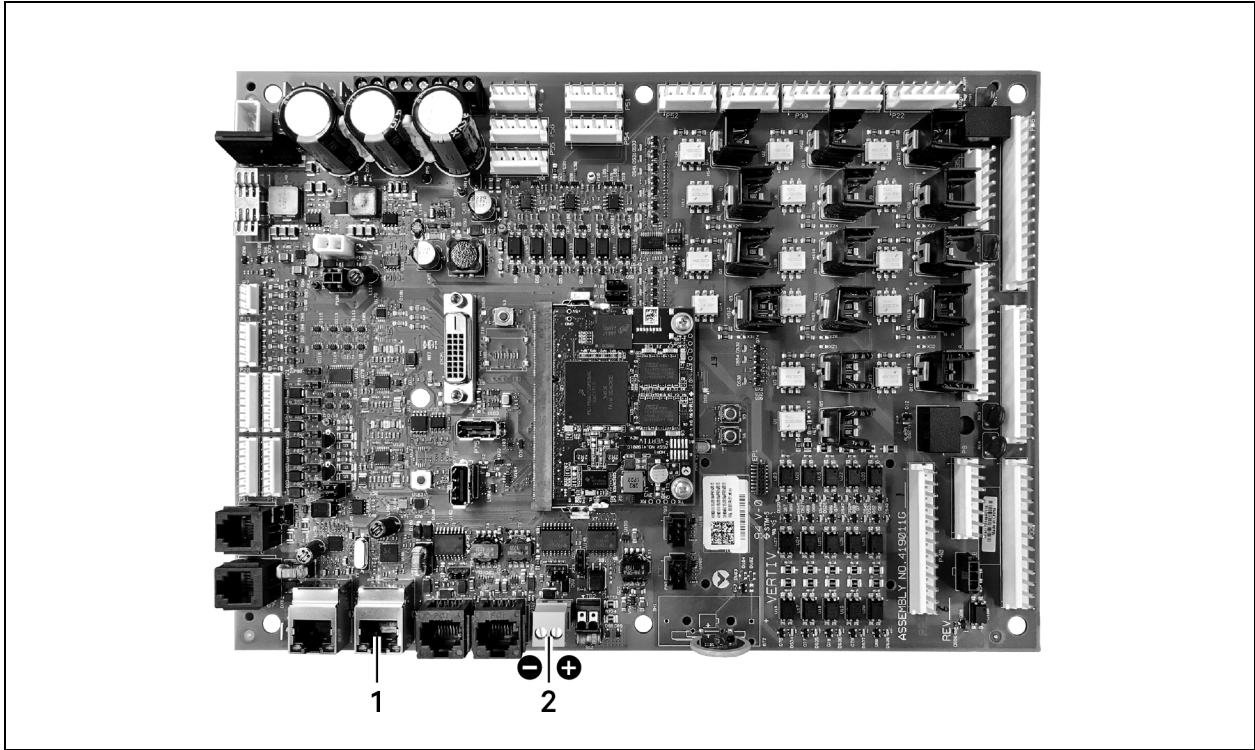

No.	Description
1	P74 Ethernet port
2	485 2 wire terminal connector

Troubleshooting Unity Connection and Setup

Figure 7.2 RS-85 Expansion Board

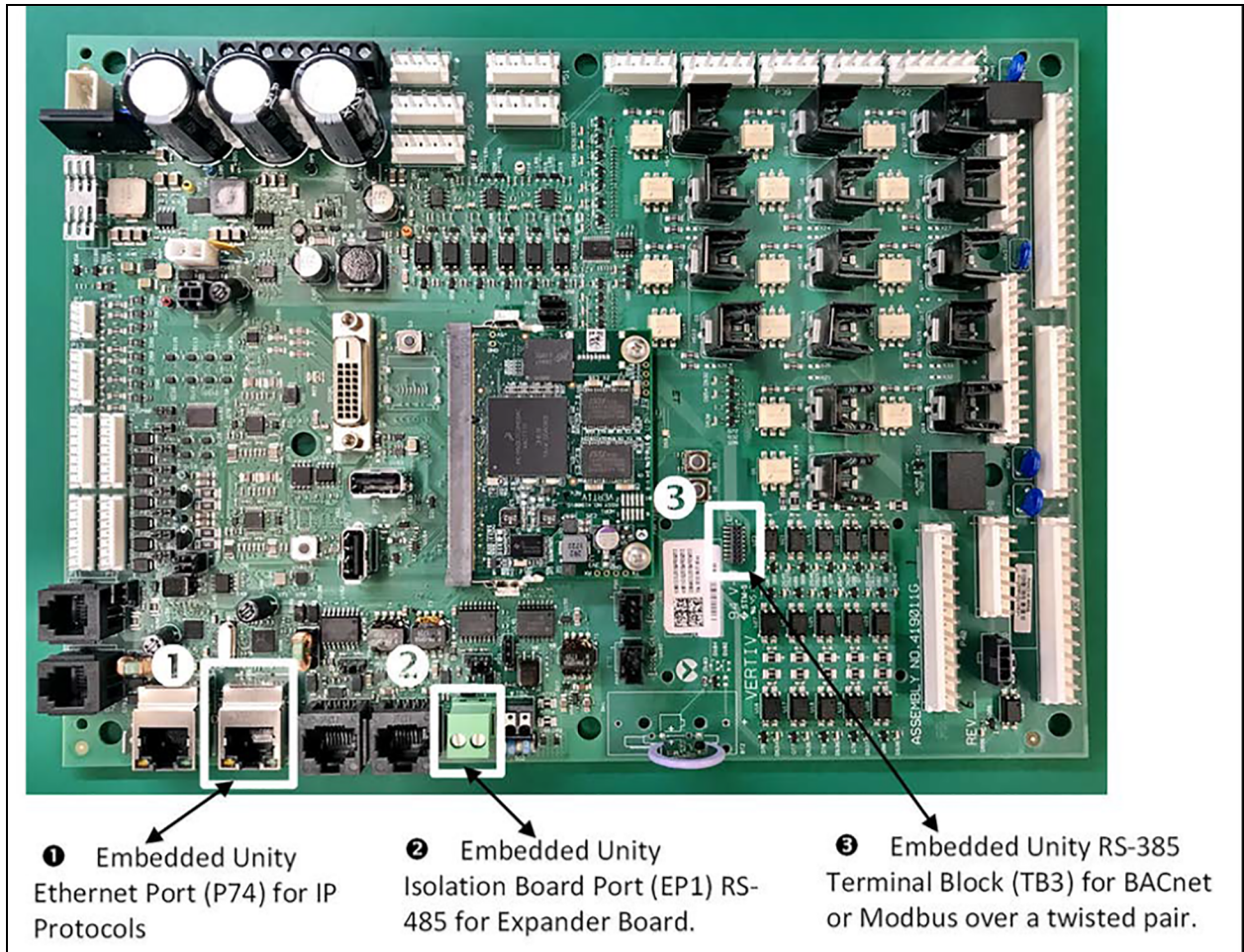

Item	Description
1	Embedded Unity Ethernet port (p74) for IP protocols
2	Embedded Unity RS-485 Terminal Block (TB3) for BACnet or Modbus over twisted pair
3	Embedded Unit isolation board port (EP1) RS-485 for expander board

The expansion board is needed only if there is a requirement to do Velocity 4 to IntelliSlot based cards and BACnet or Modbus RS-485 simultaneously. See **Figure 7.3** on the facing page for the expansion board.

Figure 7.3 Expansion Board

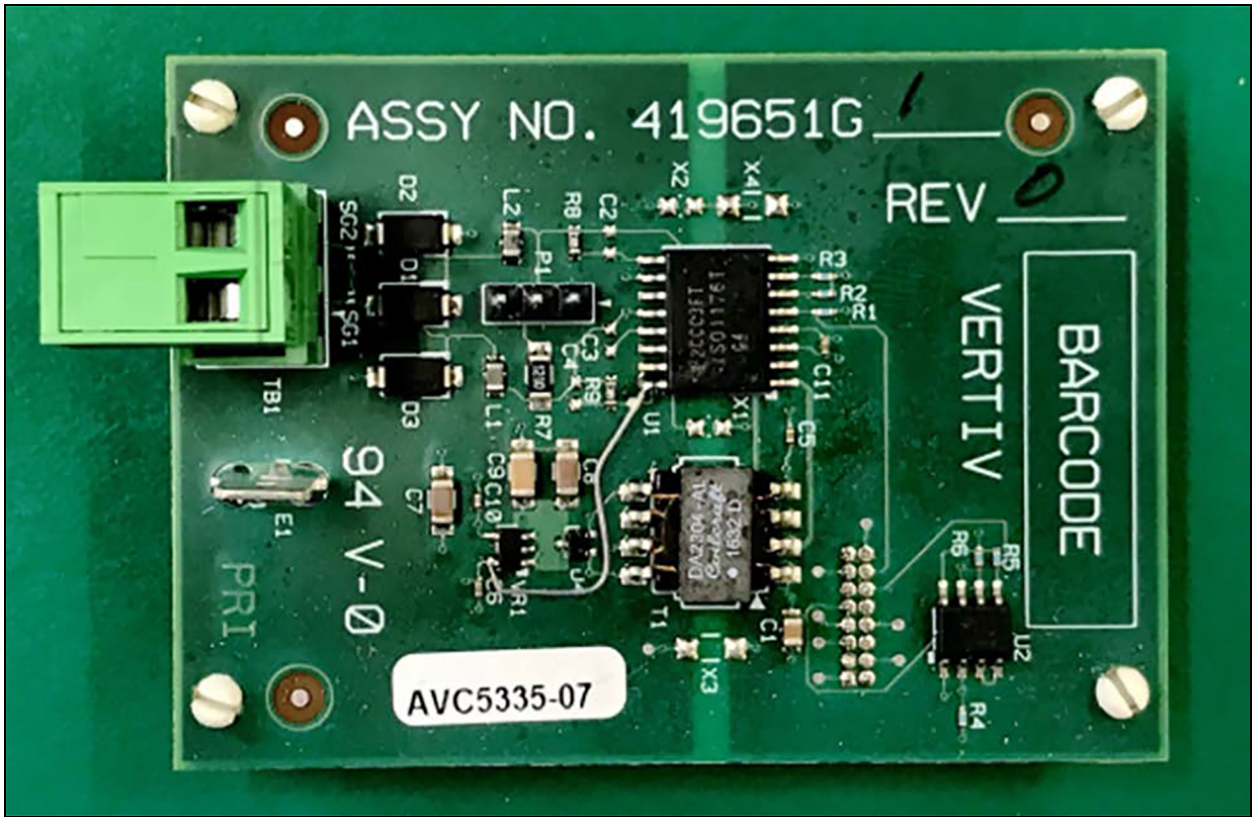

Table 7.1 below, lists problems you may encounter with the Unity software and possible solutions.

Table 7.1 Embedded Unity Troubleshooting

Problem	Possible cause	Suggested Remedy
Settings are not available in local-unit Liebert® iCOM™ display, show as "IS-Unity Service is Unavailable"	Embedded Unity is not enabled.	Make sure the correct monitoring protocol is selected in BMS Set-up. See Configuring BMS Communication with Embedded Unity on page 73.
	Unity software needs more time to boot-up since most-recent Liebert® iCOM™-controller or Unity reboot.	Wait no more than 10 minutes to give enough time to boot-up.
	The Liebert® iCOM™ user and password for Unity are incorrect.	Enter a valid username and password for the Liebert® iCOM™-to-Unity connection. See Embedded Unity User and Password on the next page.
	Embedded Unity has crashed.	Restart, and wait at least 5 minutes to fully boot-up. See Unity Restart and Restore Defaults on page 81.
	Unity configuration had become corrupt.	Restore to defaults, see Unity Restart and Restore Defaults on page 81. NOTE: All customized Unity configuration settings will be lost. Use this as a last resort.
Ethernet to BMS network not communicating/connecting	BMS Ethernet drop is connected to the wrong RJ-45 connector on the Liebert® iCOM™ control	Make sure that the cable is connected to P74 on the Liebert® iCOM™ control board, and corrected if needed.

Table 7.1 Embedded Unity Troubleshooting (continued)

Problem	Possible cause	Suggested Remedy
485 twisted pair to BMS network not communicating/connecting	board.	
	Ethernet cable is badly- or incorrectly-made.	Use a cable tester that gives a quality rating and length (sends a true data packet) to test the cable and correct as needed.
	Incorrect network settings.	Correct the IPv4 network settings, see IPv4 and IPv6 Configuration on page 85 . NOTE: If you adjust the settings, you must restart the Unity software for the changes to take effect.
485 twisted pair to BMS network not communicating/connecting	Incorrect polarity.	Correct the polarity. See Connecting to the BMS on page 76 .
	Incorrect protocol settings.	Verify and correct the settings. Refer to the configuration settings that apply to your system: <ul style="list-style-type: none"> • BACnet Protocol Set Up on page 97 . • Modbus Protocol Set Up on page 100 . • SNMP Protocol Setup on page 102 .
	Protocol settings have not been saved.	Save the settings, and restart Unity so the configuration is authorized/applied. See Unity Restart and Restore Defaults on the facing page .

7.2.2 Embedded Unity User and Password

Changes to the Unity configuration are authenticated with a user/password that is stored in Vertiv™ Liebert® iCOM™. The stored user name and password must match that of a user account in embedded Unity, see [Local Users Configuration](#) on page 83 , for a description of the Unity accounts. By default, the user/password is Liebert/Liebert (case sensitive). If you are not using the default combination in Unity , then you must update Liebert® iCOM™ with the matching username and password.



1. Touch  , then  > *BMS & Teamwork* > *IS-Unity Settings*.
2. Adjust the Username and Password, and touch *Save*.

7.2.3 Unity Restart and Restore Defaults



Some types of configuration changes require a restart of the embedded Unity software to take effect. Using the Restart IS-Unity option, does not affect the Liebert® iCOM™ controller.

You also have the option of restoring the configuration to factory defaults if communication problems occur and cannot be remedied with troubleshooting

To Restart Embedded Unity

1. Touch , then  > *BMS & Teamwork > IS-Unity Settings*.
2. Touch *Restart IS-Unity*, then *Save*.



To Reset the Configuration to Factory Defaults

1. Touch , then  > *BMS & Teamwork > IS-Unity Settings*.
2. Touch *Default IS-Unity Setup*, then *Save*.



7.2.4 System Configuration

System displays general information about the monitored and managed device. You can select the temperature units displayed. Celsius is the default.

To Update System Settings

1. Touch , then  > *BMS & Teamwork > IS-Unity Setup > Configuration > System*.
2. Adjust the information, and touch *Save*. The settings are configured.

Time Service Settings

1. Touch , then  > *BMS & Teamwork > IS-Unity Setup > Configuration > System > Time Service*.
2. Adjust the settings, and touch *Save*.

Time Service Setting Options

External Time Source

The external source to use for time synchronization. The default is NTP Server.

Primary NTP Time Server

URL, Hostname, or IP address of the primary NTP time source. This option has a 64 character maximum.

Backup NTP Time Server

URL, Hostname, or IP address of the backup NTP time source. 64-character maximum.

NTP Time Sync Rate

The rate at which time will be synchronized with the Network Time Protocol server, if NTP is the external time source.

Time Zone

Time zone where the device is located.

Enable Auto-Sync to Managed Device

Enable automatic writing time to the managed device.

Managed Device Auto-Sync Rate

Rate at which time will be written to the managed device, if an external time source has been selected.

7.2.5 Local Users Configuration

Local Users offers up to 10 users and three access levels described in **Table 7.2** below .

The default password for all users is *Liebert* (case sensitive).



Table 7.2 User Access Levels

Level Name	Access/ Permission Type	Description
No Access	None	The No Access level is enforced when Password Protected Site is enabled.
General User	Read-only	Able to view all tabs, folders and sub-folders of the user interface. A General User will only need to enter the assigned password if Password Protected Site is enabled, see Web Server Configuration on page 87 . By default, Local User [2] is <i>User</i> with the default password <i>Liebert</i> (both are case-sensitive). The Authorization (access type) for Local User [2] is "General User."
Administrator	Read/Write	Able to edit settings using the assigned password, which is always required to edit settings/configuration. By default, Local User [1] is <i>Liebert</i> with the default password <i>Liebert</i> (both are case sensitive). The Authorization (access type) for Local User [1] is Administrator. Be sure that you always have one administrator user, so you can access and modify configuration and other settings.



IMPORTANT! Record user names and passwords and save them in a secure place where they can be found if forgotten. A lost password cannot be retrieved from the Embedded Unity. If the administrator password is lost, the Embedded Unity must be reset to factory defaults and reconfigured.

To Change User Names and Passwords

NOTE: There is a 30 character maximum. All printable characters are valid except: \ : ' < > ~ ? " #

1. Touch , then  > *BMS & Teamwork* > *IS-Unity Setup* > *Configuration* > *Users* > *User [n]*.
2. Enter a new user name and password.
3. Re-enter the password to confirm it.
4. In *Authorization for User*, select the type of access, see **Table 7.2** above .
5. Touch *Save*.

7.2.6 Network Configuration

1. Touch , then  > *BMS & Teamwork > IS-Unity Setup > Configuration > Network*.
2. Adjust the settings, and touch Save.

Network Setting Options

Speed Duplex

Selects the speed and duplex configuration of the BMS Ethernet port. It is set to Auto by default. If it requires changing, contact the system administrator for the proper settings.

Hostname

Identifies the network node. Default is *UNITY-serial_number_of_card*.

Domain Name Suffix List

Listing of domain name suffixes for resolution of host names. If it requires changing, contact the system administrator for the proper setting.

Telnet Server



Enables/disables telnet access to the monitoring to prevent unauthorized changes. The default setting disables telnet access.

SSHv2 Server

Enables/disables SSHv2 (Secure SHell) access to the monitoring to prevent unauthorized changes. The default setting disables SSHv2 access.

IPv4 and IPv6 Configuration

The IPv4 and IPv6 settings determine which Internet Protocol will be used for communication over the network connected to the Ethernet port. IPv4 and IPv6 networks will run in parallel (dual stack network), but the protocols are different. See your network administrator to determine which protocol should be enabled and to determine the correct settings.

1. Touch , then  > *BMS & Teamwork* > *IS-Unity Setup* > *Configuration* > *Network* > *IPv4 or IPv6*.
2. Adjust the settings, and touch *Save*.

IPv4 Settings

IPv4 Protocol

Enables IPv4 .

IP Address Method

Mode the Embedded Unit boots into to be a network ready device (Static, DHCP, BootP). The default is DHCP.

Static IP Address

Network address for the interface.

Subnet Mask

Network mask for the interface which divides a network into manageable segments.

Default Gateway

IP address of the gateway for network traffic destined for other networks or subnets

DNS Server Address Source

Source of DNS server identification. (None, Automatic, or Configured.)

Primary DNS Server

Network address of the primary DNS server.

Secondary DNS Server

Network address of the secondary DNS server.

IPv6 Settings

IPv6 Protocol

Enables IPv6 in the Embedded Unity.

IP Address Method

Mode the Embedded Unity boots into to be a network ready device. (Static or Auto.) The default is Auto.

Static IP Address

Network address for the interface.

Prefix Length

Prefix length for the address that divides a network into manageable segments.

Default Gateway

IP address of the gateway for network traffic destined for other networks or subnets. The default is 64.

DNS Server Address Source

Source of DNS server identification (None, Automatic, or Configured). The default is Automatic.

Primary DNS Server

Primary DNS Server.

Secondary DNS Server

Secondary DNS Server.

Domain Name Server (DNS) Test

The Domain Name Server Test checks key points of a Domain Name Server (DNS) setup for a given domain.

1. Touch , then  > *BMS & Teamwork > IS-Unity Setup > Configuration > Network > DNS Test.*
2. Adjust the settings, and touch *Save.*

Domain Name Server (DNS) Test Settings

Last Query Response

Response from a domain name server (DNS) to the last query.

Example: *gxtwebdemo.liebert.com* resolved to *126.4.203.251*

Type of Query



Type of DNS query. (Hostname, IP Address.)

Query Value

Value for the domain name server (DNS) to resolve. For example, *gxtwebdemo.liebert.com.*

7.2.7 Web Server Configuration

Web server settings configure some security settings such as HTTP or HTTPS and password enabling.

1. Touch , then  > *BMS & Teamwork* > *IS-Unity Setup* > *Configuration* > *Web Server*.
2. Adjust the settings, and touch *Save*.

Web Server Settings

Web Server Protocol

Select the operation mode of the web server (HTTP or HTTPS).

HTTP Port

Standard web port not encrypted. Required if HTTP is enabled as web server protocol. The default is 80. Must be set to 80 for correct Vertiv™ Liebert® iCOM™ connection.

HTTPS Port

Standard secure web port. All communication is encrypted. Required if HTTPS is enabled as web server protocol. The default is 443. Must be set to 443 for correct Liebert® iCOM™ connection.

Password Protected Site

When enabled, a log in session is required before any device information is displayed to the user. User level credentials will allow only viewing of device information. Administrator level credentials are required to make any changes.

Remote Write Access

When enabled, all web browsers have write access to data on all Unity web pages when the user is logged in with Administrator credentials. When disabled, write access is restricted to web browsers connected on an Autoconfiguration IPv4 address. An Autoconfiguration IPv4 address is of the form 169.254.x.x, and is negotiated automatically when a direct connection is made between the Ethernet port of your PC and the dedicated monitoring/BMS port of the Unity card. Regardless of this setting, all web browsers always have read access to the web pages (subject to the setting of the Password Protected Site parameter), and the diagnostic information file can be generated when the user is logged in with Administrator credentials (see [Unity Support Information](#) on page 107).

NOTE: When Remote Write Access is disabled, an indicator is displayed in the upper right corner of the web page as a reminder, shown in the following figure.

NOTE: Only disable remote write access if you are absolutely sure that you do not need to administer the managed device or the Embedded Unity through a remote web browser session.

Session Idle Timeout

The interval the software will wait before logging off a user unless there is user activity. (The default is five minutes.)

Certificate Configuration

When the web server protocol is configured to use HTTPS communications, all web server communication with all browsers is encrypted and validated based upon the security algorithms and validity checks specified in the SSL certificate that is currently installed in the Embedded Unity. By default, the Unity generates its own unique, self-signed SSL certificate when it is first powered up. However, many installations want to install and use SSL certificate files that were generated by their own Certificate Authority (CA).

Selections in Certificate provide commands to Upload SSL Certificate PEM Files or Generate Self-Signed SSL Certificate.

Certificate Commands

Generate Self-Signed SSL Certificate

Generates and installs a new self-signed certificate based on the mode selected for Generate Self-Signed SSL Certificate Mode. See [Generating a Self Signed SSL Certificate](#) on the facing page .

Generate Self-Signed SSL Certificate Mode

This is the method used to generate a self-signed SSL certificate. Options are:

- Use Default Values: The values used in place of the user configurable fields are the same as those used when the original SSL certificate was generated by the Unity on first power up. The default values are not displayed.
- Use Configured Settings: The user entered values in the configurable fields are used to generate the certificate.

NOTE: When using configured settings, all of the configurable fields, described below, must have an entry to successfully generate a certificate.

Common Name

Fully qualified domain name that browser clients will use to reach the Unity web server when it is running with the certificate generated with the name entered here.

Organization

Organization or company identified as the owner of the generated certificate.

Organizational Unit

Organizational unit or company division of the organization identified as the owner of the generated certificate.

City or Locality

City or locality of the organization identified as the owner of the generated certificate.

State or Province

State or province of the organization identified as the owner of the generated certificate.



Country Code

Country code (two-letter abbreviation) of the organization identified as the owner of the generated certificate.



Email Address

E-mail address of the contact within the organization identified as owner of the generated certificate.

Generating a Self Signed SSL Certificate

1. Touch , then  > *BMS & Teamwork* > *IS-Unity Setup* > *Configuration* > *Web Server* > *Certificate*.
2. In Generate Self-Signed SSL Certificate Mode, select the mode to use.
 - If you select *User Configured Settings*, make entries in all of the configurable-value fields (required).
3. Touch *Save*.
4. Follow the instructions in the dialog to generate and install the certificate.

7.2.8 Remote Services Configuration

1. Touch , then  > *BMS & Teamwork* > *IS-Unity Setup* > *Configuration* > *Remote Services*.
2. Adjust the settings, and touch *Save*.

The folder contains subfolders for connectivity and diagnostics:

- [Remote Services Connectivity](#) on the next page
- [Remote Services Diagnostics](#)

Remote Service Options and Settings**Serial Number from Device**

Serial number obtained from the managed device. Identifies the device to the system unless *Device Serial Number Override* is enabled.

Reset Remote Services Config

Resets configuration of the remote service back to factory defaults.

NOTE: Does not reset the communication configuration.

Remote Service

Enables/disables remote service connection.

Device Data Sampling

Enables/disables, data sampling of the device.

Device Serial Number

Serial number used when *Device Serial Number Override* is enabled.

Device Serial Number Override

Enables/disables use of the serial number obtained from the managed device.

Site Equipment Tag Number

Number from the site equipment tag.

Site Identifier

Site identification number.

Device Instance ID

Manufacturer's device identification number.

Service Center Country

Country in which the device is serviced.

7.2.9 Remote Services Connectivity

Remote Service Connectivity Options and Settings

Connectivity Test Result

Result of most recent connectivity test.

Test Connectivity

Initiates connectivity test.

Evaluate Remote Services Configuration

Attempt to connect to the remote service to verify the configuration.

Remote Service Platform URL

URL address of the remote-service platform. Do not enter the HTTP:// or HTTPS:// prefix.

Connection Retry Time

Length of time to attempt reconnection in the event of a communication failure. Range: 30 to 600 seconds.

Proxy Enable

Enables use of remote service platform URL to connect with a proxy server.

Proxy Authentication

Enables authentication of the proxy server.

Proxy Address

IP or URL address of the proxy server.

Proxy IP Port Number

Port number of the proxy server. Range: 1 to 65535.

Proxy User Name

User name of the proxy server.

Proxy User Password

Password of the proxy server.



Remote Service Cloud URL

URL address of the remote-service cloud. Do not enter the HTTP:// or HTTPS:// prefix.

7.2.10 Velocity Protocol Configuration

Velocity Protocol contains four subfolders: Managed Device, MSTP, Ethernet, and Internal.

NOTE: With the exception of changing the node ID when multiple cards are used or when disabling Velocity Protocol IP access, the settings in the Velocity Protocol sub-folders should not be modified unless directed by a Vertiv™ representative.

1. Touch , then  > *BMS & Teamwork* > *IS-Unity Setup* > *Configuration* > *Velocity Protocol*.
2. Adjust the settings, and touch *Save*.

Velocity Protocol Options**Velocity Protocol IP Access**

When disabled, prevents access from a remote, IP-based system using the Velocity Protocol

Velocity Protocol Managed Device options**Connection State**

Status of connection to managed device.

FDM Version

Version of the managed device.

Product Sequence ID

Product-sequence identifier of the managed device.

LAN Type

Type of interface connection to the managed device. Must be set to MSTP Internal for correct communication with Vertiv™ Liebert® iCOM™.

Node ID (MSTP Only)

Identifier of the managed device on an MSTP LAN.

IP Address (IP Only)

Address of the managed device on an IP LAN.

Velocity Protocol MSTP Options

Interface

Type of MSTP interface.

Data Rate

Communication rate in bps.

Max Master Address

Maximum node ID in use on the MSTP interface.

Network Number

Network number of the MSTP interface. 1 to 65534.

Node ID

Node ID of the agent card on the MSTP LAN. 0 to 127.

Velocity Protocol Ethernet Options

Velocity Protocol IP Port Number

Port number of the IP interface. 1 to 65535.

Network Number

Network number of the Ethernet interface. 1 to 65534.

Velocity Protocol Internal Options

Network Number

Internal network number used on the agent card. Not available to other interfaces.

7.2.11 Messaging Configuration

Messaging enables and disables email and text messaging about events. It includes a test to determine if email and text messages can be successfully sent. Settings specify message recipients, the format of the messages, and other details.

Messaging Options



E-mail

May be enabled to send email messages about events

SMS

May be enabled to send text messages about events

7.2.12 E-Mail Messaging Configuration

1. Touch , then  > *BMS & Teamwork > IS-Unity Setup > Configuration > Messaging > Email.*
2. Adjust the settings, and touch Save.

E-Mail Settings

E-Mail From Address

Sender's e-mail address. In most cases this will be the e-mail address of the person to whom replies should be sent. For example: *Support@company.com*.

E-mail To Address

E-mail address of the recipient. Multiple e-mail addresses should be separated by a semicolon.

E-Mail Subject Type

Subject of the e-mail. This value will default to the event description. The subject line can be customized.

Custom Subject Text

The subject of the e-mail can be changed.

SMTP Server Address

Fully qualified domain name or IP address of the server used for relaying e-mail messages. If using a server name, a DNS server may need to be configured under Network Settings.

SMTP Server Port

SMTP server port.

SMTP Connection

SMTP server connection type. Determines the capabilities of the SMTP server. Options are:

- Clear: Do not use encryption.
- SSL/TLS: Encryption using SSL/TLS connection.
- STARTTLS: SSL/TLS encryption initiated using STARTTLS.

SMTP Authentication

Enable/disable email SMTP authentication. An e-mail account must be provided for the SMTP service provider to authenticate.

NOTE: Some email servers may require account configuration changes to allow communication with Embedded Unity. For example, Gmail only recognizes Google applications as being secure. However, they provide an account setting that allows authentication with what they consider less secure apps. Please see your network administrator or service provider for configuration details.

SMTP Username

Username of the e-mail account to use when e-mail SMTP authentication is enabled.

SMTP Password

Password for the e-mail account to use when e-mail SMTP authentication is enabled.

Include IP Address in Message

If checked, the IP Address of the agent card will be included in outgoing messages.

Include Event Description in Message

If True, SNMP event description will be included in outgoing messages.

Include Name in Message

If checked, the agent card Name will be included in outgoing messages.

Include Contact in Message

If checked, the agent card Contact will be included in outgoing messages.

Include Location in Message

If checked, the agent card Location will be included in outgoing messages.

Include Description in Message

If checked, the agent card Description will be included in outgoing messages.

Include Web Link in Message

If checked, a web link to the agent card and web server listening port number will be included in outgoing messages.

Enable Event Consolidation

If checked, multiple events will be sent per outgoing message.



Consolidation Time Limit

If Event Consolidation is enabled, a message will be sent when Consolidation Time Limit seconds has passed since the first buffered event was received.

Consolidation Event Limit

If Event Consolidation is enabled, a message will be sent when the number of buffered events reaches the Consolidation Event Limit.

7.2.13 SMS Messaging Configuration

1. Touch , then  > *BMS & Teamwork* > *IS-Unity Setup* > *Configuration* > *Messaging* > *SMS*.
2. Adjust the settings, and touch *Save*.

SMS Settings**SMS From Address**

Sender's SMS address. In most cases this will be the SMS address of the person to whom replies should be sent. For example: Support@company.com.

SMS To Address

SMS address of the recipient. Multiple SMS addresses should be separated by a semicolon.

SMS Subject Type

Subject of the message, either Default or Custom.

Custom Subject Text

The subject of the message; can be customized by the customer

SMTP Server Address

Fully qualified domain name or IP address of the server used for relaying SMS messages.

NOTE: If using a server name, a DNS server may need to be configured under Network Settings.

SMTP Server Port

SMTP server port.

SMTP Connection

SMTP server connection type. Determines the capabilities of the SMTP server. Options are:

- Clear: Do not use encryption.
- SSL/TLS: Encryption using SSL/TLS connection.
- STARTTLS: SSL/TLS encryption initiated using STARTTLS.

SMTP Authentication

Enable or disable SMS SMTP authentication. An SMS account must be provided for the SMTP service provider to authenticate.

NOTE: Some messaging servers may require account-configuration changes to allow communication with Embedded Unity. For example, Gmail only recognizes Google applications as being secure. However, they provide an account setting that allows authentication with what they consider less secure apps. Please see your network administrator or service provider for configuration details.

SMTP Username

Username of the SMS account to use when SMS SMTP authentication is enabled.

SMTP Password

Password for the SMS account to use when SMS SMTP authentication is enabled.

Include IP Address in Message

If True, the IP Address of the agent card will be included in outgoing messages.

Include Event Description in Message

If checked, SNMP event description will be included in outgoing messages.

Include Name in Message

If checked, the agent card Name will be included in outgoing messages.

Include Contact in Message

If checked, the agent card Contact will be included in outgoing messages.

Include Location in Message

If checked, the agent card Location will be included in outgoing messages.

Include Description in Message

If checked, the agent card Description will be included in outgoing messages.

Include Web Link in Message

If checked, a web link to the agent card and web server listening port number will be included in outgoing messages.

Enable Event Consolidation

If checked, multiple events will be sent per outgoing message.

Consolidation Time Limit



If Event Consolidation is enabled, a message will be sent when Consolidation Time Limit seconds has passed since the first buffered event was received.

Consolidation Event Limit



If Event Consolidation is enabled, a message will be sent when the number of buffered events reaches the Consolidation Event Limit.

Messaging Test

Tests the set up for email and SMS messages. If the test fails, incorrect settings should be changed to ensure that proper notifications are sent if an event should occur.

1. Touch , then  > *BMS & Teamwork* > *IS-Unity Setup* > *Configuration* > *Messaging* > *Messaging Test*.
2. Enter the settings, select the type of test in *Send Test Message*, and touch *Save*.

7.2.14 BACnet Protocol Set Up

1. Touch , then  > *BMS & Teamwork* > *IS-Unity Setup* > *Protocols* > *BACnet*.
2. Adjust the settings, and touch *Save*.
3. Configure the BACnet interface chosen. See [Configuring BACnet IP Protocol](#) on the next page or [Configuring BACnet MSTP Protocol](#) on page 99.

BACnet Settings

Managed Device Write Access

Enable or disable the BACnet server to write to the managed device.

BACnet Interface

BACnet server interface: BACnet IP or BACnet MSTP.

Device Object Instance Number

The instance number (0-4194302) of the BACnet server's device object.

Device Object Name

The name of the BACnet server's device object.





APDU Timeout

The time out in milliseconds between APDU retries (1-65535).

APDU Retries

The number of times to retransmit an APDU after the initial attempt (0-8).

Configuring BACnet IP Protocol

1. Touch , then  > *BMS & Teamwork* > *IS-Unity Setup* > *Protocols* > *BACnet* > *BACnet IP*.
2. Set the BACnet MSTP Node ID.
 - The Node ID defaults to 1, but must have a value from 0 to 127 that is unique among devices connected through the RS-485 interface.
3. Set the BACnet MSTP Data Rate.
4. Set the BACnet MSTP Max Master Address.
5. Set the BACnet MSTP Max Info Frames.
6. Touch *Save*.
7. Restart Unity:
 - a. Touch , then  > *BMS & Teamwork* > *IS-Unity Settings*.
 - b. Touch *Restart IS-Unity*., then touch *Yes*.

BACnet IP Settings

BACnet IP Port Number

The port for the BACnet server's UDP/IP connection.

Register as Foreign Device

Enable/disable registration as a foreign device.





IP Address of BBMD

IP address of the BACnet Broadcast Management Device (BBMD) to be accessed for foreign device registration

Foreign Device Time to Live

Time to remain in the BBMD foreign device table after registration.

Configuring BACnet MSTP Protocol

1. Touch , then  > *BMS & Teamwork > IS-Unity Setup > Protocols > BACnet > BACnet IP.*
2. Set the BACnet MSTP Node ID.
 - The Node ID defaults to 1, but must have a value from 0 to 127 that is unique among devices connected through the RS-485 interface.
3. Set the BACnet MSTP Data Rate.
4. Set the BACnet MSTP Max Master Address.
5. Set the BACnet MSTP Max Info Frames.
6. Touch *Save.*
7. Restart Unity:
 - a. Touch , then  > *BMS & Teamwork > IS-Unity Settings.*
 - b. Touch *Restart IS-Unity.*, then touch *Yes.*

BACnet MSTP Settings

Node ID

The BACnet server's MS/TP node ID (MAC).

Data Rate

The BACnet MSTP communication rate (bits per second).



Max Master Address

The maximum node ID (MAC) in use on the MS/TP network.

Max Info Frames

Maximum number of information frames this node may send before it must pass the token.

7.2.15 Modbus Protocol Set Up

1. Touch , then  > *BMS & Teamwork* > *IS-Unity Setup* > *Protocols* > *BACnet*.
2. Adjust the settings, and touch Save.
3. Configure the BACnet interface chosen.
See [Configuring Modbus TCP Protocol](#) below , or [Configuring Modbus RTU Protocol](#) on the facing page .

Modbus Settings

Managed Device Write Access

Enable or disable the Modbus server to write to the managed device.

Modbus Interface





Select the Modbus interface, either Modbus TCP or Modbus RTU.

Configuring Modbus TCP Protocol

The Modbus TCP permits connection to Embedded Unity by:

- Any client (open) permits communication by any IP address.
- Clients on the same subnet as Embedded Unity.
- Clients with specific IP addresses (Trusted IP Lists); only five addresses are permitted.

To Configure Modbus TCP

1. Touch , then  > *BMS & Teamwork* > *IS-Unity Setup* > *Protocols* > *Modbus TCP*.
2. Adjust the settings, and touch Save.
3. Restart Unity:
 - a. Touch , then  > *BMS & Teamwork* > *IS-Unity Settings*.
 - b. Touch *Restart IS-Unity.*, then touch Yes.

Modbus TCP Settings

Limit Network Access Type

IP Access List

- Open
- Same Subnet
- Trusted IP List



Port

The TCP port used by the Modbus Server to listen for and respond to Modbus protocol requests based on Limit Network Access Type setting.



Maximum Client Connection Count

The maximum number of simultaneous connections allowed.

Configuring Modbus RTU Protocol

1. Touch , then  > *BMS & Teamwork > IS-Unity Setup > Protocols > Modbus RTU*.
2. Enter the Node ID and the Baud Rate.
 - The Node ID defaults to 1, but must have a value from 1 to 247 that is unique among devices connected through the RS-485 interface.
 - The default baud rate is 9600. 19200 and 38400 are also available.

NOTE: Contact your system administrator if you are uncertain about the settings.

3. Touch *Save*.
4. Restart Unity:
 - a. Touch , then  > *BMS & Teamwork > IS-Unity Settings*.
 - b. Touch *Restart IS-Unity*., then touch *Yes*.

Modbus RTU Settings**Node ID**

Modbus Server ID for the interface; obtain from network administrator.

Baud Rate

Communication rate.

- 9600
- 19200
- 38400





Parity Check

The communication parity check.

- None
- Even
- Odd

7.2.16 SNMP Protocol Setup

SNMPv1/v2c and SNMPv3 are enabled by default. The protocols may be configured or their default values may be accepted. Authentication Traps are not enabled by default. The default Heartbeat Trap interval is 24 hours. This can be disabled or the interval may be changed.

1. Touch , then  > *BMS & Teamwork > IS-Unity Setup > Protocols > SNMP.*
2. To enable Authentication Traps, touch to select *Enabled*.
3. To change the Heartbeat Trap Interval, choose a time from the drop-down list or choose *Disabled* to prevent any heartbeat traps from being sent.
 - The interval times offered are 5 minutes, 30 minutes, or 1, 4, 8, 12, and 24 hours.
4. For each trap, choose whether or not to disable or set the interval to one of the periods on the menu.
5. Touch *Save*.
6. Restart Unity:
 - a. Touch , then  > *BMS & Teamwork > IS-Unity Settings.*
 - b. Touch *Restart IS-Unity.*, then touch *Yes*.

SNMP Settings

SNMPv3 Engine ID

Read-only. The generated SNMPv3 engine ID.

NOTE: A newly generated ID appears only after rebooting Unity.

SNMP v1/v2c Enable

Enable/disable SNMP v1/v2c.

SNMP v3 Enable

Enable /disable SNMPv3.

Authentication Traps

When enabled, an Authentication Trap is sent if an SNMP host tries to access Unity via SNMP, but either the host address is not in the SNMP Access Settings or it is using the wrong Community String.

Heartbeat Trap Interval

Enable/disable and set interval 5 minutes, 30 minutes, 1 hour, 4 hours, 8 hours, 12 hours and 24 hours.

RFC-1628 MIB

Enable/disable support for retrieval of data from the RFC-1628 MIB objects.

RFC-1628 MIB Traps

Enable/disable support for sending RFC-1628 traps.

Vertiv™ Liebert® Global Products (LGP) MIB

Enable/disable support for getting and setting data using the Liebert® Global Products MIB.

LGP MIB Traps

Enable/disable support for Liebert® Global Products MIB traps.

NOTE: LGP traps will not be sent unless LGP MIB is enabled.

LGP MIB System Notify Trap

Enable/disable support for the LGP System Notification trap. This is a single trap sent each time an alarm or warning is added or removed from the conditions table. It provides a text description of the event in a varbind of the trap message.

NOTE: LGP System Notify Traps will not be generated unless the LGP MIB is enabled.

SNMP v3 Engine ID Format Type

Selects method to build the engine ID. Valid values are:

- MAC Address (default): Engine ID built from the Unity MAC address.
- Text: Engine ID built from text entered in SNMPv3 Engine ID Text. See [Select SNMPv3 Engine ID Format](#) below .



SNMP v3 Engine ID Text

Text on which the engine ID is built when SNMPv3 Engine ID Format Type is *Text*.

NOTE: If this field is left blank, the engine ID is built from the Unity MAC address.

Select SNMPv3 Engine ID Format

By default, the Engine ID is automatically generated using the MAC address. Optionally, you can select a text-based ID instead.

1. Touch , then  > *BMS & Teamwork > IS-Unity Setup > Protocols > SNMP.*

2. Select the format:
Refer to [SNMP Protocol Setup](#) on page 102, for descriptions of the settings and options.
 - In SNMPv3 Engine ID Format Type, select *MAC Address* or *Text*.
 - If you selected *Text*, type the text on which the generated engine ID will be based.
 - Click *Save* to confirm the changes or *Cancel* to discard them. The new engine ID is not displayed until after rebooting Unity in Step 3. The text generated engine ID is a hexadecimal representation of ASCII characters similar to that shown in **Figure 7.4** below.

NOTE: If the format type or text for the Engine ID are incomplete or invalid, the Engine ID is generated based on the MAC Address.



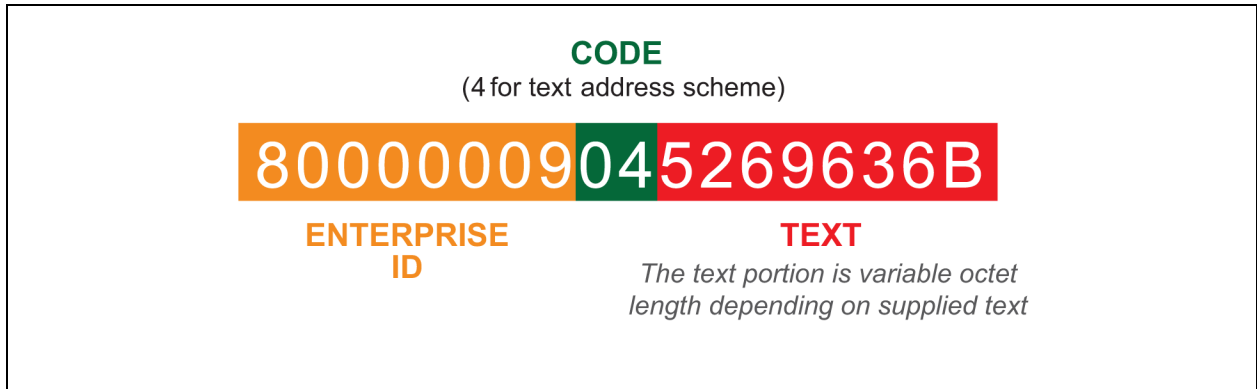

3. Restart Unity:
 - a. Touch , then  > *BMS & Teamwork* > *IS-Unity Settings*.
 - b. Touch *Restart IS-Unity*., then touch *Yes*.

Figure 7.4 SNMP Engine ID Generated Using Text Format Scheme



Configuring SNMP v3 Users

IS-Unity supports up to 20 SNMP v3 users. The top level is a list of all 20.

1. Touch , then  > *BMS & Teamwork* > *IS-Unity Setup* > *Protocols* > *SNMP* > *SNMPv3 Users*, then one of the listed users.
2. Enter the information and set the permissions appropriate to the user, and touch *Save*.
3. Repeat steps 1 and 2 for additional users.
4. Restart Unity:
 - a. Touch , then  > *BMS & Teamwork* > *IS-Unity Settings*.
 - b. Touch *Restart IS-Unity*., then touch *Yes*.

SNMP v3 User Settings

SNMP v3 User Enable

Select to enable read, write or sending notifications with the user's credentials.

SNMP v3 Username

The user name that the authentication and privacy settings apply to. This string can be composed of printable characters except colon, tab, double quote, and question mark.

SNMP v3 Access Type

Read Only, Read/Write or Traps only.

SNMP v3 Authentication

Cryptographic algorithm used for authentication: None, MD5 ,or SHA-1.

SNMP v3 Authentication Secret

Pass phrase or password used for SNMP v3 Get request. This string can be composed of printable characters with the exception of colon, tab, double quote, and question mark.

NOTE: Note: The entry must be eight or more characters, up to 64 characters.

SNMP v3 Privacy

Cryptographic algorithm used for encryption. Options are:

- None
- DES
- AES

SNMP v3 Privacy Secret

Pass phrase or password used for SNMPv3 Get request. This string can be composed of printable characters with the exception of colon, tab, double quote, and question mark. Note: The entry must be 8 or more characters but not more than 64.

SNMP v3 Trap Target Addresses





Network hosts that will receive SNMPv3 traps, identified with either a network name or IP address. Multiple addresses must be separated by commas.

SNMP v3 Trap Port

Port used by the target host for receiving SNMP v3 traps; default is 162.

Configuring SNMP v1 Traps

You may configure up to 20 network hosts that receive SNMP v1 traps. The top level is a list of all 20.

1. Touch , then  > *BMS & Teamwork* > *IS-Unity Setup* > *Protocols* > *SNMP* > *SNMPv1 Traps*, then one of the listed traps.
2. Enter the information and set the permissions appropriate to the host/trap, and touch *Save*.
3. Repeat steps 1 and 2 for additional traps.
4. Restart Unity:
 - a. Touch , then  > *BMS & Teamwork* > *IS-Unity Settings*.
 - b. Touch *Restart IS-Unity*., then touch *Yes*.

SNMPv1 Trap Settings

SNMP Trap Target Addresses

Configure network hosts that will receive alert notifications (i.e., SNMP Traps). The host can be identified as either an IP address or the host's network name.

SNMP Trap Port





Port used by the target host for receiving notifications; default is 162.

SNMP Trap Community String

String identifying a secret known only by those hosts that want to be notified of device status changes.

Configuring SNMPv1/v2c Access

Unity supports up to 20 network hosts that access data using SNMPv1/v2c. The top level is a list of all 20.

1. Touch , then  > *BMS & Teamwork* > *IS-Unity Setup* > *Protocols* > *SNMP* > *SNMPv1v2c Access*, then one of the listed access options.
2. Enter the information and set the permissions appropriate to the network host, and touch *Save*.
3. Repeat steps 1 and 2 for additional users.
4. Restart Unity:
 - a. Touch , then  > *BMS & Teamwork* > *IS-Unity Settings*.
 - b. Touch *Restart IS-Unity*., then touch *Yes*.

SNMPv1/v2c Access Settings

SNMP Access IP Address

Configure network hosts interested in device information access. The host can be identified as either an IP address or the host's network name

SNMP Access Type

SNMPv1/v2C access type: Read Only or Read/Write

SNMP Access Community String

SNMP Community String



7.3 Unity Status Readings

The read only Status page displays the system status of IS-Unity and a list of events that affect its status.

To view the statuses, touch , then  > *BMS & Teamwork* > *IS-Unity Setup* > *Status*.

7.4 Unity Support Information

Support displays information about IS-Unity for troubleshooting.

1. Touch , then  > *BMS & Teamwork* > *IS-Unity Setup* > *Support*.
2. Adjust the settings, and touch *Save*.

7.4.1 Support Folder Settings

Agent Date and Time

Date and time setting for Unity.

Agent Model

The card's model (Unity Platform).

Agent App Firmware Version

The card's firmware version (2.0 or higher)

Agent App Firmware Label

The card's firmware label.

Agent Boot Firmware Version

The card's boot firmware version.

Agent Boot Firmware Label

The card's boot firmware label.

Agent Serial Number

The card's serial number.

Agent Manufacture Date

The card's manufacture date.

Agent Hardware Version

The card's hardware version

GDD Version

The card's GDD version, current when the card's firmware was installed; the GDD is a proprietary reference document for device data.

FDM Version

The card's FDM version; the FDM is a data model document that defines data supported by devices that use the Velocity Protocol.

Product Sequence ID



The card's product sequence identifier.

Device Assigned Label

Displays the label assigned to the device.

7.4.2 Configuring Active Networking Settings

Status of the currently active IP network settings for IS-Unity along with some previous values for troubleshooting IP communication issues.

1. Touch , then  > *BMS & Teamwork > IS-Unity Setup > Support > Active Networking*.
2. Adjust the settings, and touch Save.

Active Networking Settings

Ethernet MAC Address

Ethernet MAC Address for the Embedded-Unity Ethernet interface.

IPv4 Address

Presently used IPv4 network address.

IPv4 Default Gateway

Presently used IPv4 network address of the gateway for network traffic destined for other networks or subnets.

Primary DNS

Presently used IPv4 Primary DNS

Secondary DNS

Presently used IPv4 Secondary DNS

Last DHCP/BOOTP Address

Last known IPv4 address assigned by DHCP.

Last DHCP Lease

Lease time of last known DHCP address.

IPv6 Global Address

Shows if DHCPv6 or Static address is presently being used.

StateLess Address AutoConfiguration

IPv6 SLAAC is assigned automatically from Router Advertisement, if A flag is set, combining prefix with EUI-64 MAC.

Link Local

Presently used IPv6 Link Local Address.

IPv6 Default Gateway

Presently used IPv6 network address of the gateway for network traffic destined for other networks or subnets.

Primary DNS Server

IPv6 Primary DNS.

Secondary DNS Server

Presently used IPv6 Secondary DNS.

Last DHCPv6

Last known IPv6 address assigned by DHCPv6.



Last DHCPv6 Lease

Lease time of last known DHCPv6 address.

8 Configuring Auxiliary Devices

With Vertiv™ Liebert® iCOM™, you can manage and control many devices that work with your thermal management unit(s).

8.1 Configuring Analog Input Devices

1. Touch , then  > *Auxiliary Device Setup* > *Analog Input*.
The ANALOG INPUTS and ANALOG INPUT PROPERTIES panels open.
2. Before you touch a specific analog input, the properties panel lists the inputs along with their configuration status:

NOTE: Depending on the type of thermal management unit, included components, and control settings of your system, all of the options listed may not be available on your Liebert® iCOM™ display.

- *Factory Std* indicates that the input is configured for a factory-installed component such as a pressure transducer.
 - *Not Config* indicates that the input is configurable.
3. Locate the DIP switches on the control board and program the input type according to **Table 8.1** below .

Figure 8.1 below shows the switch and on/off setting.



Table 8.1 DIP Switch Settings for Analog Input Connection

Analog Input Number		Input #1		Input #2		Input #3		Input #4		Not used			
		Control Board Switch Number	1	2	3	4	5	6	7	8	9	10	
Analog Input Device Value	0 – 10 VDC	Off	Off	Off	Off	Off	Off	Off	Off	Off	—	—	
	0 – 5 VDC	On	Off	On	Off	On	Off	On	Off	On	Off	—	—
	4 – 20 mA	On	On	On	On	On	On	On	On	On	On	—	—

NOTE: Up is on and down is off on the DIP switch. Switches 9 and 10 are not used.

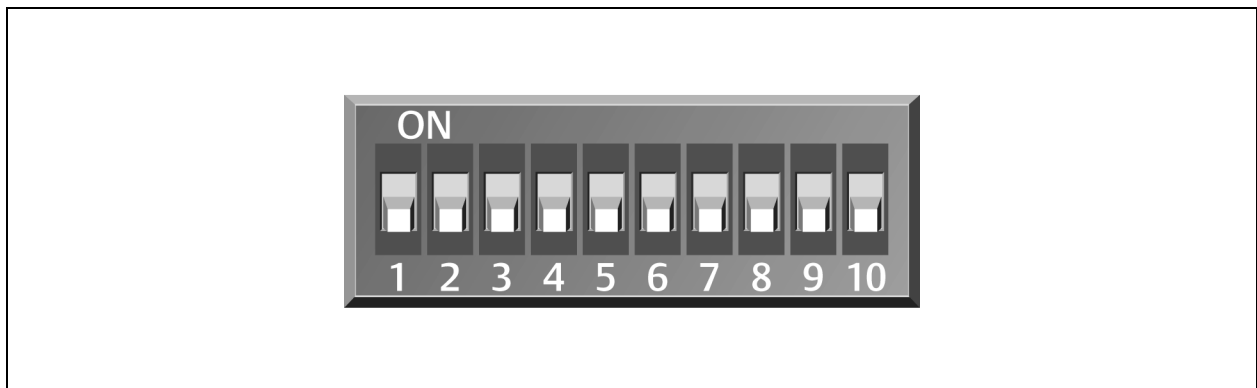
Figure 8.1 Analog Connection DIP Switches on the Control Board



4. On Vertiv™ Liebert® iCOM™, touch , then  > *Auxiliary Device Setup* > *Analog Input* > *Customer Analog Inputs*, then touch an Analog Input. The ANALOG INPUT PROPERTIES for that device displays.
5. Select the configuration and touch *Save*. The analog input is configured.



NOTE: The Airflow, Static Pressure and Fluid Flow analog input settings configure factory options and require special instruction. Contact Vertiv™ Technical Support at 1-800-543-2778.

8.2 Wired Remote Sensors

Wired, remote, rack sensors can function as control sensors and, subsequently, provide input individually, at the unit level, or at the system level for temperature control and teamwork functions.

Each wired remote rack sensor has two thermistors (probes). In Individual Sensor mode, the higher temperature reading or the average temperature reading of the two probes can be used. In Unit Sensors mode, some or all of the rack sensor's temperature readings are considered for higher (maximum) or average calculation. For example, setting three sensors as control and average for unit mode, averages the three highest temperature readings.

At the system level, using a U2U network, the same maximum or average calculations can be based on readings from all of the sensors in all of the units in group (including those in standby) using teamwork. See [Teamwork Modes](#) on page 67.

1. Touch , then  > *Auxiliary Device Setup* > *Sensors* > *Wired Remote Sensors* > *Setup*. The set up SENSOR PROPERTIES panel opens.
2. Adjust the settings for the cooling units sensor array, and touch *Save*.
[Wired Remote Sensor Setup Options](#) below, describes the setting options.
3. Touch a specific sensor. The SENSOR PROPERTIES for that sensor open.

NOTE: The sensor number listed corresponds to the DIP switch assignment of the sensor made during installation.

4. Touch *Name*, and use the keyboard to give the sensor a descriptive name.

NOTE: This is the name displayed on the REMOTE SENSORS panel for non-service users.

5. Refer to the [Wired Remote Sensor—Sensor Property Options](#) on the facing page to adjust the remaining settings, and touch *Save*. The wired-remote sensors for the cooling unit are configured.

8.2.1 Wired Remote Sensor Setup Options

Average Rack Temp

Calculated average of temperature readings from the control sensors.

Individual Remote Sensors Mode

When controlling at the sensor level, selects the method of using the readings from the two temperature thermistors (probes) on the sensor. Options are:

- Maximum: Use the highest temperature reading of the two thermistors.
- Average: Use the average of the readings from the two thermistors.

Max Rack Temp

Highest temperature reading from the unit remote sensors.

REM Sensors Set to Control

Number of sensors set to control.

Unit Remote Sensors Mode

When controlling at the unit level, selects the method of using the inlet-rack temperature readings from the control sensors to control fan speed. Options are:

- Maximum: Use the highest temperature reading of the sensors set to Control.
- Average: Use the average of the readings from the sensors set to Control and included in AVG.

Unit Remote Sensors Included in AVG

When Unit Remote Sensors Mode is *Average*, selects the number of sensors used to calculate the average temperature.

- If the number selected is smaller than the number of REM Sensors set to Control, only the highest readings are used for the calculation.

NOTE: Depending on the type of thermal management unit, included components, and control settings of your system, all of the options listed may not be available on your Vertiv™ Liebert® iCOM™ display.

8.2.2 Wired Remote Sensor—Sensor Property Options

Function

Sets the function of the sensor when Unit Remote Sensors Mode is enabled.

- Disable: Sensor readings are ignored.
- Reference: Sensor readings are considered for Max Rack Temp, but are not used in maximum/average calculations.
- Control: Sensor readings are used in maximum/average calculations.

Left Lead Current Value

Current reading of the left sensor probe. The left probe is always a temperature reading.

Left Lead Offset

Correction (calibration) value added to the reading. Used in the event that the sensor reading is incorrect.

- May be a positive or negative value.

Name

Custom, descriptive name to assist in identifying the sensor's location/function in the facility, for example, the name of the rack on which it is installed. The name is limited to:

- Up to four alphanumeric characters in length
- Upper and lower case alpha characters
- The following special characters: & * / . + - : @ \

Right Lead Current Value

Current reading of the right sensor probe. May be a temperature or humidity reading, depending on the connected sensor.

Right Lead Offset

Correction (calibration) value added to the reading. Used in the event that the sensor reading is incorrect.

- May be a positive or negative value.

9 Administering Firmware, Settings and Security

9.1 Vertiv™ Liebert® iCOM™ Firmware Upgrades

NOTE: The Liebert® iCOM™ Service Tool (iST) is required to update control board firmware. Contact technical support at 1-800-543-2778 for information on control board updates.

9.1.1 Compatibility with Earlier Versions of Liebert® iCOM™

Versions of Liebert® iCOM™-control firmware PA2.05.31R are incompatible with earlier firmware versions PA1.XX.XXXSTD.

The firmware versions PA2.05.31R and later cannot communicate with earlier versions. The Vertiv™ Liebert® DSE, Vertiv™ Liebert® Mini-Mate Variable Capacity 3 Ton, and Vertiv™ Liebert® PDX/PCW will not operate with PA1.XX.XXXSTD installed.

Contact your Vertiv™ representative to upgrade firmware.

9.1.2 Updating Liebert® iCOM™ Control Board Firmware

The FIRMWARE UPGRADE panel shows the firmware version of the control board of the cooling unit. It also includes settings to use while performing the upgrade.

NOTE: Only personnel who have completed Vertiv™ training should perform a control board update. The Liebert® iCOM™ Service Tool (iST) is required to update control-board firmware. Contact technical support at 1-800-543-2778 for information on control board updates.



1. Save the Liebert® iCOM™ software to a USB flash drive formatted with a FAT32 file system.
 - Make sure that the file name extension is all lower case. For example, *.xpb* not *.XBP*.
 - Remove all other files with the *.xpb* extension from the flash drive.
2. At the Liebert® iCOM™ control:
 - Touch , then  > Backup & Security > Firmware Upgrade. The FIRMWARE UPGRADE panel opens.
 - Make sure the *Lock for Upgrade*, is selected.
 - Refer to [Control Board Firmware Upgrade Options](#) on the next page, for the reset and retain options.
3. On the Liebert® iCOM™ control board:
 - Insert the flash drive into the P76 USB port. After a few seconds, the DS25 LED lights up green.
 - P75 does not work for firmware upgrade.
 - To continue with the upgrade, press the S3 button near the LED within 15 seconds. The LED blinks blue to indicate that the upgrade has commenced. When the upgrade completes, the LED blinks fast green, and the board reboots with the new firmware.
4. Remove the USB flash drive after the board reboots.

Figure 9.1 P76, S3, and DS25 LED on the Board



Item	Description
1	P76 port
2	DS25 LED
3	S3 button

9.1.3 Control Board Firmware Upgrade Options

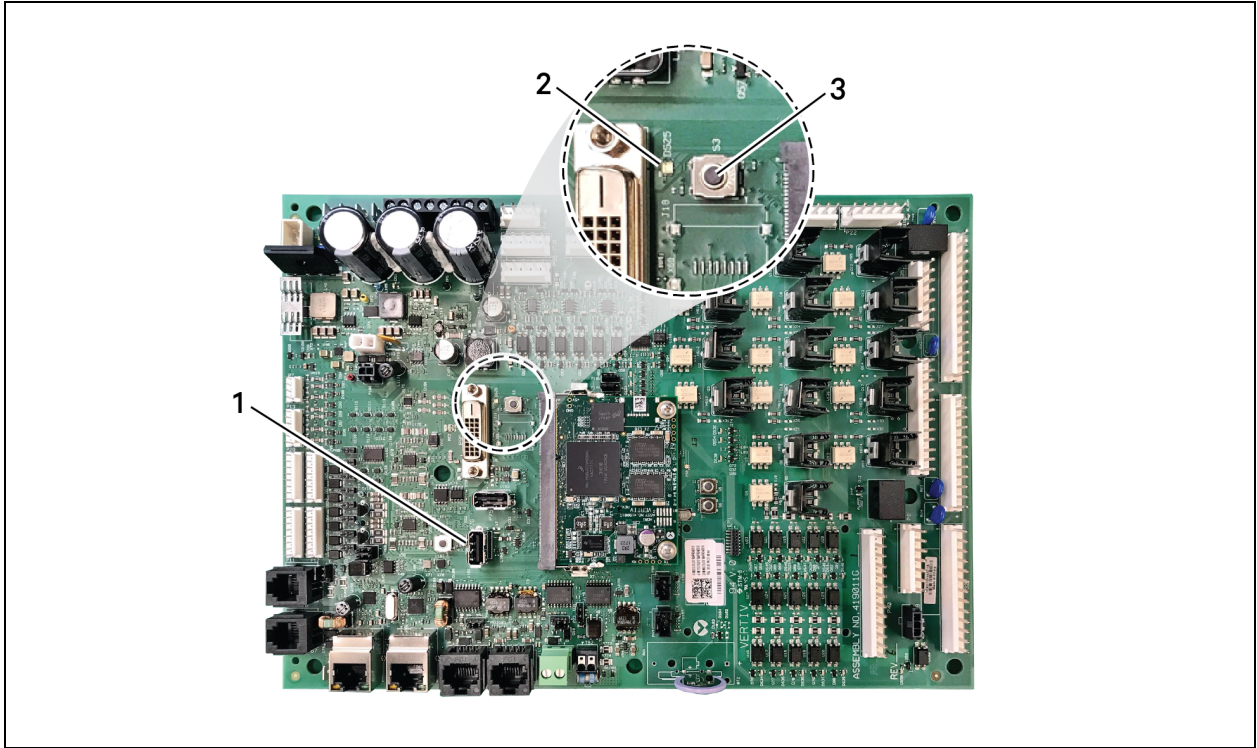
Lock for Upgrade

When selected, the unit is locked for a firmware upgrade.

Reset to Default Configuration

When selected, the unit is reset to the factory default configuration during the upgrade

Retain Network Configuration

When selected, the current network settings and options are retained while all other settings are reset to the factory default configuration.



Unlocking the Control Board Before Upgrade

If changes are made to the settings after the control board is locked for firmware upgrade, use the following steps to unlock the board and execute the changes.

1. In the *Lock for Upgrade* field on the FIRMWARE UPGRADE PARAMETERS panel, select *Unlock*, then select *Yes*.
2. Touch *Save*. The changes are executed.

9.2 Backing Up and Restoring Control Board Settings

Vertiv™ Liebert® iCOM™ settings may be saved to a local disk or USB drive, and the saved files may be imported to restore Liebert® iCOM™ if it is replaced or if a problem occurs and to transfer settings to another Liebert® iCOM™.

1. Touch , then  > *Backup & Security* > *Control Backup/Restore*. The BACKUP & RESTORE panel opens.
2. Touch the *Action Type* drop-down, and select the action to perform.
3. Select the location, site, and system to save backup files or load restore/replicate files, see [Control Board Backup and Restore Options](#) below, for descriptions.

NOTE: USB drives are automatically detected and displayed as options for Location selection.

4. Touch the action button in the lower-right corner. A notification indicates that the backup, restore, or replicate is complete.
5. Remove the USB drive from the port.

9.2.1 Control Board Backup and Restore Options

Action Type

Selects the backup or restore function. Options are:

- **Backup:** Saves a copy of the settings in a file named with the IP address of the Liebert® iCOM™ control board. Use a backup file to restore the unit settings in the event of a failure.
- **Replicate:** Loads only the configsafe files (general settings/setpoints) from a backup file from another system.
- **Restore:** Loads a backup configuration from a previously saved backup file. For example, when a control board fails and must be replaced, you can load the configuration from a backup of the failed board.

Location

Indicates the port to which the USB drive is connected.

Site

Indicates the folder you created on the USB drive to which the backup system file is saved.

System

The backup file named with the IP address of the control board from which it was saved.

9.3 Managing Access Permission and Passwords

NOTICE

Risk of loss of access to Vertiv™ Liebert® iCOM™. Can cause operational problems.



When a password is changed, make sure you record the new password and inform authorized users. If problems arise, passwords can be reset by Vertiv™ Technical Support, visit <https://www.vertiv.com/en-us/support/>.

Two four digit passwords provide two levels of permission to access Liebert® iCOM™ menus and are set with factory default values. You can change the value of each password so that only those provided with the current password may access the menus that it unlocks.

The factory-default password for user and service log in are:

- Default User password = 1490
- Default Service password = 5010

NOTE: To change the password, you must use the Service password currently assigned to unlock the Service menu.

1. Touch , then  > *Backup & Security* > *Manage Permissions*. The MANAGE PINS panel opens.
2. Touch the role to change, then touch the *Value* field for the password to change. The keypad opens.
3. Type a new four digit/character password, then touch , and touch *Save*. The password is saved. Touch *Cancel* to discard the change.

10 Performing Diagnostics

NOTE: Depending on the type of thermal management unit, included components, and control settings of your system, all of the options listed may not be available on your Vertiv™ Liebert® iCOM™ display.

10.1 Cooling Unit Status LED

Just below the Liebert® iCOM™ touchscreen display is an LED that changes color and flashes on and off to indicate cooling unit status. See **Table 10.1** below, for the LED colors and meanings.

Table 10.1 Cooling Unit LED Colors and State Meanings

State	Color(s)	Meaning
Solid	Green	Powered on and operating.
Solid	Amber	In diagnostic/service mode or powered off.
Solid	Red	Active warning or alarm present and acknowledged.
Flashing	Amber/Green	In sleep or U2U standby mode and available to operate.
Flashing	Red/Green	Operating with an active warning or alarm.
Flashing	Amber/Red	Shut down (not operating) because of an unacknowledged alarm.
Flashing	Red	Active warning or alarm present but unacknowledged.
Flashing	Blue	Liebert® iCOM™ display is starting up or updating Liebert® iCOM™ firmware.



10.2 Enabling Manual Mode for Diagnostics

Use manual mode to test components, validate operation, and evaluate performance.



NOTE: When manual mode is enabled, the cooling unit does not operate normally:

- Fan operation depends on the diagnostic category in use.
- Safety routines will prevent the use of some diagnostic features.
- Active alarms may prevent some the use of some diagnostic functions.
- In most cases, all components are turned off.



NOTE: When manual mode is disabled, all components and the cooling unit return to normal operation. See [Disabling Diagnostics Manual Mode](#) on the next page. Manual mode will time out after 30 minutes of inactivity and normal operation resumes.

1. Touch , then  > *Diagnostic/Service* > *Diagnostics* > *Manual Mode* in the Category list. The MANUAL MODE panel displays.
2. Touch the *Enable* check box in the upper-right of the *MANUAL MODE* panel. The MANUAL MODE confirmation dialog opens.
3. Touch *OK* to enable manual mode. Enable is checked and manual control for diagnostics enabled.
 - Touch *Cancel* to close the dialog and manual mode remains disabled.

10.2.1 Disabling Diagnostics Manual Mode

1. Touch , then  > *Diagnostic/Service* > *Diagnostics* > *Manual Mode* in the Category list. The MANUAL MODE panel displays.
2. Remove the check mark from the *Enable* box by touching it. Manual mode is disabled.

10.3 Diagnosing Evaporator Fan Issues

1. Touch , then  > *Diagnostic/Service* > *Diagnostics* > *Evaporator Fan* in the Category list. The EVAPORATOR FAN panel displays.
2. Refer to [Diagnostics—Evaporator Fan Options](#) below, for descriptions of diagnostic options.

NOTE: Depending on the type of thermal management unit, included components, and control settings of your system, all of the options listed may not be available on your Liebert® iCOM™ display.

10.3.1 Diagnostics—Evaporator Fan Options

Analog Output 1

0V to 10V analog output that drives the speed of the evaporator fan. Typically, the evaporator fan is Analog Output 1 by default.

Analog Output 1 Selection

Var SpeedDrive.

Fan Speed

Current speed of fan.

Motors

Enables/disables fan motor during manual/diagnostic mode.

Status Airflow

Indicates if the status of the Air Safety Switch is open or closed.



Status Filter

Status of the air filter.

Status Remote Shutdown

Indicates whether remote shutdown is on or off.

10.4 Diagnosing Compressor Circuit Issues

1. Touch , then  > *Diagnostic/Service* > *Diagnostics* > *Compressor Circuit N* (where “N” is the circuit number) in the Category list. The COMPRESSOR CIRCUIT panel displays.
2. Refer to [Diagnostics—Compressor Circuit Options](#) below, for descriptions of diagnostic options.

NOTE: Depending on the type of thermal management unit, included components, and control settings of your system, all of the options listed may not be available on your Vertiv™ Liebert® iCOM™ display.

10.4.1 Diagnostics—Compressor Circuit Options

Compressor Capacity

Enables/disables compressor capacity during manual/diagnostics mode.

Compressor Cycle Ramp

Capacity at which compressor runs in manual mode.

Compressor Freeze Protection

Indicates whether freeze protection influences compressor capacity (On) or not (Off), based on low pressure values.

Compressor Mode

Selects compressor operation during manual/diagnostics mode. Options are:

- 0: Run (normal operation)
- 1: Evacuate
- 2: Charge

Compressor Overload

Compress overload status. Not applicable to Mini-Mate.

Compressor State

Compressor status, On or Off.

Fan Freeze Protection

Indicates whether freeze protection influences fan speed (On) or not (Off), based on low pressure values.

High Pressure Alarm Code

Code of high-pressure alarm. To address the alarm condition, see [Resetting High Pressure Alarm Code](#) on the next page.

- 0: Okay
- Non-zero: High head pressure situation.

High Pressure Status

Status of compressor's high pressure switch.

High Temperature Alarm Counter

Number of high temperature alarm events. To address the alarm condition, see [Resetting High Temperature Alarm Counter](#) on the facing page

Low Pressure Alarm Code

Code of low-pressure alarm. To address the alarm condition, see [Resetting Low Pressure Alarm Code](#) on the facing page .

- 0: Okay.
- Non-zero: Low suction pressure condition.

Low Pressure Status

Status of compressor's low pressure switch.

Status HT1

Count of times compressor is powered off for high scroll temperature.



Suction Pressure

Current pressure of the compressor suction.

10.4.2 Resetting High Pressure Alarm Code

When a high pressure problem has caused a compressor to lock off, resetting the High Pressure Alarm Code to zero unlocks the compressor for operation.

NOTE: Cycling main power of the cooling unit will also unlock the compressor.

1. Touch  , then  > *Diagnostic/Service* > *Diagnostics* > *Compressor Circuit N* in the Category list (where "N" is the circuit number).
2. On the COMPRESSOR CIRCUIT panel, touch *Set to Zero* next to High Pressure Alarm Code, then touch *Save*. The code is reset and the compressor can now operate.



10.4.3 Resetting Low Pressure Alarm Code

When a low pressure problem has caused a compressor to lock off, resetting the Low Pressure Alarm Code to zero unlocks the compressor for operation.



NOTE: Cycling main power of the cooling unit will also unlock the compressor.

1. On the Service menu, touch *Diagnostic/Service* > *Diagnostics*. The DIAGNOSTICS panel opens.
2. Touch *Compressor Circuit N* in the Category list (where “N” is the circuit number).
3. On the COMPRESSOR CIRCUIT panel, touch *Set to Zero* next to Low Pressure Alarm Code, then touch *Save*. The code is reset and the compressor can now operate.

10.4.4 Resetting High Temperature Alarm Counter

1. Touch , then  > *Diagnostic/Service* > *Diagnostics* > *Compressor Circuit N* in the Category list (where “N” is the circuit number).
2. On the COMPRESSOR CIRCUIT panel, touch *Set to Zero* next to High Temperature Alarm Counter, then touch *Save*. The code is reset and the compressor can now operate.

10.5 Diagnosing Reheat Issues

1. Touch , then  > *Diagnostic/Service* > *Diagnostics* > *Reheat* in the Category list. The REHEAT panel displays.
2. Refer to [Diagnostics—Reheat Options](#) below, for descriptions of diagnostic options.

NOTE: Depending on the type of thermal management unit, included components, and control settings of your system, all of the options listed may not be available on your Vertiv™ Liebert® iCOM™ display.

10.5.1 Diagnostics—Reheat Options



Analog Output 1 – 4

0V to 10V analog outputs that operate reheat.

Electric Heat N

Enables/disables heaters in manual/diagnostic mode (where N = electric heat number).

10.6 Diagnosing Humidifier Issues

1. Touch , then  > *Diagnostic/Service* > *Diagnostics* > *Humidifier* in the Category list. The HUMIDIFIER panel displays.
2. Refer to [Diagnostics—Humidifier Options](#) below, for descriptions of diagnostic options.

NOTE: Depending on the type of thermal management unit, included components, and control settings of your system, all of the options listed may not be available on your Liebert® iCOM™ display.

10.6.1 Diagnostics—Humidifier Options

Humidifier

Enables/disables humidification in manual/diagnostic mode.

Humidifier Drain

Enables/disables humidifier drain. Does not apply to Vertiv™ Liebert® Mini-Mate Variable Capacity 3 Ton.



Local Hum PI

Current humidity PI percentage. Does not apply to Liebert® Mini-Mate Variable Capacity 3 Ton.

Status Humidifier Problem

Current status of the humidifier. OK indicates that the status is good.

10.7 Diagnosing Digital Output Issues

1. Touch , then  > *Diagnostic/Service* > *Diagnostics* > *Digital Outputs* in the Category list. The DIGITAL OUTPUTS panel displays.
2. Refer to [Diagnostics—Digital Output Options](#) below for descriptions of diagnostic options.

NOTE: Depending on the type of thermal management unit, included components, and control settings of your system, all of the options listed may not be available on your Vertiv™ Liebert® iCOM™ display.

10.7.1 Diagnostics—Digital Output Options

Alarm Relay

Enables/disables alarms during manual/diagnostic mode.



K11 Relay

Enables/disables warnings during manual/diagnostic mode.

Q15 Output State

Enables/disables Q15 output during manual/diagnostic mode.

10.8 Diagnosing Analog Output Issues

1. Touch , then  > *Diagnostic/Service* > *Diagnostics* > *Analog Outputs* in the Category list. The ANALOG OUTPUTS panel displays.
2. Refer to [Diagnostics—Analog Output Options](#) below, for descriptions of diagnostic options.



NOTE: Depending on the type of thermal management unit, included components, and control settings of your system, all of the options listed may not be available on your Vertiv™ Liebert® iCOM™ display.

10.8.1 Diagnostics—Analog Output Options

Analog Output N

Controls analog outputs during manual/diagnostic mode. (*Where N is the analog output number.*)

10.9 Diagnosing Customer Input Issues

1. Touch , then  > *Diagnostic/Service* > *Diagnostics* > *Customer Inputs* in the Category list. The CUSTOMER INPUTS panel displays.
2. Refer to [Diagnostics—Customer Input Options](#) below, for descriptions of diagnostic options.

NOTE: Depending on the type of thermal management unit, included components, and control settings of your system, all of the options listed may not be available on your Vertiv™ Liebert® iCOM™ display.

10.9.1 Diagnostics—Customer Input Options



Input N

Status and description of customer-input sensors. (Where N is the input number.)

11 Customizing Your Vertiv™ Liebert® iCOM™ Display

11.1 Setting General Display Properties

NOTE: You must be logged in to adjust the settings. See [Powering On the Vertiv™ Liebert® iCOM™ and Logging In/Unlocking Controls](#) on page 6 .

1. Touch , then  > *Display Options* > *Display Properties*. The DISPLAY PROPERTIES panel opens.
2. Touch a value to select the setting from the drop-down list
3. Touch Save to save the property settings.
 - Touch *Cancel* to discard changes.

11.1.1 Unit Display Options

Alarm Buzzer Pattern

Selects or disables the audible alarm notification. See [Enabling the Audible Alarm Notification](#) on page 59 .

Allow System On/Off

Enables/disables powering on/off the entire system of networked units from the Liebert® iCOM™ display.

Backlight Brightness

Selects the brightness of the display back light.

Inactivity Timer

Time to elapse before display locks and dims.

Language

Selects the display language.

LED Brightness

Percentage brightness of the display.

Measurement System

Selects the units of measurement. Options are:

- Imperial (°F)
- Metric (°C)

Skin

Selects the color/background format of the user interface. Options are:

- Dark Blue
- White
- Dark Grey

Touch Beep

Enable/disable sound when display is touched.

Touch Shock wave

Enable/disable visual shock wave when display is touched.

Turn Unit On/Off without Password

When enabled, a Power On/Off button displays in the upper-right corner of the Vertiv™ Liebert® iCOM™ main display so personnel can turn the unit on or off with out logging-in and accessing the User/Service menus.



11.2 Customizing Main Display Views

The default Liebert® iCOM™ display view is essentially a layout of two panels, one with status content and the other with alarms content. You can create custom display views by adding, changing, moving, and resizing the content objects.

NOTE: You must be logged in to customize the view. See [Powering On the Vertiv™ Liebert® iCOM™ and Logging In/Unlocking Controls](#) on page 6 .

11.2.1 Moving Content

You can drag and drop content objects anywhere you like on the main display.

1. Touch  , then  .
2. Touch  in the upper right corner of the display and just below the control header.
3. Touch an object to select it (highlighted green), and drag it to the new location.

11.2.2 Resizing Content

You can resize content objects on the main display.



1. Touch  , then  .
2. Touch  in the upper right corner of the display and just below the control header.
3. Touch an object to select it (highlighted green), touch and drag a handle to re-size the object, see **Figure 11.1** on the facing page .

Figure 11.1 Add/Remove Content Icons and Resizing Handles



Item	Description
1	Content adjustment icon
2	Resizing handles
3	Remove content icon

11.2.3 Adding and Adjusting Content

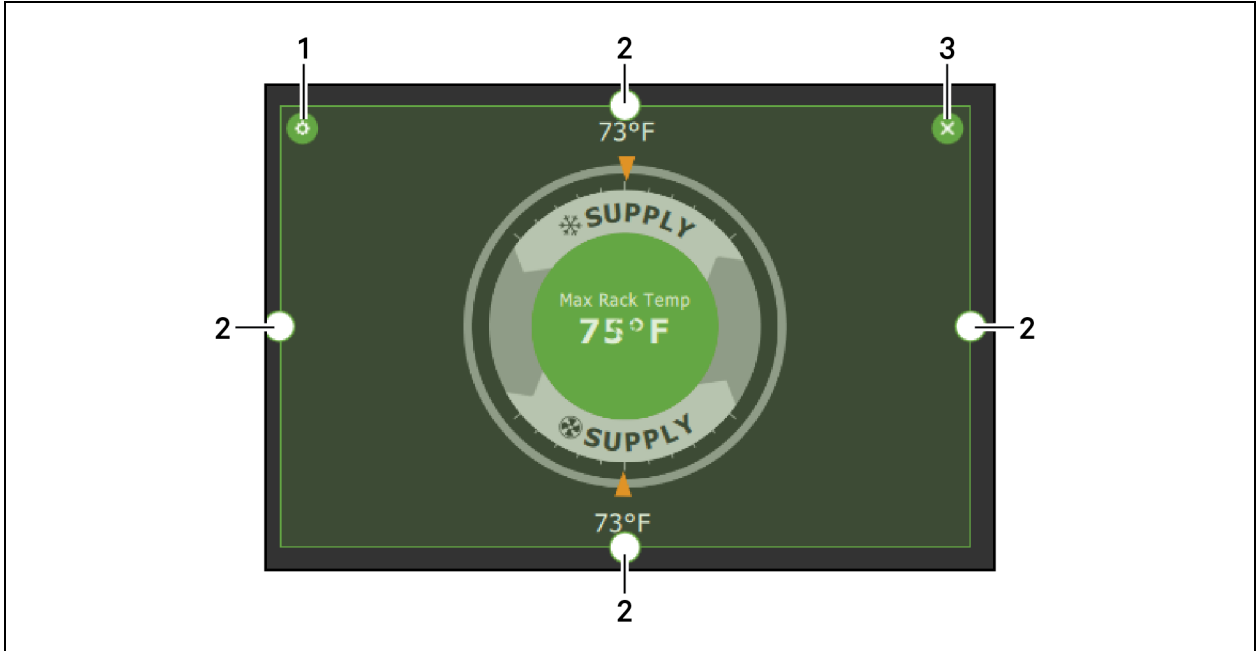
You can add a variety of content to the main display.







1. Touch , then .
2. Touch  in the upper-right corner of the display and just below the control header, then touch . A menu of content options opens, described in **Table 11.1** on the next page.
3. Touch the Move icon next to the content and drag it onto the display, then use the re-size handles to adjust as needed.
4. To adjust the content object or the way that it displays, touch , see **Figure 11.1** above.

Table 11.1 Main/User Display Content Options

Content	Description
Separator	Separating line to place between content sections. You can adjust the thickness and orientation of the separator.
Dial	Status dial. You can select the sensor readings displayed in the center of the status dial when you touch to scroll through the readings.
Setpoint Readout	Displays the current reading of a connected sensor, for example: Return-temperature at 72°F.
Setpoint Bar	Displays a bar graph for a selected setpoint with customizable empty and full limits. For example, if a temperature setpoint bar is empty at 60°F and full at 80°F, and the reading is 70°, the graph will be filled half way.
Sensor Bar	For remote sensors only, functions the same as the setpoint bar, but only offers connected remote sensors, and displays the customer assigned name of the sensor next to the graph.
Shortcut	Shortcut opens panels directly instead of browsing through menus. You can select the destination of the shortcut, whether or not an icon displays, and the size, label, and frame of the shortcut.
Alarms	Alarms panel. You can select whether or not the information may be exported.
Event Log	Event log panel. You can select whether or not the information may be exported.
Run Hours	Run hours panel. Summary of the component run hours and limits.
EconoPhase Diagram	EconoPhase operating diagram.
EconoPhase Status	Compressor/EconoPhase status bar. Indicates the operating mode and the percentage at which the component is operating.

11.2.4 Removing Content



You can easily remove content from the main display.

1. Touch  , then .
2. Touch  in the upper right corner of the display and just below the control header.
3. Touch an object to select it (highlighted green), then touch  , see **Figure 11.1** on the previous page .

11.3 Customizing Parameter and Field Labels

You can customize header labels for parameters in the menus and you can customize field names.

NOTE: You can export labels for backup or to use a text editor to customize the labels. See [Exporting, Importing and Customizing Labels Using a Text Editor](#) on page 132 .

1. Before going to the customization panel, use the search box and on-screen keyboard to find the label(s) that you want to customize. Once you know where they are, you'll be able to find them in the categories on the Customize Labels panel.
2. Touch  , then  > *Display Options* > *Custom Labels*. The CUSTOM LABELS panel opens. The labels are divided into categories that represent the names of menus, sub-menus, and screen panels.

3. Locate the category that contains the label(s) to customize that you determined in step 1, and touch to expand it.
4. In the Custom Text column, touch the text box to edit, make changes and touch . See **Figure 11.2** below, for an example of changing the column names for Property and Value (in the Analog Inputs panel) to Input and Configuration.
 - Touch *Cancel* to discard the change.
5. When finished editing labels, make sure the Enable Custom Labels is selected (or your updates will not display), and touch Save. The label(s) are updated. **Figure 11.3** on the next page, shows the Analog Input Properties panel with the custom labels that replaced Property and Value.”

Figure 11.2 Custom Text for the Analog Input Properties Labels

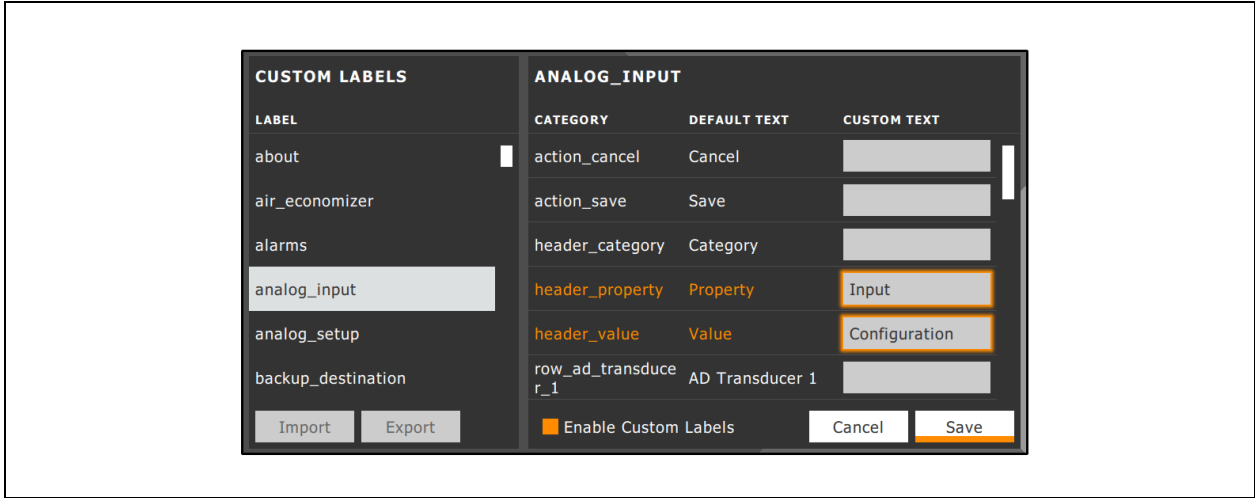
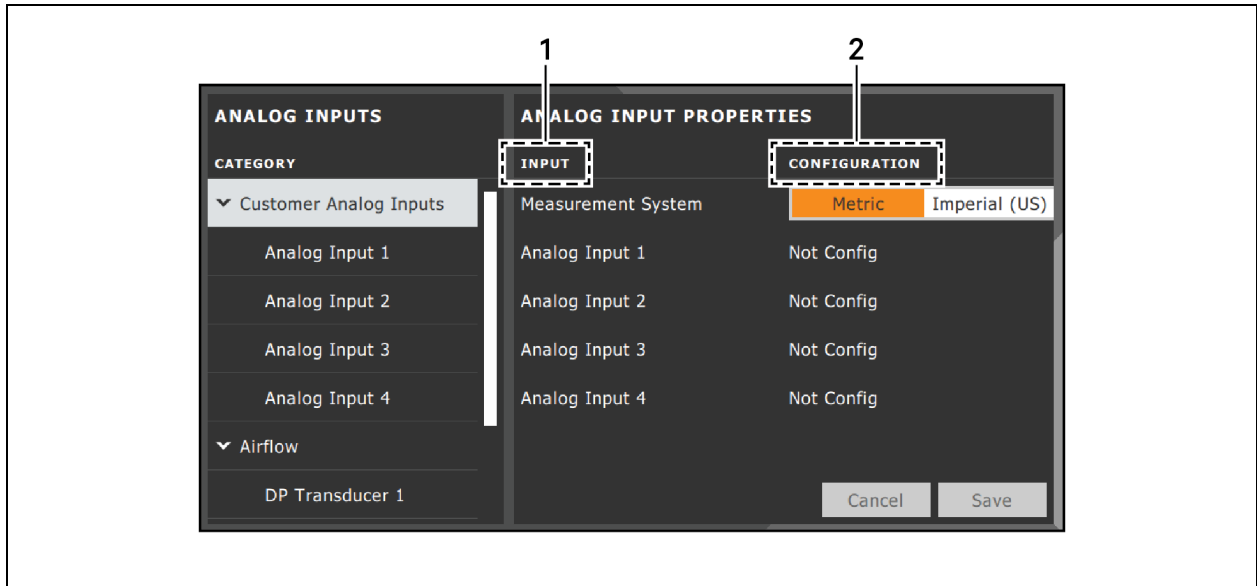

Figure 11.3 Customized Label Text on Analog Input Properties Panel



Item	Description
1	Former Parameter heading is now Input.
2	Former Value heading is now Configuration.

11.3.1 Exporting, Importing and Customizing Labels Using a Text Editor

You can export custom label settings to a text file for back up or to modify the labels using a text editor. The text file is exported and imported using a USB drive.

1. Insert a USB drive into an open USB port on the rear of the touchscreen display, then navigate to the Custom Labels panel and touch *Export*. The EXPORT FILE dialog opens, and the connected USB drive is automatically detected.
 - If you are prompted No USB devices are available, check the connection or try reinserting the drive.
2. Touch *Name* and type a descriptive name for the file, then touch *Go*.
3. Touch *Export* and wait at least 15 seconds, then you can remove the USB drive.
4. Insert the USB drive into a PC or laptop and locate the file, which is named with the Name you entered and the extension *.cl.txt*. For example, if you named your export *MyLabels*, the file will be *MyLabels.cl.txt*.
5. Open the file in a text editor. The file contains all of the labels available for customization listed with the menu/panel on which the label is located, the label identifier, and an equal sign (=) as shown in the following example:

NOTE: You must use an editor that interprets Linux line endings, otherwise all of the lines will run together. For example, Microsoft WordPad will interpret the Linux line endings but Microsoft Notepad will not.

```
analog_input/row_customer_analog_inputs=Unit A Inputs
analog_input_properties/header_property=Property
analog_input_properties/header_value=Value
```

- To customize, type a new label name to the right of =, and save the text file.
The following example will result in the same custom labels shown in **Figure 11.3** on the previous page.

```
analog_input/row_customer_analog_inputs=Unit A Inputs
```

```
analog_input_properties/header_property=Input
```

```
analog_input_properties/header_value=Configuration
```

- Remove the USB drive with the updated/saved text file from the PC or laptop, insert it into an open USB port on the rear of the touchscreen display, then navigate to the Custom Labels panel and touch *Import*.
- Locate the updated text file in the drop-down list, and touch *Import*. The dialog closes and the customizations display on the menus and panels that you updated.

This page intentionally left blank

12 Vertiv™ Liebert® iCOM™ Hardware Installation

Your unit includes the Liebert® iCOM™ controller. This section describes the installation of connections and cabling to fully utilize the Liebert® iCOM™ features.

12.1 Return Air Temperature/Humidity Sensor

The return temperature/humidity sensor is located in the unit return air section and is supplied on all Liebert systems with Liebert® iCOM™ controls. The assembly connects to plug connection P67 on the iCOM internal control board on all DS, CW, DSE systems and plug P451 located on EEV #1 control board on the PDX unit.

Troubleshooting is accomplished by observing a green LED located on the sensor internal control board. If the LED is solid green, the sensor is communicating properly with the iCOM controller. If the LED is continuously flashing green, the sensor is not communicating properly and the P3 CANbus termination should be verified that it is properly terminated. No LED indicates the sensor does not have power present.

Figure 12.1 Temperature/Humidity Sensor Internal Control Board

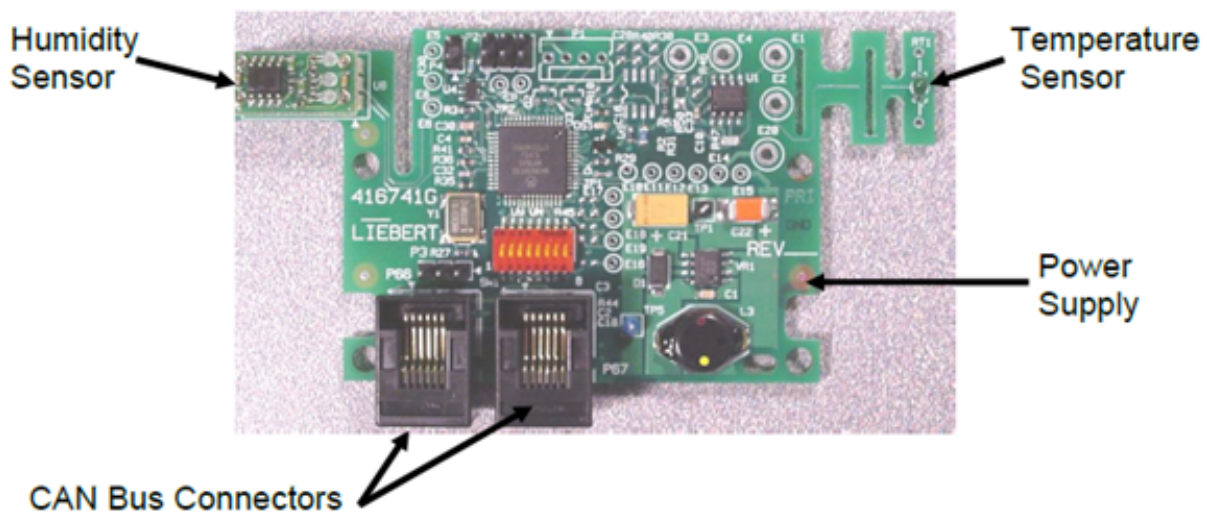

12.1.1 P67: Return Air Temperature—Humidity Board

P67-1: CAN communication.

P67-6: CAN communication.

Figure 12.2 Standard Return Air Sensor

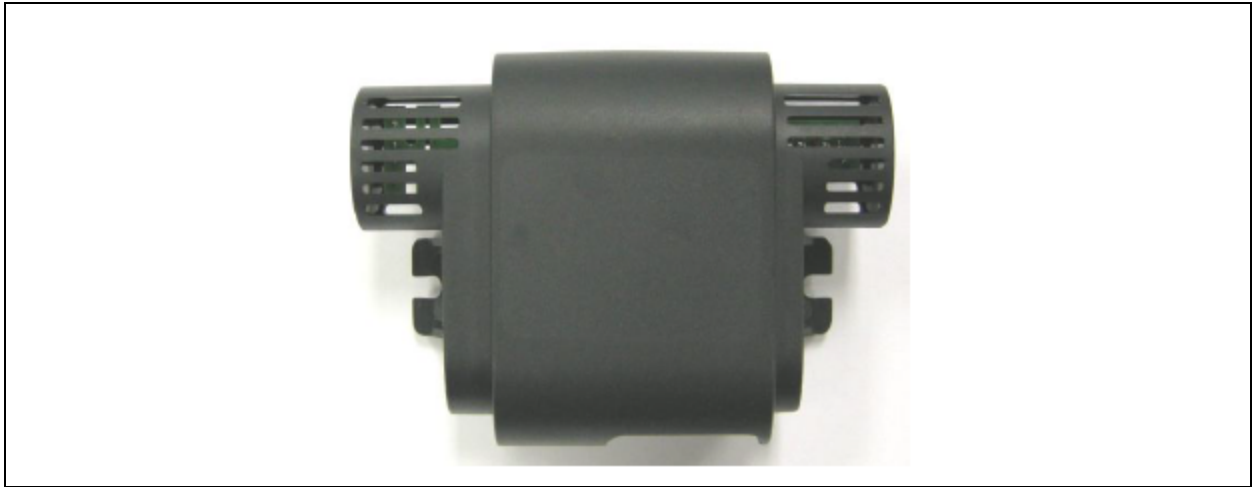

Figure 12.3 Optional Remote Sensor A, B, C



Figure 12.4 Temperature/Humidity Sensor with Dip Switch/Jumper Settings

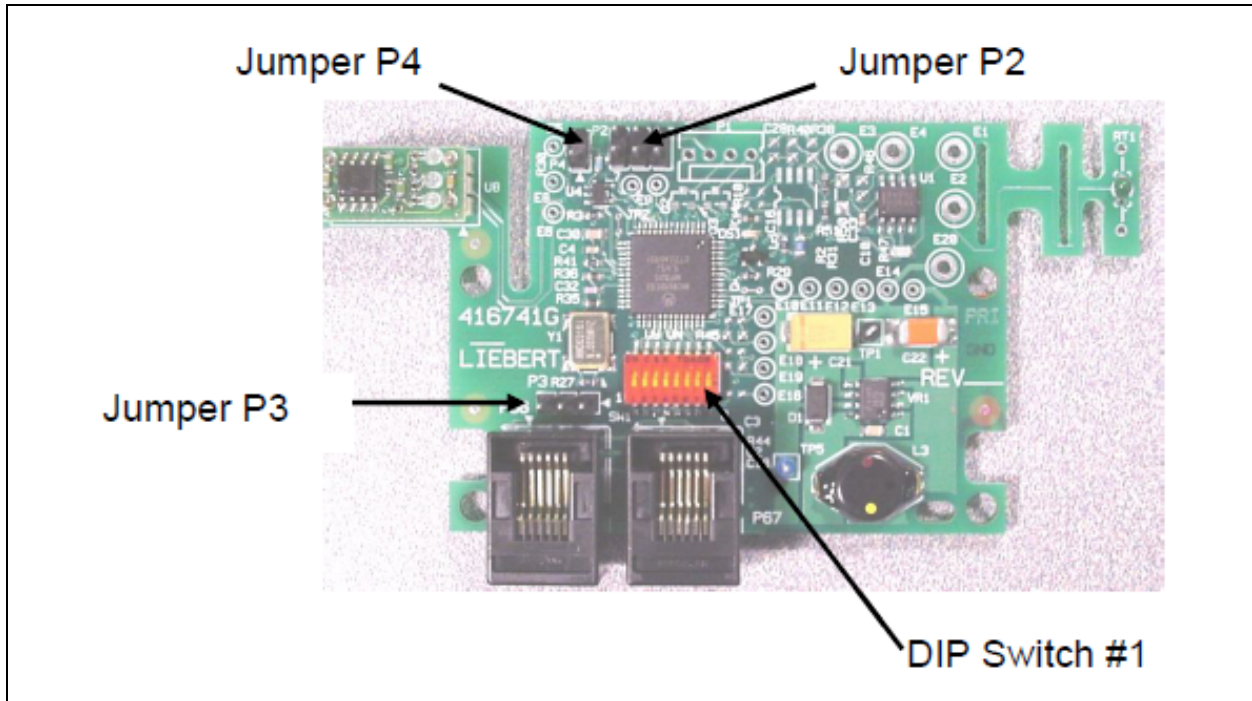

Table 12.1 Temperature/Humidity Sensor Dip Switch Settings

Sensor	Pos. #1	Pos. #2	Pos. #3	Pos. #4	Pos. #5	Pos. #6	Pos. #7	Pos. #8
Return T/H Sensor	Off	Off	Off	Off	Off	Off	Off	Off
Optional Sensor A	On	Off	Off	Off	On	Off	Off	Off
Optional Sensor B	Off	On	Off	Off	On	Off	Off	Off
Optional Sensor C	On	On	Off	Off	On	Off	Off	Off

Table 12.2 Temperature/Humidity Sensor Jumper Settings

Jumper Label	Type	Position
P2	BDM Header	*Open
P3	CANbus Termination	*Shunt on Pins 2 and 3
P4	Programming	*Open
E10-E13	Serial Port	*Open
*Factory default positions and settings.		

12.1.2 Jumper P3 CANbus Termination

The correct position of this jumper is dependent on your system configuration. If the sensor is physically the first or last node in the CANbus device loop, the jumper must be terminated or shunted across pins #2 and #3 (default position). If the sensor is a middle node in the CANbus device loop, the jumper must be unterminated or shunted across pins #1 and #2.

12.2 Installing the U2U Network

12.2.1 Required Network Equipment

Ethernet cable CAT5 or greater:

- Maximum cable length is 328 ft (100 m).
- An Ethernet repeater is required for cable lengths greater than 328 ft (100 m).

Network switch:

- IEEE 802.3; IEEE 802.3u
- 10/100 Mbps speed
- Multiple 10/100 RJ 45 ports, one shared.
- RJ 45 up link port

NOTE: Up to 32 cooling units may be connected in a U2U network.

12.2.2 Planning Wiring Runs

When planning the layout of the conditioned space, consider the following:

- Good wiring practices.
- An Ethernet repeater is required for cable lengths greater than 328 ft. (100 m).
- A private network that only connects and manages the cooling units is required.
- Keep control and communication cables away from power cables to prevent electromagnetic interference.
- Keep cables away from noise introducing devices such as machines, fluorescent lights, and electronics.
- Do not bend cables to less than four times the diameter of the diameter of the cable.
- Do not deform cables when hanging or securing in bundles.
- Do not exceed 25 lb. (11 kg) of tension when pulling cables to avoid stretching.
- Do not damage cables when securing them. Use only approve hangers, such as telephone wire/RG 6 coaxial-wire hangers.

12.2.3 U2U Wiring Connections

NOTICE

Cooling units are factory wired for stand alone operation. Do not connect the U2U network cabling before setting the U2U network configuration/groups. Network communication conflicts and unreliable display readings will result.

Before you begin, refer to [Preparing for U2U Group Set Up](#) on page 63 , and [Configuring U2U Network Settings](#) on page 64 .

– or –

Contact Vertiv Technical Support at 1-800-543-2778 or <https://www.vertiv.com/en-us/support/>.

U2U Network Requirements

The network must be private.

- Isolate from other network traffic.
- Switches connecting the units must be dedicated to Vertiv™ Liebert® iCOM™ communication only.
- Do not connect the U2U network to the building or IT network. If the U2U network experiences a failure, the cooling units continue to operate independently.

Liebert® iCOM™ supports up to 64 nodes on the U2U network. The following are considered nodes:

- Input/output board (one in each cooling unit)
- Large wall mount display

Small touchscreen displays on the cooling unit are not considered nodes because they are directly connected to the input/output board in the unit, not the network.

Of the 64 nodes, up to 32 may be cooling unit input/output boards connected as a group. **Table 12.3** below , provides U2U network-configuration examples.

Table 12.3 Example Liebert® iCOM™ U2U Network Configurations

Configuration Example	No. of Input/Output Boards (Cooling Units)	No. of Wall Mount Displays	Private Switch Required?
A	2	0	No
B	2	1	Yes
C	3	0	Yes
D	8	1	Yes
E	32	5	Yes
F	32	32	Yes

12.2.4 Wiring Cooling Units without Wall Mount Displays

NOTE: Cooling units are factory wired for stand alone operation. Do not connect the U2U network cabling before setting the U2U network configuration/groups. Network communication conflicts and unreliable display readings will result.

NOTE: Before you begin, refer to [Preparing for U2U Group Set Up](#) on page 63 , and [Configuring U2U Network Settings](#) on page 64 .

- Connect a crossover CAT5 cable to the ETH-2 connector on the rear of each display as shown in [Figure 12.5](#) below .

Figure 12.5 Connection Between Only Two Cooling Units, No Network Switch Needed

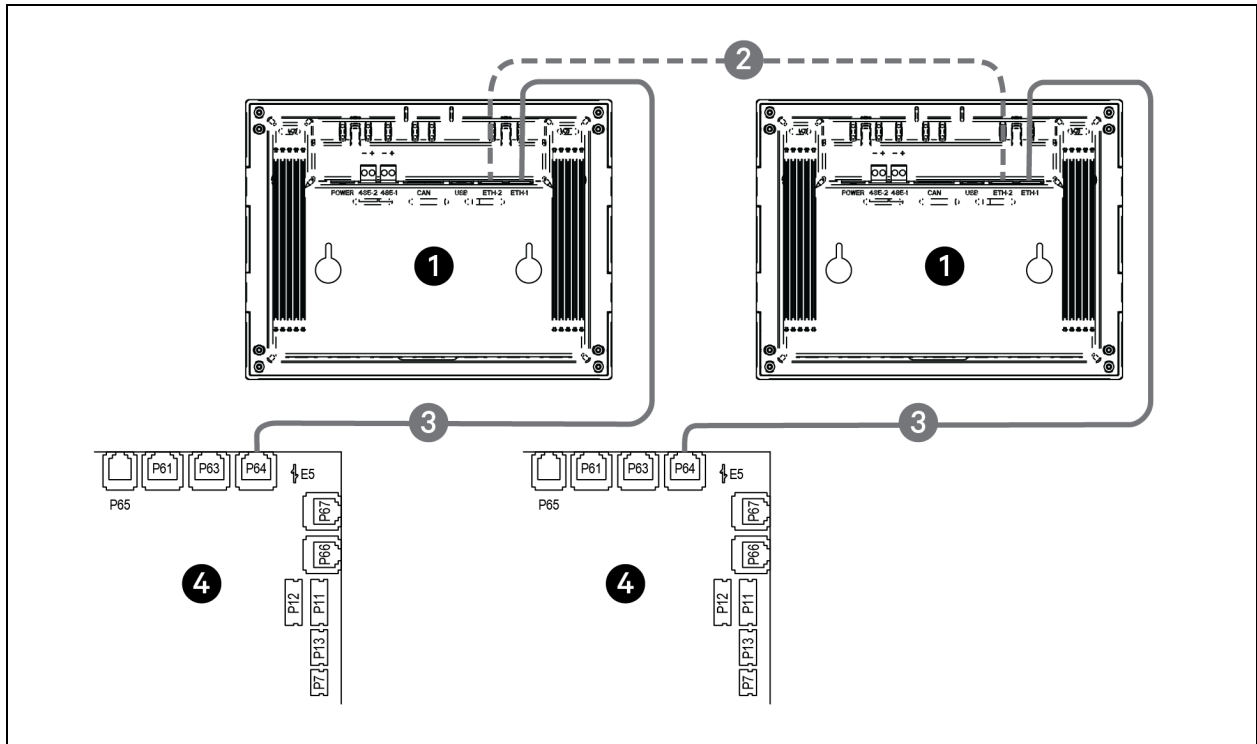

Item	Description
1	Touchscreen (rear view)
2	Ethernet cable (field supplied)
3	Ethernet cable (factory supplied)
4	iCOM I/O board

- On each unit, connect one plug on the CAT5 cable to ETH-2 on the rear of the display, and the other to the network switch, see **Figure 12.6** below .

Figure 12.6 Connecting Two or More Units with a Network Switch

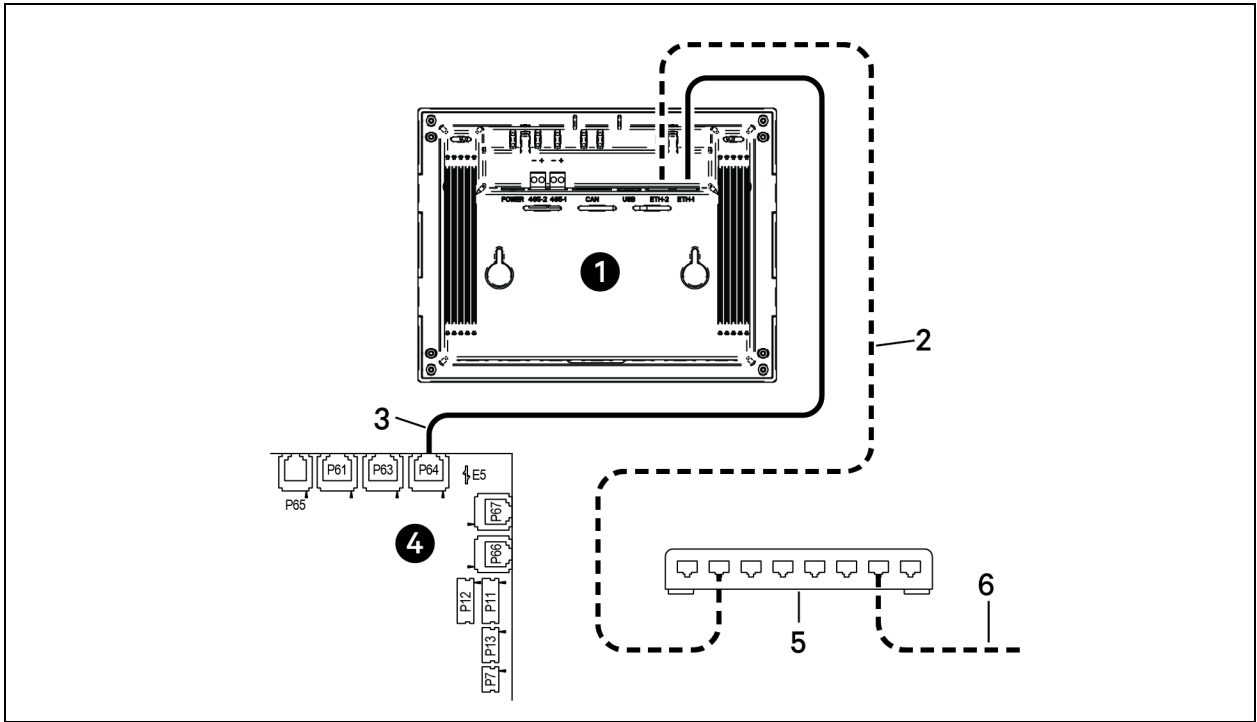

Item	Description
1	Touchscreen (rear view)
2	Ethernet cable (field supplied)
3	Ethernet cable (factory supplied)
4	iCOM I/O board
5	Network switch (field supplied)
6	to ETH-2 on rear of other cooling unit touchscreens

12.2.5 Wiring Cooling Units with Wall Mount Displays

NOTE: Cooling units are factory wired for stand-alone operation. Do not connect the U2U network cabling before setting the U2U network configuration/groups. Network communication conflicts and unreliable display readings will result.

NOTE: Before you begin, refer to [Preparing for U2U Group Set Up](#) on page 63 , and [Configuring U2U Network Settings](#) on page 64 .

Large, wall mount displays may be used to remotely configure, control and monitor all cooling units connected on the U2U network.

- Each display requires 120 VAC or 230 VAC input power.
- An AC adapter wall plug is factory supplied.

To Connect Wiring

1. On each wall mount display (32 maximum), connect one plug of a straight through Ethernet cable to port P64 on the rear of the display.
2. Connect the other end to the U2U network switch.

Appendices

Appendix A: Technical Support and Contacts

A.1 Technical Support/Service in the United States

Vertiv Group Corporation

24x7 dispatch of technicians for all products.

1-800-543-2378

Liebert® Thermal Management Products

1-800-543-2378

Liebert® Channel Products

1-800-222-5877

Liebert® AC and DC Power Products

1-800-543-2378

A.2 Locations

United States

Vertiv Headquarters

505 N. Cleveland Ave.

Westerville, OH 43082, USA

Europe

Via Leonardo Da Vinci 8 Zona Industriale Tognana

35028 Piove Di Sacco (PD) Italy

Asia

7/F, Dah Sing Financial Centre

3108 Gloucester Road

Wanchai, Hong Kong



This page intentionally left blank

Appendix B: Setpoints and Alarm Settings by Line ID

These tables list the parameters by the line identification assignments employed before the Vertiv™ Liebert® iCOM™ touchscreen. The tables include range/options of the parameter, the factory-default setting, and a description of the parameter function.

The line IDs are not listed in the User or Settings menus, only in the parameter directory. You can search the parameter list to find the line ID and its associated label and value in the Liebert® iCOM™ user interface.

B.1 To Search the Parameters List

1. Log-in at the Service level, then touch  >  > Parameter Directory.
2. Enter a line ID or term in the Search field, and touch .

B.2 Line IDs for Setpoint Parameters

Table B.1 Use Menu Setpoints by Line ID

Line ID	Parameter Name	Range	Default Setting	Description
U102	Temperature Setpoint Act	32 - 113 °F 0.0 - 45.0 °C	73 °F 23.0 °C	Selects the temperature that the cooling unit will maintain by applying cooling and/or reheats. The Temp Set value is the temperature that has been set by the User to control the temperature. The Temp Act value is a read-only value that indicates if another routine, such as supply compensation, has internally modified the temperature controlling value. If compensation has not be activated, the ACT and SET values will always match.
	Temperature Setpoint	41 - 104 °F 5.0 - 40.0 °C	73 °F 23.0 °C	
	TempSetUsr	41 - 104 °F 5.0 - 40.0 °C	73 °F 23.0 °C	
U103	Temperature Control Sensor	Supply Sensor Remote Sensor Return Sensor	Return Sensor	Selects the sensor that will control the cooling capacity; chilled water valve, compressors, free cooling valve, or air economizer. Unloading type compressors can be set to any type of sensor, however, fixed style compressors can only be set to Return or Remote sensors.
U104	Humidity Dew Point Setpoint	41 - 65 °F 5.0 - 18.3 °C	48°F 8.9 °C	Selects a humidity level that the cooling unit will maintain by removing or adding moisture to the air. The humidity setpoint will be represented in %RH or Dew Point value depending on what the humidity control type is set for.
	Humidity Setpoint	20 - 80 %RH	50 %RH	
U105	Humidity Control Sensor	Remote Sensor Return Sensor	Return Sensor	Defines which humidity value the setpoint will be compared with. The return sensor is equipped with Temp/Humidity sensor and can calculate the dew point based on the iCOM internal lookup table. If a sensor other than the return sensor is selected, the iCOM will calculate the correct %RH based on the sensor selected and its actual temperature reading.
U106	Humidity Control Type	Relative Compensated Predictive Dew Point	Predictive	Selects the humidity control calculation. If set to Relative, the unit will control the humidity without considering any temperature deviations. If set to Predictive and Absolute, the control will consider the temperature deviation from temperature setpoint so that a constant level of moisture is kept in the area based on the humidity sensor reading and the temperature deviation from setpoint. Dew Point allows the iCOM controller to calculate

Table B.1 Use Menu Setpoints by Line ID (continued)

Line ID	Parameter Name	Range	Default Setting	Description
				the actual dew point of the space and to control the humidity based on a user entered dew point temperature.
U107	Fan Setpoint	41 - 104 °F 5.0 - 40.0 °C	73 °F 22.8 °C	Required anytime the fan operates from a different sensor than that used for the temperature setpoint. For example, the temperature setpoint is set to Supply Air and the fan control is set to Remote Air. This is considered Optimized Aisle control which decouples the fan and cooling capacity modulation. The remote sensor setpoint would modulate the fan speed and the supply sensor setpoint would modulate the cooling.
U108	Fan Control Sensor	Supply Sensor Remote Sensor Return Sensor Manual	Disabled	Determines which sensor will control the speed of the fan. If set to Manual, then the fan control can be set through the local iCOM display or through the BMS system.
U110	Optimized Aisle Enabled	Disabled Enabled	Disabled	This read-only value indicates if the Liebert® iCOM™ controller is setup in a Optimized Aisle configuration. To enable optimized aisle via the iCOM display, the Supply Air sensor must be set to control the cooling capacity and the remote sensor must be set to control the fan speed. This allows the cooling unit to maintain rack temperatures while still maintaining an even under floor air temperature when controlling unbalanced rooms.
U113	2nd Temperature Setpoint	41 - 104 °F 5.0 - 40.0 °C	73 °F 23.0 °C	Allows for a dry contact through the customer input connections. When a customer input connection is set for 2nd temperature setpoint and that input is triggered, then the value set in this parameter sets the active temperature setpoint the unit will maintain. If the unit is configured for Decoupled Mode then this setpoint will only affect the temperature control setpoint and will not affect the fan control setpoint.
U114	Supply Temp Limit Setpoint	41 - 81 °F 5.0 - 27.0 °C	41 °F 5.0 °C	Selects the minimum discharge air temperature. When the actual sensor reading approaches this parameter, the cooling capacity will be limited to avoid going below the Supply Limit Temperature value. This parameter must be enabled in the Service Menu/Setpoints menu prior to setting a supply limit setpoint.
U116	BMS Backup Temp Setpoint	41 - 104 °F 5.0 - 40.0 °C	73 °F 23.0 °C	Selects a temperature setpoint that will be activated in the event of a BMS time out or a customer input signal. The BMS timer and/or the customer input must be configured for this parameter to activate. If the unit is operating in Decoupled mode, then this setpoint will only affect the temperature control setpoint; it will not affect the fan control setpoint.
U117	BMS Backup Fan Setpoint	41 - 104 °F 5.0 - 40.0 °C	73 °F 23.0 °C	Selects a temperature setpoint when the backup fans will be activated in the event of a BMS time out or a customer input signal. The BMS timer and/or customer input must be configured in order for this parameter to activate. If the unit is operating in Decoupled mode, then this setpoint will only affect the temperature control setpoint; it will not affect the fan control setpoint.
	BMS Backup Fan Speed	0 - 100 %	100%	
U119	Return Compensation Setpoint	41 - 104 °F 5.0 - 40.0 °C	73 °F 23.0 °C	Allows the return air sensor to be used even when in Supply or Remote temperature control mode. Return Compensation modifies the temperature setpoint to ensure that the return air temperature is kept above a specific temperature. If the return compensation value is set to 80 °F and the actual return temperature falls to 75 °F, then the controlling temperature setpoint will be increased and will reflect in the "Control Temp Act" parameter.

Table B.2 Service Menu Setpoints by Line ID

Line ID	Parameter Name	Range	Default Setting	Description
S102	Temperature Control Sensor	Supply Sensor Return Sensor Remote Sensor	Return Sensor	Selects which sensor will be controlling/influencing the cooling capacity. Cooling Capacity is either the Chilled Water Valve, Compressor, FreeCooling Valve, or Air Economizer. Unloading type compressors can be set to any sensor type, however fixed style compressors can only be set to Return or Remote control sensor.
S103	Temperature Setpoint	41 - 104 °F 5.0 - 40.0 °C	73 °F 23.0 °C	Selects a temperature that the cooling unit will maintain by applying cooling and/or reheats. The temperature setpoint value that has been set by the User to control the temperature.
	Temperature Setpoint Actual	32 - 113 °F 0.0 - 45.0 °C	73 °F 23.0 °C	The temperature setpoint actual value is a read-only value that indicates if another routine, such as supply compensation has internally modified the Temperature controlling value. If compensation has not been activated, the ACT and SET will always match.
S104	Temperature Control Type	Proportional PI Adaptive PID Intelligent	PI	Sets the type of control to be followed: Proportional, PI, Adaptive PID (auto-tuning), Intelligent
S105	Temperature User Low Limit	41 - 104 °F 5.0 - 40.0 °C	41 °F 5.0 °C	Defines the temperature range below setpoint; temperature setpoint cannot be adjusted below this value. If the setpoint value has been adjusted lower than this setting, then the setpoint will automatically default back to its previous setting.
	Temperature User High Limit	41 - 104 °F 5.0 - 40.0 °C	104 °F 40.0 °C	Defines the temperature range above setpoint; temperature setpoint cannot be adjusted above this value. If the setpoint value has been set higher than this setting, then the setpoint will automatically default back to its previous setting.
S106	Temperature Proportional Band	4 - 200 °F 2.2 - 111.0 K	12 °F 6.7 K	Adjusts the activation points of compressors/chilled water valves or rate of changed based on the actual sensor values deviation from setpoint. The smaller this number, the faster the compressors/chilled water valves will increase capacity. Too small of a number may cause the unit to short cycle compressors or excessively reposition the valve.
	Temperature Integral Time	0.0 - 15.0 min	5.0 min	Adjusts the capacity of the units based on time away from setpoint so that accurate temperature control can be maintained. The proportional and integral time settings work together to maintain setpoint. Large p-band and small integral time is typical when controlling to supply air.
S107	Temperature Derivative Time	0 - 900 sec	0 sec	
S108	AutoSet Enable	No Yes	Yes	Sets the temperature and humidity proportional bands automatically based on the type of unit when this parameter is set to YES and if teamwork modes are selected. To change the proportional bands, this parameter must be set to NO. If supply or remote sensors are used, then this value is always set to NO.
S109	Temperature Deadband	0 - 36 °F 0 - 20.0 K	2 °F 1.1 K	Avoids overshooting of the setpoint and cycling between cooling and reheats. The value entered in this field will be split in half by the temperature setpoint.
S110	Supply Limit Enabled	No Yes	No	Chilled water units may be set up with the supply air sensor to maintain a minimum air temperature under the raised floor to help prevent condensation. In order to avoid supply temperatures that are too low, the Supply Limit can influence the opening of three-point or analog actuators or the output of analog values. The control compares the deviation from the return air setpoint & the supply limit setpoint, and calculates the output to the actuator from the smaller deviation.
	Supply Limit Setpoint	41 - 81 °F 5.0 - 27.0 °C	41 °F 5.0 °C	
S111	Heater Deadband	0 - 36 °F	0 °F	Changes the amount of deviation below the temperature setpoint that the heaters will cycle ON and OFF. This value is added to the heating side of the normal temperature deadband.

Table B.2 Service Menu Setpoints by Line ID (continued)

Line ID	Parameter Name	Range	Default Setting	Description
		0 - 20.0 K	0.0 K	
S113	Enable Temperature Compensation	No Return Supply Ret+Sup	No	Temperature compensation allows for a second or even a third sensor to be used that will influence the units cooling or heating. Return compensation can be used when the supply or remote sensors are being used for control. Then the return sensor is then monitored to maintain a minimum return temperature. Supply compensation can be used only when Optimized Aisle (TW3) is enabled. The supply sensor will not only be used for controlling cooling capacity but will also monitor the cold aisle temperature to ensure that the cold aisle temperature setpoint is met.
S114	Return Compensation Setpoint	41 - 104 F 5.0 - 40.0 C	73 F 23.0 C	The temperature setpoint where compensation begins to operate by increasing the supply air setpoint.
S115	Return Compensation Band	0 - 18 F 0.0 - 10.0 K	0 F 0.0 K	The return compensation band/value will determine how quickly the cooling capacity is adjusted as the return temperature drops below the return compensation setpoint.
	Return Compensation Value	0 - 18 F 0.0 - 10.0 K	0 F 0.0 K	
S116	Supply Compensation Value	0 - 18 F 0.0 - 10.0 K	0 F 0.0 K	The Supply Compensation value determines how much the supply temperature setpoint will be reduced when the units fan speed is at 100% and the cold aisle is not able to maintain temperature setpoint. Any modifications to the supply temperature setpoint will be shown at the temperature setpoint on parameter S103 as the actual active control point.
S118	Compressor Capacity Filter at 0 %	0.01 - 99.99 %/s	0.60 %/s	Controls the rate of change during compressor load changes to avoid overshoots. The filter value depends on the current control deviation from setpoint. On the setpoints (0% call for cooling), it's typically set lower (slow).
	Compressor Capacity Filter at 100%	0.01 - 99.99 %/s	4.00 %/s	At the end of the proportional band (100% call for cooling) it's typically set higher (faster).
S119	Capacity Transition Filter	0.01 - 99.99 %/s	4.00 %/s	This parameter should only be adjusted by a factory-service trained technician. The transition capacity filter controls how quickly the capacity changes between different modes of operation. This filter helps with the transition to avoid overshoot.
S120	CW Capacity Filter @ 0%	0.01 - 99.99 %/s	0.10 %/s	The CW capacity filter controls the rate of change during a valve position adjustment to avoid overshoots. The filter value depends on the current control deviation from setpoint. On the setpoint (0% call for cooling), its typically set lower (slower)
S121	CW Capacity Filter at 100%	0.01 - 99.99 %/s	0.60 %/s	At the end of the p-band (100% call for cooling) its typically set higher (faster)
	BMS Backup Temp Setpoint	41 - 104 F 5.0 - 40.0 C	73 F 23.0 C	Selects a temperature setpoint that will be activated in the event of a BMS time out. The BMS timer must be configured for this parameter to be active.
S122	2nd Temperature Setpoint	41 - 104 F 5.0 - 40.0 C	73 F 23.0 C	Selects a temperature setpoint that will be activated in the event of a customer input signal configured as the second setpoint. The customer input must be configured for the parameter to activate.

Table B.2 Service Menu Setpoints by Line ID (continued)

Line ID	Parameter Name	Range	Default Setting	Description
S124	Humidity Control Sensor	Remote Sensor Return Sensor	Return Sensor	Defines which humidity sensor the humidity setpoint is compared with. The return sensor is equipped with a Temp/Hum sensor and can calculate the dew point based on the iCOM internal lookup table. If a sensor other than the return sensor is selected, the Liebert iCOM will calculate the corresponding RH% based on that sensors actual temperature.
S125	Dew Point Setpoint	41 - 65 °F 5.0 - 18.3 °C	48 °F 8.9 °C	Selects a humidity level that the cooling unit will maintain by removing or adding moisture to the air. The humidity setpoint will either be set in percent RH or as a Dew Point value depending on what the humidity control type is set for.
	Humidity Setpoint	20 - 80 %	0.5	
S126	Humidity Control Type	Relative Compensated Predictive Dew Point	Predictive	Selects the humidity control calculation. Setting this parameter to Relative (%RH) will control the humidity without considering any temperature deviations. Predictive and Absolute control consider the temperature deviation from temperature setpoint so that a constant level of moisture is kept in the area based on the humidity sensor reading and the temperature deviation from setpoint. Compensated is recalculated with the actual deviation from temperature setpoint. 1 degree Celsius is equal to 3 %RH, indirect proportional. If temperature increases, the humidity setpoint is decreased and vice versa.
	Humidity Control Mode	Supply Return	Return	
S127	Dew Point Proportional Band	2 - 18 °F 1.1 - 10.0 K	8 °F 4.4 K	Adjusts the activation points of the humidifier and compressors based on the actual sensor values deviation from setpoint. The smaller this number, the faster the compressors and humidifier will increase capacity. Too small of a number may cause the unit to short cycle or overshoot setpoint.
	Humidity Proportional Band	1 - 20%	0.2	
S128	Humidity Integration Time	0.0 - 25.0 min	0.0 min	Adjusts the capacity of the unit based on a time away from setpoint so that accurate humidity control can be maintained. If the integration time is set to 0, the humidity control operates as a proportional only control. When integration time is set, the control mode changes to PI control
S129	Humidity Deadband	0 - 18 °F 0.0 - 10.0 K	4 °F 2.2 K	Prevents overshooting of the setpoint and cycling between humidification and dehumidification. The value entered in this field will be split in half by the temperature setpoint.
S130	Dehum Supply Temperature Setpoint	41 - 104 °F 5.0 - 40.0 °C	54 °F 12.2 °C	Allows for a target temperature setpoint to be activated when a call for dehumidification is enabled instead of the traditional method of over cooling the space by increasing cooling to 100% and lowering fan speed if equipped. Must be in supply air control mode. When a call for dehumidification is active, the supply or remote sensor setpoint will be lowered to this parameter. This parameter should be set below the accepted dew point threshold of your space. Used only when supply dehumidification is enabled.
	Actual Dehum Temperature Setpoint	41 - 104 °F 5.0 - 40.0 °C	50 °F 10.0 °C	
S131	Dehum Setpoint Adjustment	0 - 18 °F 0.0 - 10.0 K	9 °F 5.0 K	Sets the amount of that the Dehum Temp Setpoint is adjusted once the reheats activate. For example, if the unit is equipped with a reheat device, this parameter will increase the dehumidification temperature as the call for reheats are increased until the reheat call is at 100%. When the reheats are at 100%, the full Dehum Setpoint Adjustment will be applied.
	Dehum Setpoint Filter	0.01 - 0.10 K/s	0.02 K/s	
S132	Dehum Reheat/LL Sensor	Supply Sensor Remote Sensor Return Sensor	Return Sensor	Sets the sensor and temperature start point that the reheat will be deactivated and dehumidification will be stopped due to over cooling the space in a call for dehumidification.
	Dehum Reheat/LL	41 - 104 °F	71 °F	

Table B.2 Service Menu Setpoints by Line ID (continued)

Line ID	Parameter Name	Range	Default Setting	Description
	Setpoint	5.0 - 40.0 °C	21.7 °C	
S133	Dehum/Reheat Low Limit 1 Temp Hysteresis	-30.0 °F - -2.0°F -16.7K - -1.1K	-5 °F -2.5 K	Dehum/Reheat Low Limit 1
	Dehum/Reheat Low Limit 2 Temp Hysteresis	-30.0 °F - -2.0°F -16.7K - -1.1K	-7 °F -3.9 K	Dehum/Reheat Low Limit 2
S13A	Dehum Reheat Proportional Band	2 - 54 °F 2.0 - 30.0 K	14 °F 7.8 K	Sets the reheat proportional band for reheat operation independently of the temperature proportional band. This parameter can be used to activate the reheats at different points below the temperature setpoint.
S13B	Estimated Aisle Temp	41 - 104 °F 5.0 - 40.0 °C	75 °F 23.9 °C	Sets an estimated cold aisle temperature when humidity control sensor is set to remote and no remote temperature sensors are installed at the unit. This estimated temperature will be used to determine the humidity versus using an actual temperature in the cold aisle that may fluctuate during modes of dehumidification or load changes of the IT equipment. This provides a stable control point to reference the actual measured dew point from the return sensor.
S135	DT1 (Room/Outdoor) Type	0 = Disabled 1 = Contact 2 = EFC 3 = Temp 4 = Set	Temp	Sets the activation point of the ambient dry bulb outdoor temperature as it relates to either an indoor actual temperature or temperature setpoint.
S136	DT1 (Room/Outdoor) Value	2 - 72 °F 1.0 - 40.0 K	5 °F 3.0 K	Field adjustable setpoint or temperature.
S137	DT2 (Room/FC Fluid) Type	Disabled Contact Temp Set	Disabled	Determines the method to activate the water circuit on Dual-Cool and Free- Cool units. It may be set to CONTACT, TEMP or SET CONTACT uses a dry contact to activate the free cooling circuit. TEMP uses a sensor reading that can be compared to the return temp to see whether free cooling is possible. SET compares the temperature set to the free cooling sensor to determine free cooling availability.
S138	DT2 (Room/FC Fluid) Value	0 - 36 °F 0.0 - 20.0 K	12 °F 6.7K	Sets the delta T between the actual temperature and fluid temperature that must be met before free cooling will occur.
S139	Minimum Chilled Water Temp Enable	No Yes	Disabled	Enables the temperature at which free cooling can operate independently without assistance of the compressor circuit(s).
S140	Minimum Chilled Water Temp Value	32 - 68 °F 0.0 - 20.0 °C	45 °F 7.0 °C	Sets the water temperature at which 100% free cooling can be provided to handle the full room load. When the fluid temperature is below this setting, then the compressors will no longer turn ON until the water temperature is above the minimum chilled water temperature.
S141	Lockout FC at Fluid Below	6 - 50 °F -15.0 - +10.0°C	32 °F 0.0 °C	Prevents frost from building up on the free cooling pipes when the outdoor ambient temperature is extremely low by turning OFF the free cooling circuit when the water temperature is too low.

Table B.2 Service Menu Setpoints by Line ID (continued)

Line ID	Parameter Name	Range	Default Setting	Description
S146	Fan Control Sensor	Supply Sensor Remote Sensor Return Sensor Manual	Return Sensor	Controls the fan speed for modulation. If MANUAL is selected, then the fan speed can be controlled from the local display or through a building management system.
S147	Fan Setpoint	41 - 104 °F 5.0 - 40.0 °C	73 °F 22.8 °C	Activated when a temperature sensor is being used to control the fan speed. If the same sensor is used for temperature control and fan speed control, then this value will reflect the same setpoint as the temperature control setpoint. Manual mode uses fan speed STD for control.
S148	Fan Temperature Control Type	Proportional PI Adaptive PID	PI	Sets the type of control the unit will use to control fan speed. PI control gain is set in the Temp Prop/Integral parameter. PI control will operate the fan speed so that the actual temperature of the fan control sensor is equal to the fan temp setpoint. If PROPORTIONAL only is selected, the fan will change ONLY based on the deviation from setpoint which will allow the actual temp to settle higher than setpoint.
149	Fan Temperature Control Prop Band	4 - 200 °F 2.0 - 111.0 K	36 °F 20.0 K	Adjusts the fan speed rate of change based on the actual sensor values deviation from setpoint. The smaller this number, the faster the fans will increase speed. Too small of a number may cause the fans increase/decrease to overshoot setpoint
	Fan Temperature Control Integration Time	0.0 - 15.0 min	1.0 min	Adjusts the fans of the unit based on time away from setpoint so that accurate temperature control can be maintained. The proportional and integral work together to maintain setpoint. Large p-band with small integral time is a typical way to achieve stable control.
S150	Fan CFF Hysteresis	0 - 20 %	0.02	Modifies the reaction of the fan speed when fan speed is being dictated by the Call for Cooling. Adding the Hysteresis may result in a lagged response to changes in fan speed.
	Fan Deadband	0 - 36 °F 0 - 20.0 K	1 °F 0.6 K	Avoids overshooting of the setpoint. The value entered in this field will be split in half by the fan speed setpoint
S151	Airflow Calibration	3.0 - 10.0 V	10.0 V	Allows the front display to be scaled to show the actual percentage of airflow independent of the voltage operating the fan speed. This value cannot be set above/below the Analog Output High/Low Limit for the fan set in the Advanced Menu. This also includes the service menu fan speed parameters.
S152	Fanspeed VSD Setpoint Minimum	0 - 100 %	0.7	Sets the range for the variable fans. Min sets the minimum speed that the fan will operate at. Fan speed is modulated between MIN and STD based on which sensor is set as the controlling sensor, setpoint and the PI settings. If the controlling sensor is set to manual, then the STD setting will control the current fan speed. This parameter is also adjustable through the BMS.
	Fanspeed VSD Setpoint Standard	0 - 100 %	1	
S153	Fanspeed VSD Setpoint Dehum	0 - 100 %	70%	Sets the fan speed when a call for dehumidification is active. This allows the units fan speed to be ramped lower to help with any over cooling due to the dehumidification process. This also allows the coil to remove additional moisture even faster
	Fanspeed VSD Setpoint No Power	0 - 100 %	100%	
S154	Allow Fan Modulation on Compressors	No Yes	Yes	Provides the option to set the fan to fixed speed if unit is equipped with compressors. Once this parameter is set at the local display, it must be removed at the local display to re-engage fan speed control.
S155	High Return Limit Enable	Disabled Local Team	No	Sets a control point that will increase the fan speed if the return temperature exceeds the limit set in the High Return Temperature Limit parameter. If set to

Table B.2 Service Menu Setpoints by Line ID (continued)

Line ID	Parameter Name	Range	Default Setting	Description
				DISABLED, no limit will be applied to the return air temperature. If set to LOCAL, then only the local units return temperature will be monitored for applying the limit. If set to TEAM, then the highest networked unit return temperature will activate the limit on all connected units.
S15A	High Return Temperature Limit	41 - 104 °F 5.0 - 40.0 °C	85 °F 29.4 °C	Sets the temperature limit that will increase the fan speed to decrease the return temperature. Some compressors may require this limit to prevent extremely high temperatures that could potentially cause degradation of the compressor oil, that could decrease the overall compressor life expectancy.
S15B	Return Limit Proportional Band	0 - 36 °F 0.2 - 20.0 K	20 °F 11.1 K	Sets the rate of fan speed increase as the actual return temperature approaches the limit set in the High Return Temperature limit parameter.
S157	Fan Start up Time	0 - 600 sec	3 sec	Determines the speed of the fan at system start up. The fan will operate at the set speed (%) until the set time has elapsed. At this point the fan will assume normal operation.
	Fan Start up Speed	0 - 100 %	100%	
S158	Fanspeed Filter at 0%	0.01 - 99.99 %/s	0.20 %/s	This parameter should only be adjusted by factory service trained technician. Fan Cap Filter at 0/100% controls the rate of change during fan speed changes to avoid overshoots. The filter value depends on the current control deviation from setpoint. On the setpoint (at 0%), its typically set lower (slower). At the end of the p-band (at 100%) its typically set higher (faster). The value is given as a percentage of control output per second change. This parameter sets the rate of changed based on where actual temperature is when compared to setpoint.
S159	Fanspeed Filter @ 100%	0.01 - 99.99 %/s	1.00 %/s	This parameter should only be adjusted by factory service trained technician. The transition fan speed filter controls how quickly the fan speed changes between different modes of operation. This filter helps with the transition to avoid overshoots.
	Fanspeed Transition Filter	0.50 - 99.99 %/s	1.00 %/s	
S160	Fanspeed Reposition Mode	Decel Both	Decel	This parameter should only be adjusted by factory service trained technician. The fan speed reposition mode/delay is a one time delay as the fan speed is requested to change direction. This delay will be applied only when the fan speed is commanded from an increasing to decreasing state or decreasing to increasing state. This allows the fan to hold its current position while the temperature stabilizes.
	Fanspeed Reposition Delay	0 - 300 sec	0 sec	
S161	Max Deceleration Rate	0.01 - 99.99 %/s	0.10 %/s	This parameter should only be adjusted by the factory service trained technician. Only slows the decreasing of the variable fan speed. The control will use the slower of this parameter and the fan speed filter.
S162	BMS Backup Fan Setpoint	41 - 104 °F 5.0 - 40.0 °C	73 °F 23.0 °C	Selects a fan speed setpoint that will be activated in the event of a BMS Timeout. The BMS timer must be configured for this parameter to activate.
	BMS Backup Fanspeed	0 - 100 %	1	
S163	BMS Backup Fan Operation	Disabled BMS Backup Spd Coupled BMS Backup Set	Disabled	Sets the default operation of the fan speed control when a BMS Timeout occurs. Default is disabled which will keep the fan speed at the last value before the disconnect occurred. STD speed will ramp the fan to the STD speed setting. This will drive the fan speed to its maximum speed. The control will use the slower value. COUPLED will set the fan speed to follow the cooling capacity. BACKUP SET will use the BMS Backup Setpoint to drive fan speed.
S164	Allow BMS to change Fanspeed	No Yes	Yes	

Table B.2 Service Menu Setpoints by Line ID (continued)

Line ID	Parameter Name	Range	Default Setting	Description
				Enables or disables BMS fan speed control. When this parameter is disabled, the BMS will not have write capability to this point.
S165	BMS is connected to	Velocity Ana In 1 Ana In 2 Ana In 3 Ana In 4	Velocity	If the BMS is connected to Analog Input (1-4), it is used for manually writing to & controlling the unit fan speed using a low-voltage control signal. If the BMS is set to 'Velocity' (V3 or V4), it is used for manually writing to & controlling the unit fan speed via the Velocity protocol.
	BMS Analog Input Signal Type	0-5V 0-10V 4-20mA None	None	
	BMS Analog Input current value	0 - 100%	100%	
S166	High Temp Limit Approach	Disabled Supply Return	Return	Sets the sensor to be used to increase the fan speed value above the fan speed setpoint STD to the value set in the Analog Output high limit.
S16A	High Temp Limit Approach at	0 °F / +10 °F 0 K / +5.5 K	2 °F 1.1 K	Sets the temperature differential below the high supply and high return temperature limit where the fan speed would increase from fan speed setpoint STD to fan speed MAX.
S16B	FC / AirEco Ramp Up w/ CFC	0 = No 1 = Yes	0 (No)	Sets the selection to decouple the fan output from the call for cooling.
S168	Fan Back Draft Control	Disabled Enabled	Disabled	Enables/disables Fan Back Draft Control. This feature allows EC Fans (only) to operate at very low speeds to prevent airflow from cycling through the unit due to a high under floor static pressure than above the floor static pressure. VFDs cannot be used with this feature due to motor and/or bearing degradation that may occur at the low fan speeds required to support this feature.
S169	VSD Setpoint Back Draft	0.1 - 5.1 V	1.5 V	The variable speed device setpoint is set as a voltage reference. The lower the voltage, the slower the fans will spin. This parameter is set based on the application. Higher under floor static pressure may require a higher setting to prevent airflow through the unit.
S171	Not Selectable Zone 1 Low	0.0 - 5.0 V	3.5 V	The not selectable zone 1 and 2 are zones that the EC fans cannot operate within due to vibration harmonics that the fans may introduce to the unit. These parameters will be set from the factory based on model type and should not need adjusted in the field.
S172	Not Selectable Zone 2 Low	0.0 - 5.0 V	0 V	The not selectable zone 1 and 2 are zones that the EC fans cannot operate within due to vibration harmonics that the fans may introduce to the unit. These parameters will be set from the factory based on model type and should not need adjusted in the field.
	Not Selectable Zone 2 High	0.0 - 5.0 V	0 V	
S173	Stop BDR when System is OFF	No Yes	No	The above is true when S173 Stop BDR when System is OFF is set to YES. If set to NO, the BDR mode will not be interrupted, unless BDR is disabled or the unit is restarted.
S175	Display Off and BDR	Off BackDraft	Off	When the back draft damper is enabled, different modes can activate this feature. Remote Off, Display Off, BMS Off, and Local Off can all be set to activate the back draft damper operation. This is done by pressing the ON/OFF key at the unit to put the unit in a Display Off condition

Table B.2 Service Menu Setpoints by Line ID (continued)

Line ID	Parameter Name	Range	Default Setting	Description
S176	BMS Off and BDR	Off BackDraft	Off	When the back draft damper is enabled, different modes can activate this feature. Remote Off, Display Off, BMS Off, and Local Off can all be set to activate the back draft damper operation. This is done by sending a remote OFF signal from BMS to the unit to be remotely OFF.
S177	LOC Off and BDR	Off BackDraft	Off	When the back draft damper is enabled, different modes can activate this feature. Remote Off, Display Off, BMS Off, and Local Off can all be set to activate the back draft damper operation. This is done by sending local OFF signal to the unit by pressing the ON/OFF key.
S179	SCR Control Type	None Tight Standard	None	Sets the control type for the SCR reheats. If set to Standard, then the reheats will modulate when the temperature is below setpoint based on the control settings. If set to Tight, then one compressor will be locked on and the reheats will modulate to offset the cooling capacity.
S180	Start 1st Compressor at	-100 / +100 %	0%	Sets activation point of the first compressor. This parameter can be used when set to Tight control with SCR.
S181	Stop 1st Compressor at	-200 / +50 %	-200 %	Sets the deactivation point of the first compressor. This parameter can be used when set to Tight control with SCR.
S182	1st Compressor stop delay	0 - 30 min	20 min	Sets the delay when the stop compressor setpoint for the first compressor is met.
S183	Start 2nd Compressor at	-100 / +100 %	100%	Sets activation point of the second compressor. This parameter can be used when set to Tight control with SCR.
S184	Stop 2nd Compressor ats	-200 / +50 %	0%	Sets the deactivation point of the second compressor. This parameter can be used when set to Tight control with SCR.
S185	2nd Compressor stop delay	0 - 30 min	0 min	Sets the delay when the stop compressor setpoint for the second compressor is met.
S186	Cycle Time	1.0 - 200.0 sec	1.0 sec	Set at the factory and should be changed only by an authorized Vertiv/Liebert technician.
S187	SCR Factor	1.0 - 10.0	1	Set at the factory and should be changed only by an authorized Vertiv/Liebert technician.
S188	Actual SCR request	0 - 100 %	0%	Displays the actual SCR reheat being requested.
S190	Static Pressure Fan Control	Disabled Limit Control	Disabled	Enables/disables the use of static pressure control for fan modulation.
S191	Static Pressure Setpoint inWC	0.010 - 1.003 inWC	0.020 inWC	Sets the static pressure setpoint to be used by the control to modulate the fan control.
	Static Pressure Setpoint Pa	2 - 250 Pa	5 Pa	
S192	Static Pressure Deadband in WC	0.010 - 1.003 inWC	0.020 inWC	Sets the static pressure deadband.
	Static Pressure Deadband Pa	2 - 250 Pa	5 Pa	

Table B.2 Service Menu Setpoints by Line ID (continued)

Line ID	Parameter Name	Range	Default Setting	Description
S193	SP Pause Time at Deadband minimum	0 (Disabled) - 180 sec	30 sec	Sets the minimum and maximum pause times when the static pressure crosses into the deadband border. The fan speed will stop increasing or decreasing based on the time set in these parameters.
	SP Pause time at Deadband maximum	2 - 180 sec	60 sec%	
S194	SP Pulse Time inside Deadband	2 - 15 sec	3 sec	Sets the pulse time that the speed filter will be performed to the fan analog output.
S195	Static Pressure Prop Band inWC	0.010 - 1.003 inWC	0.020 inWC	Sets the proportional band for which the fan speed modulation output calculation is based upon in relation to the difference between the pressure reading the "SP Setpoint".
	Static Pressure Prop Band Pa	2 - 250 Pa	5 Pa	
S196	SP During Dehum	Disabled Enabled	Disabled	Sets the use of static pressure control if dehumidification becomes active. It set to Disabled then the static pressure routines will become inactive and the fan will be allowed to ramp to the dehumidification speed set in "Fanspeed Dehum/No Power". If set to Enabled, then the static pressure routines shall remain active during the call for dehumidification.
S197	Static Pressure Teamwork Mode	Average Minimum	Average	There are modes available for static pressure teamwork functionality: Average & Minimum. When selecting Average Mode, the average of the lowest static pressure sensor readings in the system will be average to generate a shared static pressure value for all units in the team. The number of static pressure sensors to be averaged is set in line S198 SP Sensors in Avg for TW. When this line is set to a value lower than the number of units in the team, the lowest static pressure readings will be averaged.
S198	SP Sensors in Avg for TW	1 - 32	2	Sets the number of sensors used when averaging sensors in the teamwork.
S199	Operation on Sensor Failure	SP Off Freeze Speed	SP Off	This parameter determines what action to take if the static pressure sensor fails (non-teamwork). If SP OFF is selected, then the control will use S146 Fan Control Sensor to control the fan when the sensor is lost. If Freeze Speed is selected, then the control will keep the fan speed in its last known position. Situations that need to override the fan speed such as Freeze Protection can still change the fan speed.
S1A1	Static Pressure Upper Range inWC	0.010 - 1.003 inWC	0.030 inWC	The control calculates the Upper Range by using S191 "SP Setpoint" and S192 "SP Deadband", the results on lines show both values, inWC and Pa.
	Static Pressure Upper Range Pa	2.5 - 250.0 Pa	7.5 Pa	
S1A2	Static Pressure Lower Range inWC	0.000 - 0.993 inWC	0.010 inWC	The control calculates the Lower Range by using S191 "SP Setpoint" and S192 "SP Deadband", the results on lines show both values, inWC and Pa.
	Static Pressure Lower Range Pa	0.0 - 247.5 Pa	2.5 Pa	
S1A4	Enable Static Pressure Control Override	None Remote Sensor Return Sensor	None	
S1A5	SP Requested Speed up to	41 - 104 °F	86 °F	
		5.0 - 40.0 °C	30.0 °C	

Table B.2 Service Menu Setpoints by Line ID (continued)

Line ID	Parameter Name	Range	Default Setting	Description
S1A6	STD Speed at	41 - 104 °F 5.0 - 40.0 °C	95 °F 35.0 °C	
S1A7	Override Integration Time	0.0 - 15.0 min	0.0 min	
S1A8	Control Slew Rate Filter	0.50 - 99.99 %/s	1.00 %/s	
S1A9	Current Override Temperature	°F °C	invalid	
S1B1	Current Override Value	0 - 100 %	0%	
S1B9	Create SuperSaver Signal	0 = No 1 = Local 2 = U2U Group AVG 3 = U2U Group MAX 4 = U2U Group MIN	0 (No)	
S1C1	Deadband Low Value	5 - 95 %	20%	
S1C2	Deadband High Value	10 - 100 %	90%	
S1C3	Update SuperSaver Signal every	30 - 300 sec	120 sec	
S1C4	Update SuperSaver Signal by	1 - 10 %	1%	
S1C5	SuperSaver Max Limit	0 - 100 %	100%	
S1C6	Current SuperSaver Request	0 - 100 %	0%	
	Current SuperSaver Signal	0 - 100 %	0%	
S1C7	U2U Aggregated Signal	0 - 100 %	0%	
XDU.006	Calibration Leaving Air Temperature	+/-18°F	0°F	Calibrate Supply Air Leaving Temperature sensor reading
XDU.008	Calibration Entering Fluid	+/-18°F	0°F	Calibrate Entering Fluid Temperature sensor reading

Table B.2 Service Menu Setpoints by Line ID (continued)

Line ID	Parameter Name	Range	Default Setting	Description
	Temperature			
XDU.007	Calibration Leaving Fluid Temperature	+/-18°F	0°F	Calibrate Leaving Fluid Temperature sensor reading
XDU.009	Fluid Flow Rate at Full Scale (20mA)	10 - 1000 l/m	115 l/m	Fluid Flow Rate @ Full Scale (20mA)
XDU.010	Fluid Flow Rate Setpoint	5.0 - 1000.0 l/m	50.0 l/m	display readout showing current Fluid Flow Rate
XDU.011	Fluid Pump Initial Speed	30 - 100%	50 %	Fluid Pump Initial Speed %
XDU.012	Fluid Flow Proportional Band	1.0 - 1000 l/m	20.0 l/m	Fluid Flow Proportional Band
XDU.013	Fluid Flow Deadband	0.0 - 100.0 l/m	10.0 l/m	Fluid Flow Deadband
XDU.014	Fluid Flow Integration Time	0 - 300 sec	60 sec	Fluid Flow Integration Time
XDU.018	Pump Transition Duration	0 - 30 sec	15 sec	overlap timer for when pumps are rotating from one another
XDU.021	Pump Sequence	0 = Auto 1 = Pump 1 2 = Pump 2	(0) Auto	Specifies which is the lead pump. If configured for auto, pumps will rotate for equal run time purposes based off a set schedule
XDU.027	Pump Rotation Frequency	0 - 30 days	7 days	Allows end user to define how often pumps should rotate
XDU.035	Flow Switch Time Delay	1 - 9999 sec	20 sec	
XDU.052	Minimum Fluid Flow Volume	1.0 - 1000.0 l/m	5.0 l/m	Allows end user to specify minimum Fluid Flow
XDU.053	Perform Pump Rotation	0 = No 1 = Yes	(0) No	Allows end user to force a pump rotation

B.3 Line IDs for Alarm Setting Parameters

Table B.3 User Menu Alarm Settings by Line ID

Line ID	Parameter Name	Range	Default Setting	Description
U202	Return Sensor Alarms	Disabled Enabled	Enabled	Enables or disables the return sensor alarms. When enabled, the return temperature and humidity values will be compared to a high & low setting.
U203	High Return Temperature	34 - 210°F 1.0 - 99.0 °C	100 °F	Allows a user to adjust the point at which the actual return temperature activates a High Temperature Alarm.
U204	Low Return Temperature	34 - 210°F	65 °F	Allows a user to adjust the point at which the actual return temperature activates the Low Temperature Alarm.

Table B.3 User Menu Alarm Settings by Line ID (continued)

Line ID	Parameter Name	Range	Default Setting	Description
		1.0 - 99.0 °C		
U205	High Return Humidity	1.0 - 99.0 %	65.0%	Allows a user to adjust the point at which the actual return humidity activates the High Humidity Alarm.
U206	Low Return Humidity	1.0 - 99.0 %	35.0%	Allows a user to adjust the point at which the actual return humidity activates the Low Humidity Alarm.
U207	Sensor A Alarms	Disabled Enabled	Disabled	Enables or disables the alarms for reference Sensor A. When enabled, the Sensor A temperature and humidity values will be compared to a high and low setting.
U208	High Temperature Sensor A	34 - 210°F 1.0 - 99.0 °C	90 °F	Allows a user to adjust the point at which the actual Sensor A temperature activates a High Temperature Alarm.
U209	Low Temperature Sensor A	34 - 210°F 1.0 - 99.0 °C	55 °F	Allows a user to adjust the point at which the actual Sensor A temperature activates a Low Temperature Alarm.
U210	High Humidity Sensor A	1.0 - 99.0 %	70.0%	Allows a user to adjust the point at which the actual Sensor A humidity activates a High Humidity Alarm.
U211	Low Humidity Sensor	1.0 - 99.0 %	30.0%	Allows a user to adjust the point at which the actual Sensor A humidity activates a Low Humidity Alarm.
U213	Supply Sensor Alarms	Disabled Enabled	Disabled	Enables or disables the supply sensor alarms. When enabled, the supply temperature value will be compared to a high and low setting.
U214	High Supply Temperature	34 - 210°F 1.0 - 99.0 °C	75 °F	Sets the temperature at which the High Supply Temperature Alarm is activated.
U215	Low Supply Temperature	34 - 210°F 1.0 - 99.0 °C	50 °F	Sets the temperature at which the Low Supply Temperature Alarm is activated.
U219	Remote Sensor Alarms	0 = Disabled 1 = Com Set 2 = Sep Set	Disabled	Enables or disables the remote sensor alarms. When enabled, the remote temperature values will be compared to a high and low setting.
U220	High Remote Temperature	34 - 210°F 1.0 - 99.0 °C	90 °F	Enables or disables remote sensor temperature alarms. When enabled, the high and low remote temperature alarm will allow a user to adjust the point at which the actual remote temperature activates a High/Low temperature alarm. This parameter is used when common alarm points will be shared by all sensors. Otherwise, the remote sensors can be set individually.
	Low Remote Temperature	34 - 210°F 1.0 - 99.0 °C	55 °F	
U224- U233	High Remote 01-10	34 - 210°F 1.0 - 99.0 °C	90 °F	Sets the high and low remote temperature sensor alarm points individually for each sensor when the parameter separate thresholds is set to disabled
	Low Remote 01-10	34 - 210°F	55 °F	

Table B.3 User Menu Alarm Settings by Line ID (continued)

Line ID	Parameter Name	Range	Default Setting	Description
		1.0 - 99.0 °C		
U235	Static Pressure Messages	Disabled Enabled	Disabled	Enables or disables static pressure messages.
U236	High Static Pressure (inWC)	0.010 - 1.405 inWC	1.284 inWC	Sets the pressure at which the High Static Pressure Alarm is activated (inWC, Pa)
	High Static Pressure (Pa)	2 - 350 Pa	320 Pa	
U237	Low Static Pressure (inWC)	0.000 - 1.395 inWC	0.000 inWC	Sets the pressure at which the Low Static Pressure Alarm is activated (inWC, Pa)
	Low Static Pressure (Pa)	0 - 348 Pa	0 Pa	
U238	SP Messages During Unit Off	No Yes	No	Enables or disables Static Pressure messages when the unit is OFF
U239	SP Messages on Fan Adjust	No Yes	No	Enables or disables the static pressure messages when the fan has been adjusted due to special events. These events include an adjustment for heating, humidification, dehumidification, motor overload / EC fan fault or loss of airflow.
U240	SP Transducer High Range (inWC)	0.000 - 1.405 inWC	1.284 inWC	Sets the pressure range at which the High Static Pressure Out of Range alarm is activated.
	SP Transducer High Range (Pa)	0 - 350 Pa	320 Pa	
U241	SP Transducer Low Range (inWC)	0.000 - 1.395 inWC	0.000 inWC	Sets the pressure range at which the Low Static Pressure Out of Range alarm is activated.
	SP Transducer Low Range (Pa)	0 - 348 Pa	0 Pa	

Table B.4 Service Menu Alarm Settings by Line ID

Line ID	Parameter Name	Range	Default Setting	Description
S202	Return Sensor Alarms Enable	Disabled Enabled	Enabled	Enables or disables the return temperature and humidity sensor alarms.
	Return Sensor Alarms Init Delay	10 - 9999 sec	90 sec	
S203	High Return Temperature Alarm	34 - 210 °F 1.0 - 99.0 °C	100 °F	Sets the temperature threshold for the High/Low Return Temperature alarms.
	Low Return Temperature Alarm	34 - 210 °F 1.0 - 99.0 °C	65 °F	

Table B.4 Service Menu Alarm Settings by Line ID (continued)

Line ID	Parameter Name	Range	Default Setting	Description
S204	High Return Humidity Alarm	1.0 - 99.0 %	0.65	Sets the humidity threshold for the High/Low Return Temperature alarms.
	Low Return Humidity Alarm	1.0 - 99.0 %	0.35	
S205	Sensor A Alarms Enable	Disabled Enabled	Disabled	Enables or disables the alarms associated with Sensor A and sets the time delay before the alarm is announced.
	Sensor A Alarms Init Delay	10 - 9999 sec	90 sec	
S206	Sensor A Low Temperature Alarm	34 - 210 °F 1.0 - 99.0 °C	55 °F	Sets the temperature threshold when Sensor A High/Low Temperature alarm will occur
	Sensor A High Temperature Alarm	34 - 210 °F 1.0 - 99.0 °C	90 °F	
S207	Sensor A Low Humidity Alarm	1.0 - 99.0%	30.0%	Sets the temperature threshold when Sensor A High/Low Humidity alarm will occur
	Sensor A High Humidity Alarm	1.0 - 99.0%	70.0%	
S208	Warning Activates Alarm Relay	No Yes	Yes	When set for Yes, a Warning event type will activate the Alarm Relay in addition to an Alarm event type.
S209	K11 (WA Relay) Active On	0 = Dehum 1 = Warning 2 = Emergency Pwr 3 = Freecooling 4 = FC Start	Warning	The Warning Relay (WA Relay) can be activated for different purposes; during a Call of Dehumidification, during a Warning event type, when unit is on Emergency Power and a Customer Input Alarm is configured for Emergency Pwr, during Freecooling, or during Freecooling (FC) Start.
S210	K11 (WA Relay) and AL Relay	Direct Reverse	Direct	Determines whether the K11 (WA Relay) is Direct or Reverse acting.
S211	Water Alarm Shuts Down Unit	No Yes	No	The controller can be configured to shut the following down during an active Water Alarm: <ul style="list-style-type: none"> Shutdown the entire unit Shutdown Humidification operation
	Water Alarm Hum Fill Down	No Yes	No	
S21A	Loss of Flow Compressor Timer	0 - 180 sec	0 sec	Allows setting a maximum pump down time during a loss of flow condition to prevent causing a high-pressure alarm due to pump down with no water/glycol flow to the condenser; hidden unless pump down is enabled; applies only to water/glycol cooled systems
S21B	Loss of Flow Threshold	0 - 100 %	0.1	Sets the threshold for call for cooling (CFC) loss of flow.
S213	Supply Sensor Alarms Enable	Disabled Enabled	Disabled	Enables or disables the supply sensor alarms. If the unit is not equipped with a supply temperature sensor, then this parameter will show Disabled. A user may also select the time delay before the alarm will become active.
	Supply Sensor Alarms Init Delay	10 - 9999 sec	90 sec	

Table B.4 Service Menu Alarm Settings by Line ID (continued)

Line ID	Parameter Name	Range	Default Setting	Description
S214	High Supply Temperature	34 - 210 °F 1.0 - 99.0 °C	75 °F	Sets the high and low supply temperature threshold that the alarms will be triggered at.
	Low Supply Temperature	34 - 210 °F 1.0 - 99.0 °C	50 °F	
S215	Dew Point Alarms Enable	Disabled Enabled	Disabled	Enables or disables the Return Air Dew Point alarm. Dew Point alarms can be enabled with any humidity control type. Dew point alarms may be used with or without humidification or dehumidification options selected. A user may adjust the time delay before the alarm is activated.
	Dew Point Alarms Init Delay	10 - 9999 sec	90 sec	
S216	High Dew Point	34 - 210 °F 1.0 - 99.0 °C	59 °F	Sets the high/low dew point threshold.
	Low Dew Point	34 - 210 °F 1.0 - 99.0 °C	39 °F	
S217	Sensor A Dew Point Alarms Enable	Disabled Enabled	Disabled	Enables or disables the optional Sensor A Dew Point alarm. Dew Point alarms can be enabled with any humidity control type. Dew point alarms may be used with or without humidification or dehumidification options selected. A user may adjust the time delay before the alarm is activated.
	Sensor A Dew Point Alarms Init Delay	10 - 9999 sec	90 sec	
S218	High Dew Point Sensor A	34 - 210 °F 1.0 - 99.0 °C	62 °F	Sets the high/low Sensor A dew point. thresholds.
	Low Dew Point Sensor A	34 - 210 °F 1.0 - 99.0 °C	36 °F	
S219	Remote Sensor Alarms Enable	0 = Disabled 1 = Com Set 2 = Sep Set	Disabled	Disable prevents remote temperature sensor alarms from occurring. Com Set (common setting) allows remote alarm activation based on a common alarm setting. Sep Set (separate setting) allows the user to program unique temperature alarm settings. A user may adjust the time delay before the alarm is activated.
	Remote Sensor Alarms Init Delay	10 - 9999 sec	180 sec	
S220	High Remote Temperature	34 - 210 °F 1.0 - 99.0 °C	90 °F	Sets the high/low Remote Sensor alarm thresholds.
	Low Remote Temperature	34 - 210 °F 1.0 - 99.0 °C	55 °F	
S222	EEV Alarmboard	0 = NO 1 = NC	1 (NC)	
S22A	Operation on Sensor Failure	0 = Cooling 1 = Shutdown	0 (Cooling)	Selects function to occur if the temperature control sensor fails. Full = Full CFC. Hold = hold last CFC.
	Operation on Sensor Failure Cooling Mode	0 = Full 1 = Hold	0 (Full)	

Table B.4 Service Menu Alarm Settings by Line ID (continued)

Line ID	Parameter Name	Range	Default Setting	Description
S224 - S233, S23A,	Customer Input 1 - 11	0 = Smoke 1 = Water Alarm 2 = C PMP Alarm 3 = Flow Alarm 4 = StdbY G Pump 5 = StdbY Unit 6 = C-Input 1 7 = C-Input 2 8 = C-Input 3 9 = C-Input 4 10 = Rht Lockout 11 = Hum Lockout 12 = Rht+Hum Lock 13 = Comp Lockout 14 = Call Service 15 = High Temp 16 = Air Loss 17 = FC Lockout 18 = Heater Alarm 19 = Flow AL SD 20 = Flow AL LC	1 (Water Alarm) for inputs 1-4 38 (Not Used) for inputs 5-11	Selects the device and operation of the Customer Inputs. Each event reflects a different alarm scenario and possible action to the unit. A user may select whether the customer input is normally-open or normally-closed. If the parameter is configured for Factory STD, it then indicates that this input is factory configured and is not configurable in the field.

Table B.4 Service Menu Alarm Settings by Line ID (continued)

Line ID	Parameter Name	Range	Default Setting	Description
S224 - S233, S23A, (Cont'd)	Customer Input 1 - 11 (Cont'd)	21 = Comp Lock PD 22 = Enable FC 23 = HTRJ VFD 24 = HTRJ SPD 25 = Fire Alarm 26 = 2nd Setpoint 27 = Emergency Pwr 28 = LSI 29 = Cond 1 Fail 30 = Cond 2 Fail 31 = D-Scroll Red 32 = Swap Valve 33 = EC Fan Fault 34 = Eco Airflow 35 = Damper Switch 36 = Power A 37 = Power B 38 = Not Used 39 = Flow AL LFC 40 = Hand Mode 41 = Fan Overrd. 42 = Cool Overrd	1 (Water Alarm) for inputs 1-4 38 (Not Used) for inputs 5-11	Selects the device and operation of the Customer Inputs. Each event reflects a different alarm scenario and possible action to the unit. A user may select whether the customer input is normally-open or normally-closed. If the parameter is configured for Factory STD, it then indicates that this input is factory configured and is not configurable in the field.
S224 - S233, S23A, (Cont'd)	Customer Input Active open/closed	Closed Open	Closed	A user may select if the customer input is active when contacts are open or closed
S236	Event Delay Time (sec)	10 - 9999 sec	10 sec	Main Fan Overload
	Event Enabled	Disabled Enabled	Enabled	
	Event: MAIN FAN OVERLOAD	MESSAGE WARNING ALARM	ALARM	
S237	Initial Loss of Airflow Delay	10 - 600 sec	30 sec	Loss of Airflow
	Event Delay Time (sec)	10 - 9999 sec	30 sec	
	Event Enabled	Disabled Enabled	Enabled	

Table B.4 Service Menu Alarm Settings by Line ID (continued)

Line ID	Parameter Name	Range	Default Setting	Description
	Event: LOSS OF AIRFLOW	MESSAGE WARNING ALARM	ALARM	
S238	Event Delay Time (sec)	10 - 9999 sec	10 sec	Clogged Filters
	Event Enabled	Disabled Enabled	Enabled	
	Event: CLOGGED FILTERS	MESSAGE WARNING ALARM	WARNING	
S239	Event Delay Time (sec)	10 - 9999 sec	30 sec	High Room Temperature
	Event Enabled	Disabled Enabled	Enabled	
	Event: HIGH ROOM TEMP	MESSAGE WARNING ALARM	WARNING	
S240	Event Delay Time (sec)	10 - 9999 sec	30 sec	Low Room Temperature
	Event Enabled	Disabled Enabled	Enabled	
	Event: LOW ROOM TEMP	MESSAGE WARNING ALARM	WARNING	
S241	Event Delay Time (sec)	10 - 9999 sec	30 sec	High Room Humidity
	Event Enabled	Disabled Enabled	Enabled	
	Event: HIGH ROOM HUM	MESSAGE WARNING ALARM	WARNING	
S242	Event Delay Time (sec)	10 - 9999 sec	30 sec	Low Room Humidity
	Event Enabled	Disabled Enabled	Enabled	
	Event: LOW ROOM HUM	MESSAGE WARNING ALARM	WARNING	
S243	Event Delay Time (sec)	10 - 9999 sec	30 sec	High Temperature Sensor A
	Event Enabled	Disabled Enabled	Disabled	

Table B.4 Service Menu Alarm Settings by Line ID (continued)

Line ID	Parameter Name	Range	Default Setting	Description
	Event: HIGH TEMP SENSOR A	MESSAGE WARNING ALARM	WARNING	
S244	Event Delay Time (sec)	10 - 9999 sec	30 sec	Low Temperature Sensor A
	Event Enabled	Disabled Enabled	Disabled	
	Event: LOW TEMP SENSOR A	MESSAGE WARNING ALARM	WARNING	
S245	Event Delay Time (sec)	10 - 9999 sec	30 sec	High Humidity Sensor A
	Event Enabled	Disabled Enabled	Disabled	
	Event: HIGH HUM SENSOR A	MESSAGE WARNING ALARM	WARNING	
S246	Event Delay Time (sec)	10 - 9999 sec	30 sec	Low Humidity Sensor A
	Event Enabled	Disabled Enabled	Disabled	
	Event: LOW HUM SENSOR A	MESSAGE WARNING ALARM	WARNING	
S249	Event Delay Time (sec)	–	–	Compressor 1 Overload
	Event Enabled	Disabled Enabled	Enabled	
	Event: COMP 1 OVERLOAD	MESSAGE WARNING ALARM	ALARM	
S250	Event Delay Time (sec)	–	–	Compressor 2 Overload
	Event Enabled	Disabled Enabled	Enabled	
	Event: COMP 2 OVERLOAD	MESSAGE WARNING ALARM	ALARM	

Table B.4 Service Menu Alarm Settings by Line ID (continued)

Line ID	Parameter Name	Range	Default Setting	Description
S251	Event Delay Time (sec)	–	–	Circuit 1 High Pressure
	Event Enabled	Disabled Enabled	Enabled	
	Event: CIRCUIT 1 HIGH PRESS	MESSAGE WARNING ALARM	ALARM	
S252	Event Delay Time (sec)	–	–	Circuit 2 High Pressure
	Event Enabled	Disabled Enabled	Enabled	
	Event: CIRCUIT 2 HIGH PRESS	MESSAGE WARNING ALARM	ALARM	
S253	Event Delay Time (sec)	–	–	Circuit 1 Low Pressure
	Event Enabled	Disabled Enabled	Enabled	
	Event: CIRCUIT 1 LOW PRESS	MESSAGE WARNING ALARM	ALARM	
S254	Event Delay Time (sec)	–	–	Circuit 2 Low Pressure
	Event Enabled	Disabled Enabled	Enabled	
	Event: CIRCUIT 2 LOW PRESS	MESSAGE WARNING ALARM	ALARM	
S255	Event Delay Time (sec)	–	–	Circuit 1 Pump down Failure
	Event Enabled	Disabled Enabled	Enabled	
	Event: CIRCUIT 1 PUMPD. FAIL	MESSAGE WARNING ALARM	ALARM	
S256	Event Delay Time (sec)	–	–	Circuit 2 Pump down Failure
	Event Enabled	Disabled Enabled	Enabled	
	Event: CIRCUIT 2 PUMPD. FAIL	MESSAGE WARNING ALARM	ALARM	
S257	Event Delay Time	–	–	Digital Scroll 1 High Temperature

Table B.4 Service Menu Alarm Settings by Line ID (continued)

Line ID	Parameter Name	Range	Default Setting	Description
	(sec)			
	Event Enabled	Disabled Enabled	Enabled	
	Event: DIG SCROLL1 HIGH TEMP	MESSAGE WARNING ALARM	ALARM	
S258	Event Delay Time (sec)	–	–	Digital Scroll 2 High Temperature
	Event Enabled	Disabled Enabled	Enabled	
	Event: DIG SCROLL2 HIGH TEMP	MESSAGE WARNING ALARM	ALARM	
S259	Event Reset Type	0 = AR 1 = MR	0 (AR)	Electric Heat High Temp AR = Auto Reset, MR = Manual Reset
	Event Delay Time (sec)	10 - 9999 sec	10 sec	
	Event Enabled	Disabled Enabled	Enabled	
	Event: EL HEAT HIGH TEMP	MESSAGE WARNING ALARM	ALARM	
S262	Event Delay Time (sec)	10 - 9999 sec	10 sec	Working HRS Exceeded
	Event Enabled	Disabled Enabled	Enabled	
	Event: UNIT HRS EXCEEDED	MESSAGE WARNING ALARM	WARNING	
S263	Event Delay Time (sec)	10 - 9999 sec	10 sec	Smoke Detected
	Event Enabled	Disabled Enabled	Enabled	
	Event: SMOKE DETECTED	MESSAGE WARNING ALARM	ALARM	
S264	Event Delay Time (sec)	10 - 9999 sec	10 sec	Water Under Floor
	Event Enabled	Disabled Enabled	Enabled	
	Event: WATER UNDER FLOOR	MESSAGE WARNING ALARM	ALARM	

Table B.4 Service Menu Alarm Settings by Line ID (continued)

Line ID	Parameter Name	Range	Default Setting	Description
S265	Event Delay Time (sec)	10 - 9999 sec	10 sec	Cond Pump High Water
	Event Enabled	Disabled Enabled	Enabled	
	Event: COND PUMP-HIGH WATER	MESSAGE WARNING ALARM	ALARM	
S266	Event Delay Time (sec)	0 = AR 1 = MR	0 (AR)	Loss of Flow AR = Auto Reset MR = Manual Reset
	Event Enabled	10 - 9999 sec	10 sec	
	Event Number 107 Enabled	Disabled Enabled	Enabled	
	Event: LOSS OF FLOW	MESSAGE WARNING ALARM	ALARM	
S267	Event Delay Time (sec)	10 - 9999 sec	10 sec	Standby Glycol Pump ON
	Event Enabled	Disabled Enabled	Enabled	
	Event: STANDBY GLYCOL PUMP ON	MESSAGE WARNING ALARM	ALARM	
S268	Event Delay Time (sec)	10 - 9999 sec	10 sec	Standby Unit ON
	Event Enabled	Disabled Enabled	Enabled	
	Event: STANDBY UNIT ON	MESSAGE WARNING ALARM	ALARM	
S269	Event Delay Time (sec)	10 - 9999 sec	10 sec	Humidifier Problem
	Event Enabled	Disabled Enabled	Enabled	
	Event: HUMIDIFIER PROBLEM	MESSAGE WARNING ALARM	ALARM	
S270	Event Delay Time (sec)	10 - 9999 sec	300 sec	No Connection w/ Unit 1
	Event Enabled	Disabled Enabled	Enabled	
	Event: NO CONNECTION W/ UNIT1	MESSAGE WARNING ALARM	WARNING	

Table B.4 Service Menu Alarm Settings by Line ID (continued)

Line ID	Parameter Name	Range	Default Setting	Description
S271	Event Delay Time (sec)	–	–	Unit X Disconnected
	Event Enabled	Disabled Enabled	Enabled	
	Event: UNIT 01 DISCONNECTED	MESSAGE WARNING ALARM	WARNING	
S272	Event: Loss of power Autoreset Delay	60 - 3600 sec	300 sec	Loss of Power
	Event Enabled	Disabled Enabled	Enabled	
	Event: LOSS OF POWER	MESSAGE WARNING ALARM	WARNING	
S275	Event Delay Time (sec)	10 - 9999 sec	10 sec	Customer Input 1
	Event Enabled	Disabled Enabled	Enabled	
	Event: CUSTOMER INPUT 1	MESSAGE WARNING ALARM	ALARM	
S276	Event Delay Time (sec)	10 - 9999 sec	10 sec	Customer Input 2
	Event Enabled	Disabled Enabled	Enabled	
	Event: CUSTOMER INPUT 2	MESSAGE WARNING ALARM	ALARM	
S277	Event Delay Time (sec)	10 - 9999 sec	10 sec	Customer Input 3
	Event Enabled	Disabled Enabled	Enabled	
	Event: CUSTOMER INPUT 3	MESSAGE WARNING ALARM	ALARM	
S278	Event Delay Time (sec)	10 - 9999 sec	10 sec	Customer Input 4
	Event Enabled	Disabled Enabled	Enabled	
	Event: CUSTOMER INPUT 4	MESSAGE WARNING ALARM	ALARM	
S279	Event Delay Time	10 - 9999 sec	10 sec	Call Service

Table B.4 Service Menu Alarm Settings by Line ID (continued)

Line ID	Parameter Name	Range	Default Setting	Description
	(sec)			
	Event Enabled	Disabled Enabled	Enabled	
	Event: CALL SERVICE	MESSAGE WARNING ALARM	ALARM	
S280	Event Delay Time (sec)	10 - 9999 sec	10 sec	High Temperature
	Event Enabled	Disabled Enabled	Enabled	
	Event: HIGH TEMPERATURE	MESSAGE WARNING ALARM	ALARM	
S281	Event Delay Time (sec)	10 - 9999 sec	10 sec	Loss of Air Blower 1
	Event Enabled	Disabled Enabled	Disabled	
	Event: LOSS OF AIR BLOWER 1	MESSAGE WARNING ALARM	ALARM	
S282	Event Delay Time (sec)	10 - 9999 sec	10 sec	Reheat Lockout
	Event Enabled	Disabled Enabled	Enabled	
	Event: REHEAT LOCKOUT	MESSAGE WARNING ALARM	WARNING	
S283	Event Delay Time (sec)	10 - 9999 sec	10 sec	Humidifier Lockout
	Event Enabled	Disabled Enabled	Enabled	
	Event: HUMIDIFIER LOCKOUT	MESSAGE WARNING ALARM	WARNING	
S284	Event Delay Time (sec)	10 - 9999 sec	10 sec	FC Lockout
	Event Enabled	Disabled Enabled	Enabled	
	Event: FC LOCKOUT	MESSAGE WARNING ALARM	WARNING	

Table B.4 Service Menu Alarm Settings by Line ID (continued)

Line ID	Parameter Name	Range	Default Setting	Description
S285	Compressor Lockout Option	0 = ALL 1 = 1 (A) 2 = 2 (A) 3 = 1B 4 = 2B 5 = 1A + 2A 6 = 1B + 2B 7 = 1A + 1B 8 = 2A + 2B	0(ALL)	Compressor(s) Lockout
	Event Delay Time (sec)	10 - 9999 sec	10 sec	
	Event Enabled	Disabled Enabled	Enabled	
	Event: COMPRESSOR (S) LOCKOUT	MESSAGE WARNING ALARM	WARNING	
S27B	Edit Cust Input 1	(20 digits) 0-9 A-Z a-z &* / . + - _ : @ \	CUSTOMER INPUT 1	Edit Customer Input 1 Text
S27C	Edit Cust Input 2	(20 digits) 0-9 A-Z a-z &* / . + - _ : @ \	CUSTOMER INPUT 2	Edit Customer Input 2 Text
S27D	Edit Cust Input 3	(20 digits) 0-9 A-Z a-z &* / . + - _ : @ \	CUSTOMER INPUT 3	Edit Customer Input 3 Text
S27E	Edit Cust Input 4	(20 digits) 0-9 A-Z a-z &* / . + - _ : @ \	CUSTOMER INPUT 4	Edit Customer Input 4 Text
S288	Event Delay Time (sec)	10 - 9999 sec	10 sec	Compressor 1 Short Cycle
	Event Enabled	Disabled Enabled	Enabled	
	Event: COMP 1 SHORT CYCLE	MESSAGE WARNING ALARM	WARNING	
S289	Event Delay Time (sec)	10 - 9999 sec	10 sec	Compressor 2 Short Cycle
	Event Enabled	Disabled	Enabled	

Table B.4 Service Menu Alarm Settings by Line ID (continued)

Line ID	Parameter Name	Range	Default Setting	Description
		Enabled		
	Event: COMP 2 SHORT CYCLE	MESSAGE WARNING ALARM	WARNING	
S290	Event Delay Time (sec)	10 - 9999 sec	10 sec	Emergency Power
	Event Enabled	Disabled Enabled	Enabled	
	Event: EMERGENCY POWER	MESSAGE WARNING ALARM	WARNING	
S291	Event Delay Time (sec)	10 - 9999 sec	10 sec	Condenser 1 Failure
	Event Enabled	Disabled Enabled	Enabled	
	Event: CONDENSER 1 FAILURE	MESSAGE WARNING ALARM	WARNING	
S292	Event Delay Time (sec)	10 - 9999 sec	10 sec	Condenser 2 Failure
	Event Enabled	Disabled Enabled	Enabled	
	Event: CONDENSER 2 FAILURE	MESSAGE WARNING ALARM	WARNING	
S293	Event Delay Time (sec)	10 - 9999 sec	15 sec	EC Fan Fault
	Event Enabled	Disabled Enabled	Enabled	
	Event: EC FAN FAULT	MESSAGE WARNING ALARM	ALARM	
S294	Event Delay Time (sec)	10 - 9999 sec	30 sec	High Supply Temperature
	Event Enabled	Disabled Enabled	Enabled	
	Event: HI SUPPLY TEMPERATURE	MESSAGE WARNING ALARM	WARNING	
S295	Event Delay Time (sec)	10 - 9999 sec	30 sec	Low Supply Temperature
	Event Enabled	Disabled Enabled	Enabled	

Table B.4 Service Menu Alarm Settings by Line ID (continued)

Line ID	Parameter Name	Range	Default Setting	Description
	Event: LO SUPPLY TEMPERATURE	MESSAGE WARNING ALARM	WARNING	
S296	Event Delay Time (sec)	10 - 9999 sec	10 sec	Reduced Eco Airflow
	Event Enabled	Disabled Enabled	Enabled	
	Event: REDUCED ECO AIRFLOW	MESSAGE WARNING ALARM	WARNING	
S297	Event Delay Time (sec)	10 - 9999 sec	10 sec	Eco High Temperature Override
	Event Enabled	Disabled Enabled	Enabled	
	Event: ECO HI TEMP OVERRIDE	MESSAGE WARNING ALARM	WARNING	
S298	Event Delay Time (sec)	10 - 9999 sec	10 sec	Temperature Control Sensor Fail
	Event Enabled	Disabled Enabled	Enabled	
	Event: TEMP CTRL SENSOR FAIL	MESSAGE WARNING ALARM	ALARM	
S2A2	Event Delay Time (sec)	10 - 9999 sec	30 sec	High Dew Point
	Event Enabled	Disabled Enabled	Enabled	
	Event: HIGH DEW POINT	MESSAGE WARNING ALARM	WARNING	
S2A3	Event Delay Time (sec)	10 - 9999 sec	30 sec	Low Dew Point
	Event Enabled	Disabled Enabled	Enabled	
	Event: LOW DEW POINT	MESSAGE WARNING ALARM	WARNING	
S2A4	Event Delay Time (sec)	10 - 9999 sec	30 sec	High Dew Point Sensor A
	Event Enabled	Disabled Enabled	Enabled	

Table B.4 Service Menu Alarm Settings by Line ID (continued)

Line ID	Parameter Name	Range	Default Setting	Description
	Event: HI DEW POINT SENSOR A	MESSAGE WARNING ALARM	WARNING	
S2A5	Event Delay Time (sec)	10 - 9999 sec	30 sec	Low Dew Point Sensor A
	Event Enabled	Disabled Enabled	Enabled	
	Event: LOW DEW POINT SENSOR A	MESSAGE WARNING ALARM	WARNING	
S2A6	Event Delay Time (sec)	10 - 9999 sec	30 sec	High Remote Sensor
	Event Enabled	Disabled Enabled	Enabled	
	—	MESSAGE WARNING ALARM	WARNING	
S2A7	Event Delay Time (sec)	10 - 9999 sec	30 sec	Low Remote Sensor
	Event Enabled	Disabled Enabled	Enabled	
	—	MESSAGE WARNING ALARM	WARNING	
S2A8	Event Delay Time (sec)	10 - 9999 sec	10 sec	Power A 'Failure
	Event Enabled	Disabled Enabled	Enabled	
	Event: POWER 'A' FAILURE	MESSAGE WARNING ALARM	ALARM	
S2A9	Event Delay Time (sec)	10 - 9999 sec	10 sec	Power B Failure
	Event Enabled	Disabled Enabled	Enabled	
	Event: POWER 'B' FAILURE	MESSAGE WARNING ALARM	ALARM	
S2B1	Event Delay Time (sec)	10 - 9999 sec	10 sec	Airflow Sensor Failure
	Event Enabled	Disabled Enabled	Enabled	

Table B.4 Service Menu Alarm Settings by Line ID (continued)

Line ID	Parameter Name	Range	Default Setting	Description
	Event: AIRFLOW SENSOR FAIL	MESSAGE WARNING ALARM	WARNING	
S2B2	Event Delay Time (sec)	10 - 9999 sec	30 sec	Humidity Control Sensor Failure
	Event Enabled	Disabled Enabled	Enabled	
	Event: HUM CTRL SENSOR FAILURE	MESSAGE WARNING ALARM	WARNING	
S2B6	Event Delay Time (sec)	10 - 9999 sec	120 sec	Low Static Pressure
	Event Enabled	Disabled Enabled	Disabled	
	Event: LOW STATIC PRESSURE	MESSAGE WARNING ALARM	WARNING	
S2B7	Event Delay Time (sec)	10 - 9999 sec	120 sec	High Static Pressure
	Event Enabled	Disabled Enabled	Disabled	
	Event: HIGH STATIC PRESSURE	MESSAGE WARNING ALARM	WARNING	
S2B8	Event Delay Time (sec)	10 - 9999 sec	150 sec	Static Pressure 1 Out of Range
	Event Enabled	Disabled Enabled	Disabled	
	Event: STATPR 1 OUT OF RANGE	MESSAGE WARNING ALARM	WARNING	
S2B9	Event Delay Time (sec)	10 - 9999 sec	150 sec	Static Pressure 2 Out of Range
	Event Enabled	Disabled Enabled	Disabled	
	Event: STATPR 2 OUT OF RANGE	MESSAGE WARNING ALARM	WARNING	
S2C1	Event Delay Time (sec)	10 - 9999 sec	150 sec	Static Pressure 3 Out of Range
	Event Enabled	Disabled Enabled	Disabled	

Table B.4 Service Menu Alarm Settings by Line ID (continued)

Line ID	Parameter Name	Range	Default Setting	Description
	Event: STATPR 3 OUT OF RANGE	MESSAGE WARNING ALARM	WARNING	
S2C2	Event Delay Time (sec)	10 - 9999 sec	150 sec	Static Pressure 4 Out of Range
	Event Enabled	Disabled Enabled	Disabled	
	Event: STATPR 4 OUT OF RANGE	MESSAGE WARNING ALARM	WARNING	
S2C3	Event Delay Time (sec)	10 - 9999 sec	120 sec	Static Pressure 1 Sensor Failure
	Event Enabled	Disabled Enabled	Disabled	
	Event: STAT PR 1 SENS FAIL	MESSAGE WARNING ALARM	ALARM	
S2C4	Event Delay Time (sec)	10 - 9999 sec	120 sec	Static Pressure 2 Sensor Failure
	Event Enabled	Disabled Enabled	Disabled	
	Event: STAT PR 2 SENS FAIL	MESSAGE WARNING ALARM	ALARM	
S2C5	Event Delay Time (sec)	10 - 9999 sec	120 sec	Static Pressure 3 Sensor Failure
	Event Enabled	Disabled Enabled	Disabled	
	Event: STAT PRES 3 SENS FAIL	MESSAGE WARNING ALARM	ALARM	
S2C6	Event Delay Time (sec)	10 - 9999 sec	120 sec	Static Pressure 4 Sensor Failure
	Event Enabled	Disabled Enabled	Disabled	
	Event: STAT PRES 4 SENS FAIL	MESSAGE WARNING ALARM	ALARM	
S2D1	Event Delay Time (sec)	10 - 9999 sec	10 sec	Compressor 1A Overload
	Event Enabled	Disabled Enabled	Enabled	

Table B.4 Service Menu Alarm Settings by Line ID (continued)

Line ID	Parameter Name	Range	Default Setting	Description
	Event: COMP 1A OVERLOAD	MESSAGE WARNING ALARM	ALARM	
S2D2	Event Delay Time (sec)	10 - 9999 sec	10 sec	Compressor 1B Overload
	Event Enabled	Disabled Enabled	Enabled	
	Event: COMP 1B OVERLOAD	MESSAGE WARNING ALARM	ALARM	
S2D3	Event Delay Time (sec)	10 - 9999 sec	10 sec	Compressor 2A Overload
	Event Enabled	Disabled Enabled	Enabled	
	Event: COMP 2A OVERLOAD	MESSAGE WARNING ALARM	ALARM	
S2D4	Event Delay Time (sec)	10 - 9999 sec	10 sec	Compressor 2B Overload
	Event Enabled	Disabled Enabled	Enabled	
	Event: COMP 2B OVERLOAD	MESSAGE WARNING ALARM	ALARM	
S2D5	Event Delay Time (sec)	10 - 9999 sec	10 sec	Compressor 1A High Temperature
	Event Enabled	Disabled Enabled	Enabled	
	Event: COMP 1A HIGH TEMP	MESSAGE WARNING ALARM	ALARM	
S2D6	Event Delay Time (sec)	10 - 9999 sec	10 sec	Compressor 1B High Temperature
	Event Enabled	Disabled Enabled	Enabled	
	Event: COMP 1B HIGH TEMP	MESSAGE WARNING ALARM	ALARM	
S2D7	Event Delay Time (sec)	10 - 9999 sec	10 sec	Compressor 2A High Temperature
	Event Enabled	Disabled Enabled	Enabled	

Table B.4 Service Menu Alarm Settings by Line ID (continued)

Line ID	Parameter Name	Range	Default Setting	Description
	Event: COMP 2A HIGH TEMP	MESSAGE WARNING ALARM	ALARM	
S2D8	Event Delay Time (sec)	10 - 9999 sec	10 sec	Compressor 2B High Temperature
	Event Enabled	Disabled Enabled	Enabled	
	Event: COMP 2B HIGH TEMP	MESSAGE WARNING ALARM	ALARM	
S2D9	Event Delay Time (sec)	10 - 9999 sec	10 sec	Compressor 1A Short Cycle
	Event Enabled	Disabled Enabled	Enabled	
	Event: COMP 1A SHORT CYCLE	MESSAGE WARNING ALARM	WARNING	
S2E1	Event Delay Time (sec)	10 - 9999 sec	10 sec	Compressor 1B Short Cycle
	Event Enabled	Disabled Enabled	Enabled	
	Event: COMP 1B SHORT CYCLE	MESSAGE WARNING ALARM	WARNING	
S2E2	Event Delay Time (sec)	10 - 9999 sec	10 sec	Compressor 2A Short Cycle
	Event Enabled	Disabled Enabled	Enabled	
	Event: COMP 2A SHORT CYCLE	MESSAGE WARNING ALARM	WARNING	
S2E5	Event Delay Time (sec)	10 - 9999 sec	10 sec	Compressor 2B Short Cycle
	Event Enabled	Disabled Enabled	Enabled	
	Event: COMP 2B SHORT CYCLE	MESSAGE WARNING ALARM	WARNING	
S2E6	Event Delay Time (sec)	10 - 9999 sec	60 sec	GCB Ambient Temperature Differential
	Event Enabled	Disabled Enabled	Enabled	

Table B.4 Service Menu Alarm Settings by Line ID (continued)

Line ID	Parameter Name	Range	Default Setting	Description
	Event: GCD AMBIENT TEMP DIFF	MESSAGE WARNING ALARM	WARNING	
S2E7	—	—	—	C1 Freeze Protection
	Event Enabled	Disabled Enabled	Enabled	
	Event: C1 FREEZE PROTECTION	MESSAGE WARNING ALARM	ALARM	
S2E8	—	—	—	C2 Freeze Protection
	Event Enabled	Disabled Enabled	Enabled	
	Event: C2 FREEZE PROTECTION	MESSAGE WARNING ALARM	ALARM	
S2E9	Event Delay Time (sec)	10 - 9999 sec	10 sec	Damper Failure
	Event Enabled	Disabled Enabled	Enabled	
	Event: DAMPER FAILURE	MESSAGE WARNING ALARM	ALARM	
SF2F	—	—	—	BMS Disconnected
	Event Enabled	Disabled Enabled	Enabled	
	Event: BMS DISCONNECTED	MESSAGE WARNING ALARM	WARNING	
S2F9	Phase Loss MB01 shuts unit down	0 = No 1 = Yes	1 (Yes)	Power 1 Phase Loss
	Event Delay Time (sec)	10 - 9999 sec	10 sec	
	Event Enabled	Disabled Enabled	Enabled	
	Event: POWER 1 PHASE LOSS	MESSAGE WARNING ALARM	ALARM	
S2G1	Phase Loss MB02 shuts unit down	0 = No 1 = Yes	1 (Yes)	Power 2 Phase Loss
	Event Delay Time (sec)	10 - 9999 sec	10 sec	
	Event Enabled	Disabled	Enabled	

Table B.4 Service Menu Alarm Settings by Line ID (continued)

Line ID	Parameter Name	Range	Default Setting	Description
		Enabled		
	Event: POWER 2 PHASE LOSS	MESSAGE WARNING ALARM	ALARM	
S2G2	Phase Loss MB03 shuts unit down	0 = No 1 = Yes	1 (Yes)	Power 3 Phase Loss
	Event Delay Time (sec)	10 - 9999 sec	10 sec	
	Event Enabled	Disabled Enabled	Enabled	
	Event: POWER 3 PHASE LOSS	MESSAGE WARNING ALARM	ALARM	
S2G3	Phase Loss MB04 shuts unit down	0 = No 1 = Yes	1 (Yes)	Power 4 Phase Loss
	Event Delay Time (sec)	10 - 9999 sec	10 sec	
	Event Enabled	Disabled Enabled	Enabled	
	Event: POWER 4 PHASE LOSS	MESSAGE WARNING ALARM	ALARM	
S2G4	Phase Loss MB05 shuts unit down	0 = No 1 = Yes	1 (Yes)	Power 5 Phase Loss
	Event Delay Time (sec)	10 - 9999 sec	10 sec	
	Event Enabled	Disabled Enabled	Enabled	
	Event: POWER 5 PHASE LOSS	MESSAGE WARNING ALARM	ALRM	
S2G5	Phase Loss MB06 shuts unit down	0 = No 1 = Yes	1 (Yes)	Power 6 Phase Loss
	Event Delay Time (sec)	10 - 9999 sec	10 sec	
	Event Enabled	Disabled Enabled	Enabled	
	Event: POWER 6 PHASE LOSS	MESSAGE WARNING ALARM	ALARM	
S2G6	Event Delay Time (sec)	10 - 9999 sec	60 sec	Flow Sensor Fail C1

Table B.4 Service Menu Alarm Settings by Line ID (continued)

Line ID	Parameter Name	Range	Default Setting	Description
	Event Enabled	Disabled Enabled	Enabled	
	Event: FLOW SENSOR FAIL C1	MESSAGE WARNING ALARM	WARNING	
S2G7	Event Delay Time (sec)	10 - 9999 sec	60 sec	Flow Sensor Fail C2
	Event Enabled	Disabled Enabled	Enabled	
	Event: FLOW SENSOR FAIL C2	MESSAGE WARNING ALARM	WARNING	
S2G8	Event Delay Time (sec)	10 - 9999 sec	60 sec	TSA Sensor Fail
	Event Enabled	Disabled Enabled	Enabled	
	Event: TSA SENSOR FAIL	MESSAGE WARNING ALARM	ALARM	
617	Event Delay Time (sec)	1 - 9999 sec	10 sec	XDU Pump Inverter Fail 1
	Event Enabled	Disabled Enabled	Enabled	
	Event: PUMP INVERTER FAIL 1	MESSAGE WARNING ALARM	ALARM	
618	Event Delay Time (sec)	1 - 9999 sec	10 sec	XDU Pump Inverter Fail 2
	Event Enabled	Disabled Enabled	Enabled	
	Event: PUMP INVERTER FAIL 2	MESSAGE WARNING ALARM	ALARM	
619	Event Delay Time (sec)	1 - 9999 sec	10 sec	XDU Pump Flow Fail 1
	Event Enabled	Disabled Enabled	Enabled	
	Event: PUMP FLOW FAIL 1	MESSAGE WARNING ALARM	ALARM	
620	Event Delay Time (sec)	1 - 9999 sec	10 sec	XDU Pump Flow Fail 2
	Event Enabled	Disabled	Enabled	

Table B.4 Service Menu Alarm Settings by Line ID (continued)

Line ID	Parameter Name	Range	Default Setting	Description
		Enabled		
	Event: PUMP FLOW FAIL 2	MESSAGE WARNING ALARM	ALARM	
621	Event Delay Time (sec)	1 - 9999 sec	10 sec	XDU Fluid Flow Check Filter
	Event Enabled	Disabled Enabled	Enabled	
	Event: CHECK WATER SYSTEM	MESSAGE WARNING ALARM	WARNING	
622	Event Delay Time (sec)	1 - 9999 sec	10 sec	The current XDU Supply Fluid Temperature is above the threshold
	Event Enabled	Disabled Enabled	Enabled	
	Event: HIGH SUPPLY WATER TEMP	MESSAGE WARNING ALARM	WARNING	
623	Event Delay Time (sec)	1 - 9999 sec	10 sec	The current XDU Return Fluid Temperature is above the threshold
	Event Enabled	Disabled Enabled	Enabled	
	Event: HIGH RETURN WATER TEMP	MESSAGE WARNING ALARM	WARNING	
624	Event Delay Time (sec)	1 - 9999 sec	10 sec	XDU Pump Operation with No Flow
	Event Enabled	Disabled Enabled	Enabled	
	Event: PUMP OPERATION WITH NO FLOW	MESSAGE WARNING ALARM	ALARM	
625	Event Delay Time (sec)	1 - 9999 sec	10 sec	XDU Supply Fluid Sensor Failure
	Event Enabled	Disabled Enabled	Enabled	
	Event: SUPPLY FLUID SENSOR FAILURE	MESSAGE WARNING ALARM	ALARM	
626	Event Delay Time (sec)	1 - 9999 sec	10 sec	XDU Return Fluid Sensor Failure
	Event Enabled	Disabled Enabled	Enabled	

Table B.4 Service Menu Alarm Settings by Line ID (continued)

Line ID	Parameter Name	Range	Default Setting	Description
	Event: RETURN FLUID SENSOR FAILURE	MESSAGE WARNING ALARM	ALARM	
627	Event Delay Time (sec)	1 - 9999 sec	10 sec	XDU Fluid Flow Sensor Failure
	Event Enabled	Disabled Enabled	Enabled	
	Event: FLOW SENSOR FAILURE	MESSAGE WARNING ALARM	ALARM	
628	Event Delay Time (sec)	1 - 9999 sec	-	Current working hours of fluid pump 1 are above the threshold
	Event Enabled	Disabled Enabled	Enabled	
	Event: PUMP 1 HOURS EXCEEDED	MESSAGE WARNING ALARM	WARNING	
629	Event Delay Time (sec)	1 - 9999 sec	-	Current working hours of fluid pump 2 are above the threshold
	Event Enabled	Disabled Enabled	Enabled	
	Event: PUMP 2 HOURS EXCEEDED	MESSAGE WARNING ALARM	WARNING	

B.4 Line IDs for Cascade Operation Parameters

Table B.5 Service Menu Cascade Parameters by Line ID

Line ID	Parameter Name	Range	Default Setting	Description
S515	Cascade Units	No Yes Cool/Heat Cooling Fan PI Fan Speed	No	User may select the method to which the next standby unit will stage ON. <ul style="list-style-type: none"> No = disabled Yes = enabled via TW Mode 1 Cool/Heat = enabled via TW Mode 1 Cooling = enabled via TW Mode 1 Fan PI = enabled via TW Mode 3 Fan speed = enabled via TW Mode 3
S516	Cascaded Units Delay	0 - 30 min	10 min	Once a Standby unit receives an ON command from the Master (U2U 1), the amount of time that must surpass prior to the standby unit staging ON
S517	Cascaded Units Quick Start	0 - 30 min	2 min	

Table B.5 Service Menu Cascade Parameters by Line ID (continued)

Line ID	Parameter Name	Range	Default Setting	Description
	Cascaded Units QS Delay	15 - 1800 sec	120 sec	After the Master (U2U 1) has restarted after a power cycle; this control delay time is used (Shorter time than S516). The timer changes back to using S516 when the time of power cycle is equal to S517 min/sec. NOTE: This setting is not required. If set to a value of 0, then S517 Cascade Units Quick-Start is disabled.
S518	Cascaded Units Control Delay	0 - 30 min	5 min	Once a standby unit has been cascaded ON, the amount of time that must surpass before the normal unit control is used.
S519	Cascaded Units OFF Delay	0 - 360 min	0 min	This timer starts to count down once a cascaded ON system has received an OFF request from the master. The cascaded unit will stop after this timer and S520 have elapsed.
S520	Cascaded Units Min Run	2 - 360 min	30 min	The minimum ON time the cascaded system will run before staging OFF, once energized.
S521	Start Next Unit at SYS Fan Speed	50 - 100%	100%	When the System (network) fan speed operates at or above S521, S516 timer is started. Once S516 has elapsed, the next single unit will energized. NOTE: Fan speed must be at or continuously above value set in S521. The timer restarts any time the fan speed falls below the value set in S521.
S522	Max. Intermediate System Speed	50 - 100 %	100%	Defines the value to which the System (network) fan speed may increase to when not all units in the network are in operation
S523	Stop Next Unit at SYS Fan Speed	20 - 70 %	70%	When the current System (network) fan speed operates at or below S523, two timers must elapse before the cascaded ON unit turns OFF; S519 and S520.
S524	Cascaded Units OFF Master Delay	0 - 360 min	1 min	In the event that the Virtual Master takes control, the new Master unit shall control the staging OFF of currently operating units for the amount of time set in S524. After S524 time has elapsed, S519 value is used.

Connect with Vertiv on Social Media



<https://www.facebook.com/vertiv/>



<https://www.instagram.com/vertiv/>



<https://www.linkedin.com/company/vertiv/>



<https://www.twitter.com/Vertiv/>



Vertiv.com | Vertiv Headquarters, 505 N. Cleveland Ave., Westerville, OH 43082 USA

© 2023 Vertiv Group Corp. All rights reserved. Vertiv™ and the Vertiv logo are trademarks or registered trademarks of Vertiv Group Corp. All other names and logos referred to are trade names, trademarks or registered trademarks of their respective owners. While every precaution has been taken to ensure accuracy and completeness here, Vertiv Group Corp. assumes no responsibility, and disclaims all liability, for damages resulting from use of this information or for any errors or omissions.

SL-70320_REV7_06-23