



Liebert®

FDC™

User Manual

The information contained in this document is subject to change without notice and may not be suitable for all applications. While every precaution has been taken to ensure the accuracy and completeness of this document, Vertiv assumes no responsibility and disclaims all liability for damages resulting from use of this information or for any errors or omissions. Refer to other local practices or building codes as applicable for the correct methods, tools, and materials to be used in performing procedures not specifically described in this document.

The products covered by this instruction manual are manufactured and/or sold by Vertiv. This document is the property of Vertiv and contains confidential and proprietary information owned by Vertiv. Any copying, use or disclosure of it without the written permission of Vertiv is strictly prohibited.

Names of companies and products are trademarks or registered trademarks of the respective companies. Any questions regarding usage of trademark names should be directed to the original manufacturer.

Technical Support Site

If you encounter any installation or operational issues with your product, check the pertinent section of this manual to see if the issue can be resolved by following outlined procedures. Visit <https://www.VertivCo.com/en-us/support/> for additional assistance.

TABLE OF CONTENTS

SUPPORT INFORMATION	IV
IMPORTANT SAFETY INSTRUCTIONS	1
1.0 SAFETY PRECAUTIONS	2
2.0 UNPACKING AND INSPECTIONS	3
2.1 External Inspections	3
2.2 Handling and Unloading	3
2.2.1 Handling Considerations	3
2.2.2 Unloading the Unit from the Pallet	8
2.3 Internal Inspections	10
3.0 LOCATING THE LIEBERT FDC	11
3.1 Location Considerations	11
3.1.1 Recommended Minimum Service Clearances	11
3.1.2 Heat Output	12
3.1.3 Operating Environment	12
3.2 Final Positioning of the Liebert FDC	12
3.2.1 Seismic Floor Stand (Optional)	12
4.0 POWER AND CONTROL WIRING	14
4.1 Input Power Connections	14
4.2 System Grounding	21
4.3 Output Power Connections	21
4.4 Control Wiring Connections	22
4.4.1 Current Plus Monitoring™—Optional	22
4.4.2 Liebert LDMF™—Optional	25
5.0 INTRODUCTION TO LIEBERT FDC OPERATION	31
5.1 System Description	31
5.2 Factory Backup and Service Assistance	31
6.0 EQUIPMENT INSPECTION AND STARTUP	32
6.1 Exterior Inspection	32
6.2 Internal Inspection	32
6.3 Startup	32
6.4 Current Monitoring Panel (Optional)	33
6.5 Current Plus Monitoring™ (Optional)	34
6.6 Liebert LDMF™—Optional	34
6.7 Liebert LDMF Display—Optional	34
7.0 OPERATING INSTRUCTIONS	35
7.1 Startup Procedures	35
7.1.1 Normal System Turn On	35
7.2 Normal System Shutdown	35
7.3 Current Monitoring Panel (Optional)	35
7.4 Current Plus Monitoring (Optional)	35
7.5 Liebert LDMF™ (Optional)	36

8.0	MAINTENANCE	37
8.1	Inspection and Cleaning	37
8.2	Inspection Schedule	37
8.3	Proper Tightening of Nuts and Bolts	37
9.0	SPECIFICATIONS	38
9.1	Frequency	38
9.2	Input/Output Voltage	38
9.3	System Current Ratings	38
9.4	Environmental Requirements	38
9.5	Frame and Enclosure	38
9.6	Casters and Leveling	39
9.7	Cooling	39
9.8	Access	39
9.9	Cable Access	39
9.10	Doors	39
9.11	Main Panelboard Circuit Breaker	39
9.12	Distribution Panelboards	39
9.13	Monitoring	40
9.14	Options	40
9.14.1	Current Monitoring Panel	40
9.14.2	Current Plus Monitoring	40
9.14.3	EZ-View Doors	40
9.14.4	Solid Sheet Metal Doors	40
9.14.5	Plug-In Main Breakers	40
9.14.6	Maintenance Tie-Breakers	40
9.14.7	Isolated Ground Busbar	40
9.14.8	65kAIC Main Panelboard Circuit Breaker (380-480V, 60Hz, units)	40
9.14.9	Liebert LDMF™	41
9.14.10	Side Panels	41
9.14.11	Export Crating	41
9.14.12	Seismic Floor Stands	41
9.14.13	65kAIC Main Panelboard Circuit Breaker (380-480V, 60Hz, units)	41

FIGURES

Figure 1	Typical bottom exit cabinet and floor planning dimension data	4
Figure 2	Typical tie-breaker bottom exit cabinet and floor planning dimension data	5
Figure 3	Typical top exit cabinet and floor planning dimension data	6
Figure 4	Typical 380-480V, 60Hz, cabinet and floor planning dimension data	7
Figure 5	Shipping brackets	9
Figure 6	Recommended minimum service and ventilation clearances	11
Figure 7	Seismic floor stand	13
Figure 8	Electrical field connections, 1 input	15
Figure 9	Electrical field connections, 2 inputs	16
Figure 10	Electrical field connections, 4 inputs	16
Figure 11	Top exit electrical field connections, 1 input	17

Figure 12	Top exit electrical field connections, 2 inputs	18
Figure 13	Top exit electrical field connections, 4 inputs	19
Figure 14	380-480V, 60Hz, electrical field connections	20
Figure 15	Current Plus Monitoring location - bottom exit	22
Figure 16	Current Plus Monitoring™ location - top exit	23
Figure 17	Current Plus Monitoring and Liebert LDMF communication and summary alarm connections	24
Figure 18	Control connections for Liebert LDMF - bottom exit	25
Figure 19	Control connections for Liebert LDMF™ - top exit	26
Figure 20	Control connections for Liebert LDMF™ 380-480V, 60Hz	27
Figure 21	Connections for replacement Current Transformer (CT) for Liebert LDMF™ CT sensor module	28
Figure 22	Connections to Liebert LDMF™ SiteScan® monitoring interface - bottom exit	29
Figure 23	Connections to Liebert LDMF™ SiteScan® monitoring interface - top exit	30
Figure 24	Current Monitoring Panel	33
Figure 25	Current Plus Monitoring panel	34

TABLES

Table 1	Torque tightening	37
Table 2	Input/output voltage	38
Table 3	System current ratings	38

IMPORTANT SAFETY INSTRUCTIONS

SAVE THESE INSTRUCTIONS

This manual contains important instructions that should be followed during the installation and maintenance of the Liebert FDC. Read the entire manual before installing or operating the system. Adhere to all operating instructions and warnings on the unit and in this manual.

WARNING

The unit contains hazardous voltages when input source is on. To isolate the unit, turn Off and lock out the input power source.

Verify that the input power source is de-energized and locked out before installing cables or making connections in the unit.

Lethal voltages exist inside the unit during normal operation. Only qualified service personnel should perform maintenance on the Liebert FDC.

NOTE

Vertiv neither recommends nor knowingly sells this product for use with life support or other FDA-designated “critical” devices.

The Liebert FDC is suitable for indoor use only. Protect the unit from excessive moisture and install the unit in an area free from flammable liquids, gases and corrosive substances.

Provide input overcurrent protection in accordance with the unit ratings. Wire and ground the unit according to national and local electrical safety codes. All wiring should be installed by a qualified electrician.

Before the unit is placed into service for the first time, as well as after equipment relocation and after the unit has been de-energized for an extended period of time, thorough equipment inspection and supervised startup by qualified service personnel are strongly recommended.

CAUTION

This unit complies with the limits for a Class A digital device, pursuant to Part 15 Subpart J of the FCC rules. These limits provide reasonable protection against harmful interference in a commercial environment. This unit generates, uses and radiates radio frequency energy and, if not installed and used in accordance with this instruction manual, may cause harmful interference to radio communications. Operation of this unit in a residential area may cause harmful interference that users must correct at their own expense.

WARNING

Locate the center of gravity symbols  and determine the unit’s weight before handling the cabinet.

WARNING

The shipping bands may be under tension. Use appropriate eye, face and hand protection to safeguard against injury from band backlash.

NOTE

The unit should NOT be loosened from the shipping pallet until all handling by forklift or pallet jack is completed.

1.0 SAFETY PRECAUTIONS

Read this manual thoroughly before working with the Liebert FDC.

Be sure to review the warnings under **IMPORTANT SAFETY INSTRUCTIONS on page 1**.

Refer to **2.2.1 - Handling Considerations** before attempting to move the unit.

Under typical operation and with the doors closed, only normal safety precautions are necessary. The area around the Liebert FDC should be kept free from puddles of water, excess moisture and debris. The areas in front and to the rear of the unit should be kept unobstructed to ensure a smooth airflow through the unit for cooling.

ONLY qualified service personnel should perform maintenance on the Liebert FDC. When performing maintenance on any part of the equipment under power, service personnel and test equipment should be located on rubber mats. The service personnel should wear insulating shoes for isolation from direct contact with the floor.

Unless all power is removed from the input source to the unit, one person should never work alone. A second person should be on hand to assist and summon help, should an accident occur.

2.0 UNPACKING AND INSPECTIONS



NOTE

Read the entire manual before installing and operating the unit. Upon receipt of the Liebert FDC, the installer should perform the following steps to ensure a high-quality installation.

A high-quality installation begins on the receiving dock. The Liebert FDC and its packaging should be inspected when the unit is delivered. If the packaging is not damaged, unpack the unit and conduct an internal inspection before beginning the installation process. This section discusses unpacking and inspecting the Liebert FDC.

2.1 External Inspections

1. Upon receipt and before unpacking, inspect the equipment and shipping material for any signs of damage or mishandling. Do not attempt to install the system if damage is apparent.
2. Check the Shock-Watch™ indicator.
 - If the indicator is red, note this on the shipper's receipt and check for concealed damage.
 - If any damage as a result of shipping is observed, file a damage claim with the shipper within 24 hours and contact your local Vertiv representative or Vertiv Technical Support at 800-543-2378 to report the damage claim and the condition of the equipment.
3. Locate the bag containing the keys for the front and rear doors. The bag is attached to the cabinet.
4. Compare the contents of the shipment with the bill of lading. Report any missing items to the carrier and to Vertiv Technical Support immediately.
5. Check the nameplate on the cabinets to verify that the model numbers correspond with the ones specified. Record the model number and serial number above under Support Information. A record of this information is necessary should servicing be required.
6. If installation will be delayed, Vertiv recommends storing the unit in a dry environment with temperatures in the range of -67°F to 185°F (-55°C to 85°C). Use the original packing materials or other suitable means to keep the unit clean. When removing the shipping material, use care not to puncture the equipment.

If any damage as a result of shipping is observed, immediately file a damage claim with the shipping agency and forward a copy to:

Vertiv
1050 Dearborn Drive
P.O. Box 29186
Columbus, Ohio 43229 USA

2.2 Handling and Unloading

2.2.1 Handling Considerations

The Liebert FDC is bolted to a wooden pallet to allow handling by a forklift, pallet jack or similar equipment.

- **Check size and weight**—Refer to the outline drawings furnished with the unit for size and weight information. Typical cabinet dimensions and weights are shown in **Figures 1 and 2**.
- **Plan the route**—The route to the unit's installation area should be planned to ensure that all passages are large enough to accommodate the unit and that the floors are strong enough to support the weight. Check all doorways, hallways elevators, ramps and other portions of the route to determine if there are any obstructions and to ensure each is large enough and strong enough to allow passage.
- **Move with care**—The Liebert FDC should be moved to the installation area on the wooden pallet using forklift or pallet jack.
- **Casters for movement**—The unit is furnished with integral casters that allow the unit to be rolled into place after it has reached its location and is removed from the pallet.

Figure 1 Typical bottom exit cabinet and floor planning dimension data

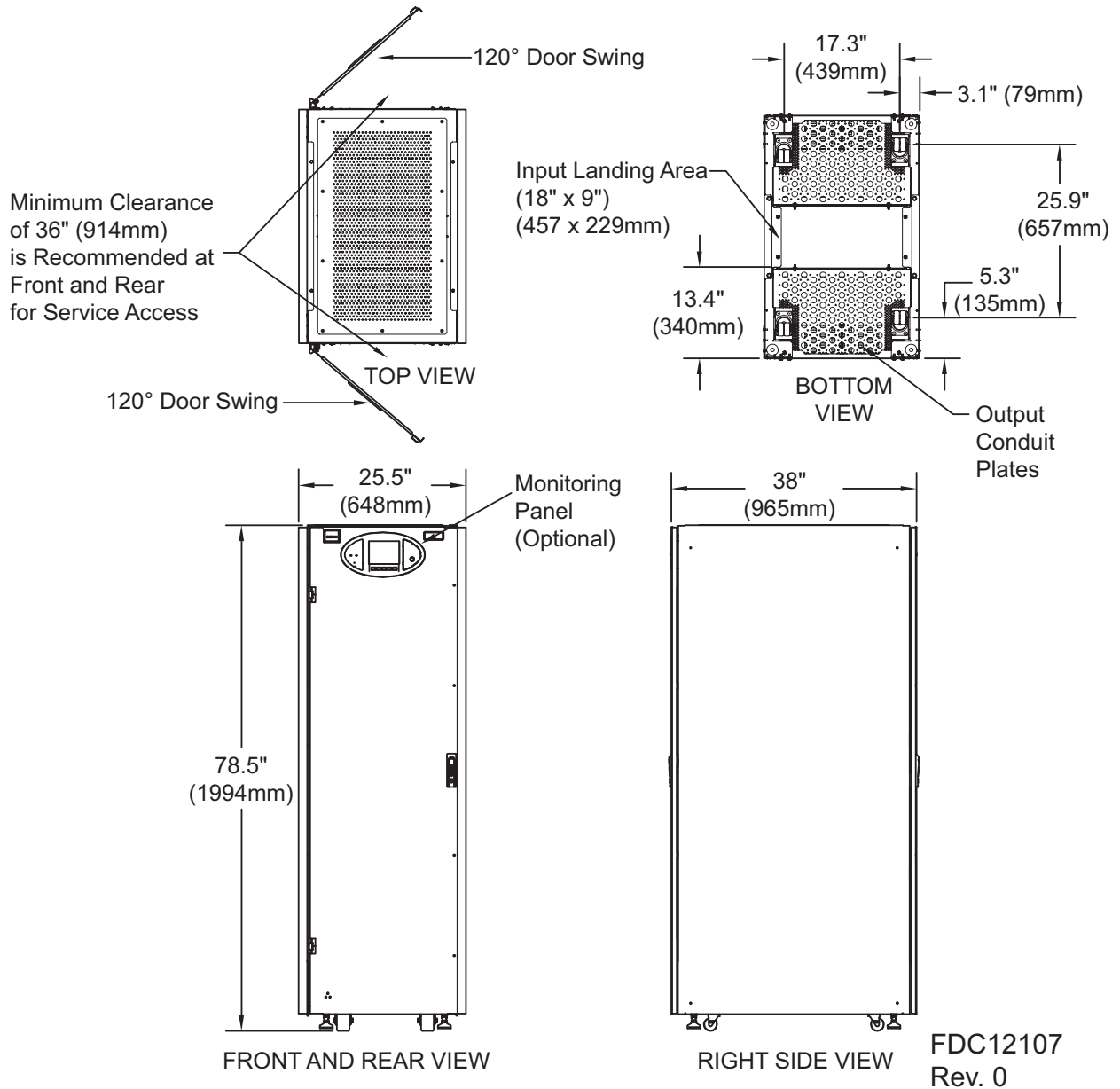

FDC12107
Rev. 0

NOTES

1. Weight: 750 lb. (340kg)
2. Heat Output: 3412 BTU/Hr (1kW)
3. Casters are removable
Height without casters: 77 in. (1956mm)

Figure 2 Typical tie-breaker bottom exit cabinet and floor planning dimension data

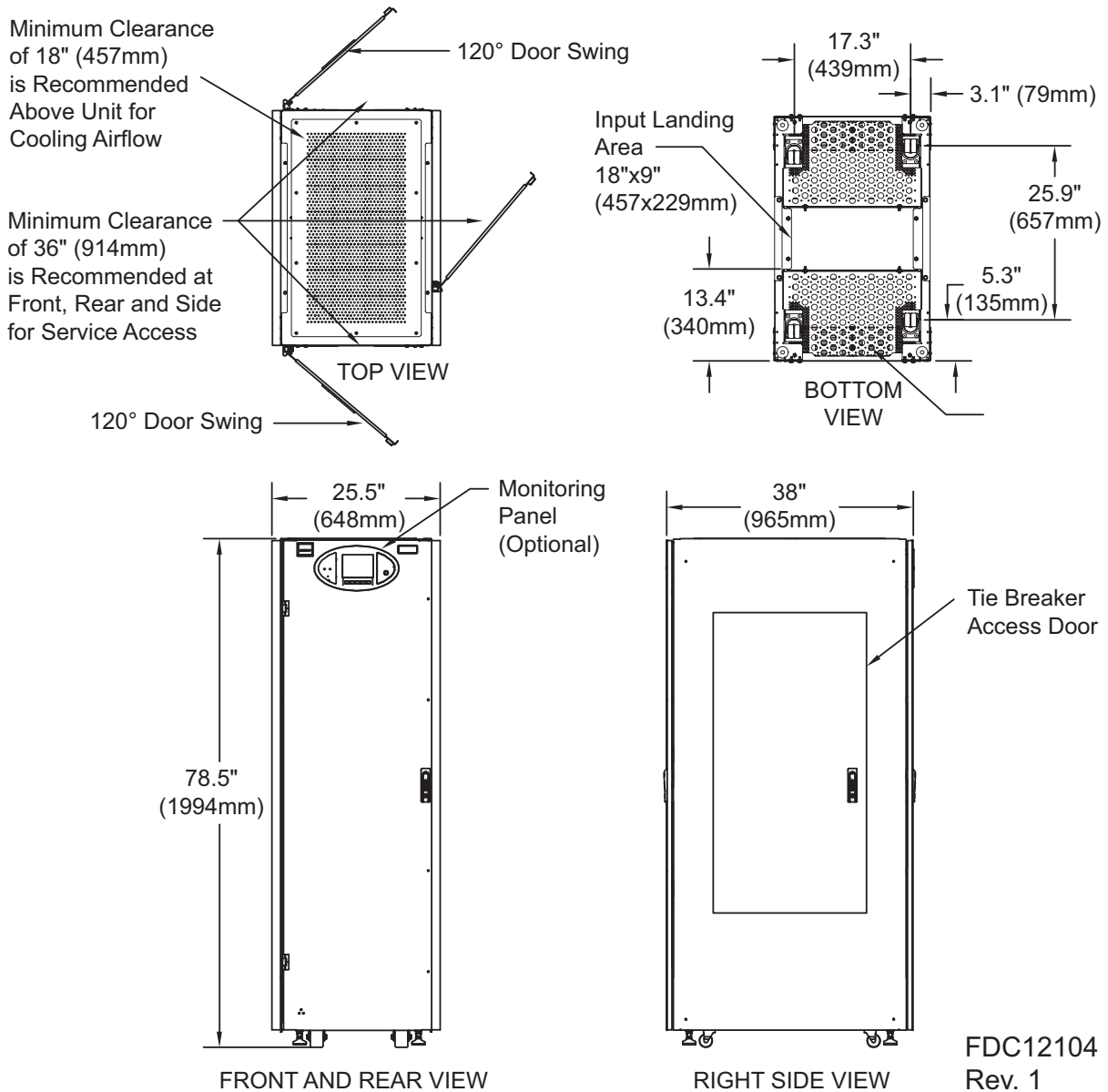

FDC12104
Rev. 1

NOTES

1. Weight: 750 lb. (340kg)
2. Heat Output: 3412 BTU/Hr (1kW)
3. Casters are removable
Height without casters: 77 in. (1956mm)

Figure 3 Typical top exit cabinet and floor planning dimension data

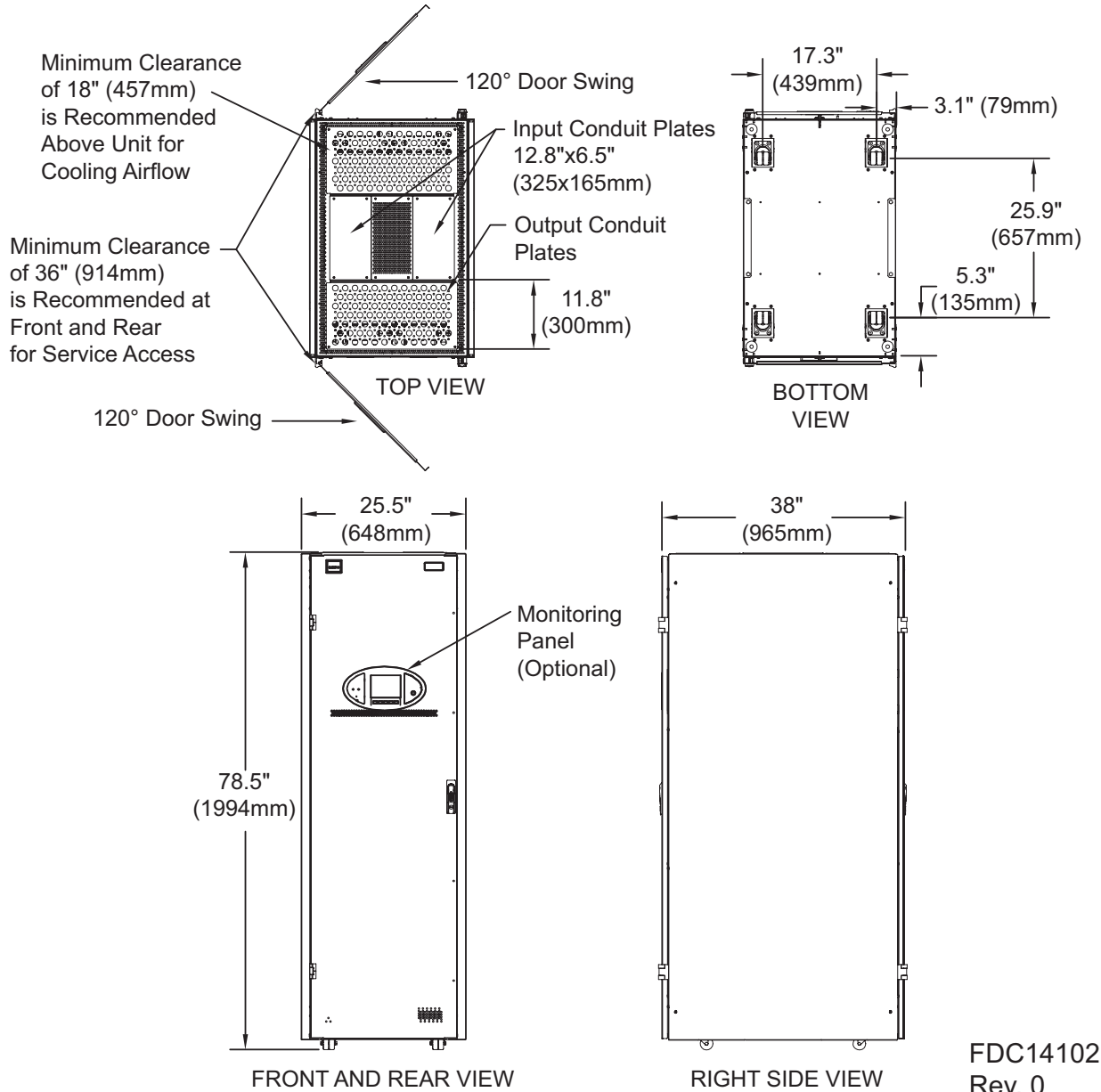

FDC14102
Rev. 0

NOTES

1. Weight: 750 lb. (340kg)
2. Heat Output: 3412 BTU/Hr (1kW)
3. Casters are removable
Height without casters: 77 in.

Figure 4 Typical 380-480V, 60Hz, cabinet and floor planning dimension data

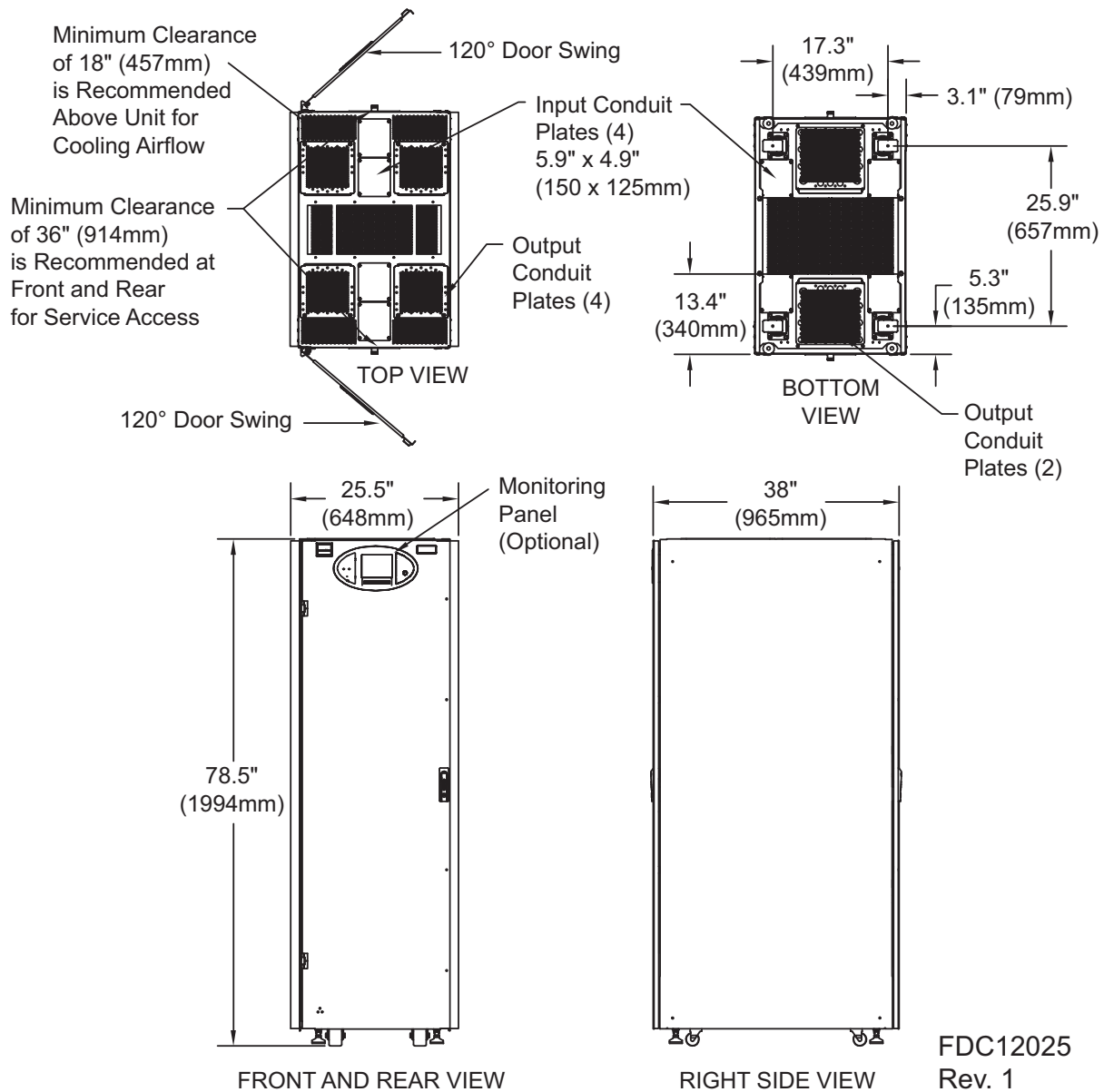

NOTES

1. Weight: 750 lb. (340kg)
2. Heat Output: 3412 BTU/Hr (1kW)
3. Casters are removable
Height without casters: 77 in.

2.2.2 Unloading the Unit from the Pallet

The Liebert FDC may be easily removed from the shipping pallet and installed by customer personnel. A typical procedure is:

1. Move the unit on the shipping pallet as close to the final location as possible.



WARNING

Exercise extreme care when handling the Liebert FDC to avoid equipment damage or injury to personnel.

Risk of unit damage. Do not exceed a 15-degree tilt with the forklift.

2. Set the shipping pallet in a level area where there is enough room to roll the Liebert FDC off the pallet onto the floor.
3. Cut the shipping bands.



WARNING

The shipping bands may be under tension. Use appropriate eye, face and hand protection to safeguard against injury from band backlash.

4. Remove the factory-provided ramp from its shipping position. One ramp is provided per order, packed either in front or to the rear of the unit. Place the ramp adjacent to the pallet to provide a smooth path from pallet to floor.
5. Remove the packing material and inspect the equipment for any obvious shipping damage. Use care to avoid puncturing the packing material. Make sure cardboard is removed from the top of the unit.
6. If the unit is supplied with side panels, remove side panels.
7. Remove the two shipping brackets used to hold the unit to the shipping pallet. The brackets are located on each side of the unit, as shown in **Figure 5**. Remove the three bolts that attach the bracket to the pallet, then remove the two bolts located under the frame that attach the bracket to the unit. Brackets and bolts should be saved in case the unit is relocated in the future.
8. Remove the shipping blocks from under the unit frame by extending the leveling feet or using a forklift to raise the unit off the blocks. Ensure that the forklift is clear of the unit's caster and leveling feet. Lift the unit from the side. Raise the leveling feet (if lowered).
9. Roll the unit off the pallet onto the floor.
10. Reattach the side panels if supplied
11. Roll the unit to the location of installation. If placing the unit on a raised floor, use care when positioning the unit over the floor cutout to prevent casters from falling through the cutout.

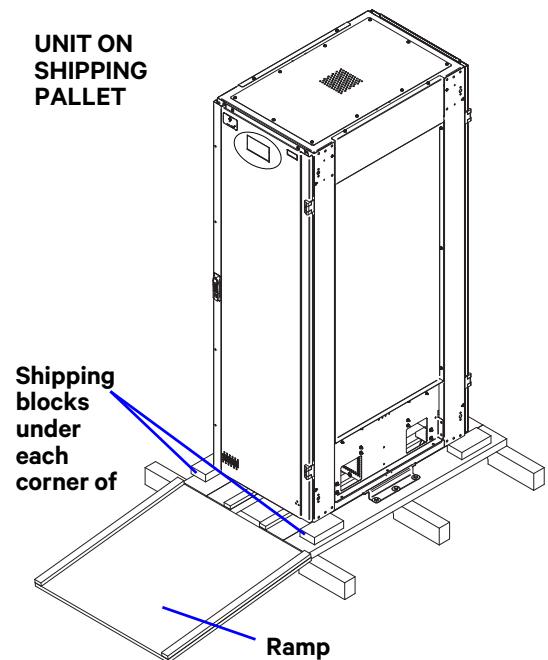

WARNING

If moving the unit up a ramp on its casters or a pallet jack, ensure that the incline does not exceed 15 degrees. Locate the center of gravity symbols and determine the unit's weight before handling the cabinet.

If you are moving the unit by forklift or pallet jack after it has been removed from the pallet, be aware of the location of the casters and leveling feet so as not to damage them.

Before maneuvering the unit into its final position, read and follow all advisories in **3.0 - LOCATING THE LIEBERT FDC**.

Figure 5 Shipping brackets

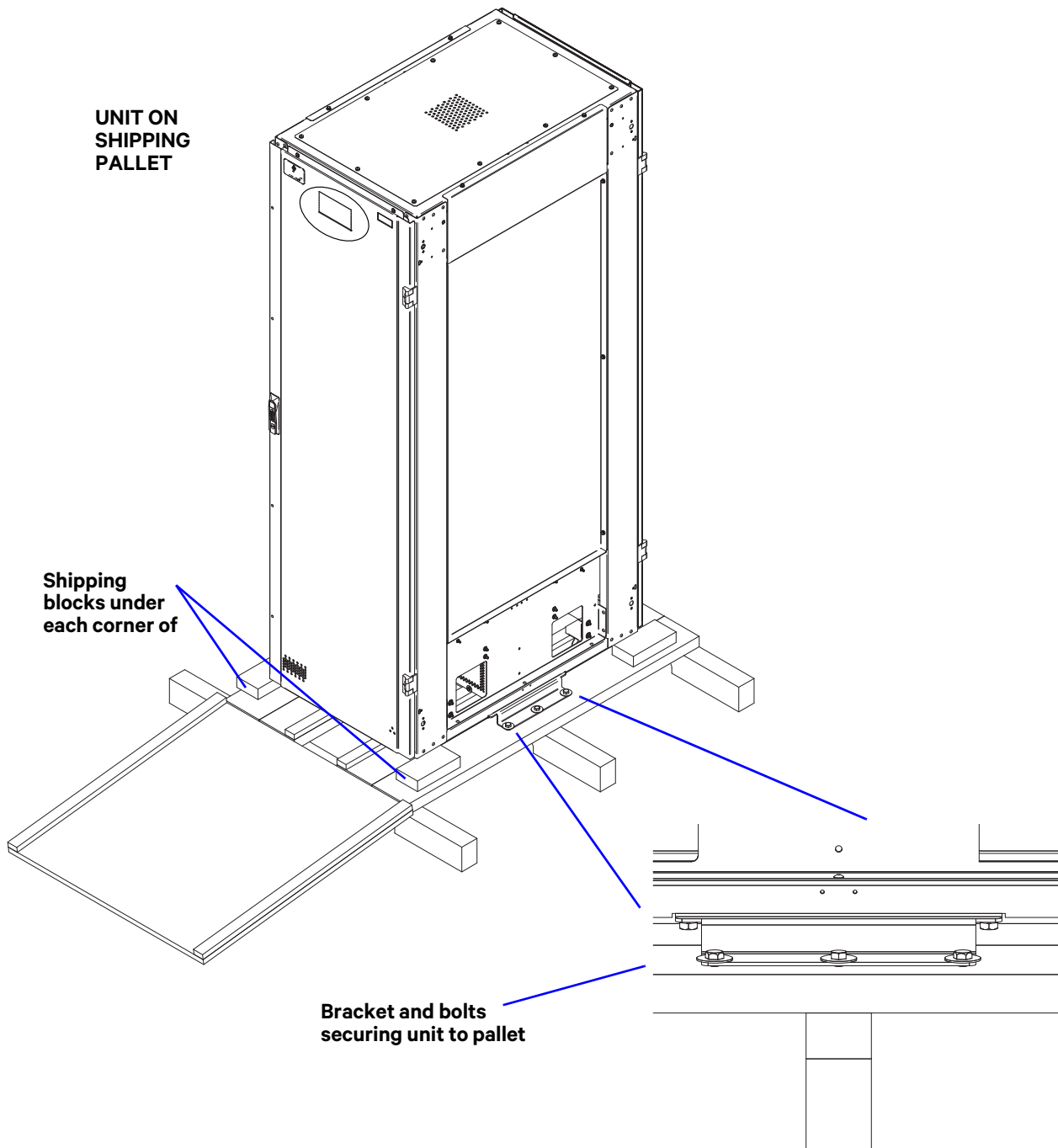

2.3 Internal Inspections

After the Liebert FDC has been unpacked, conduct an internal inspection:

1. Verify that all items have been received.
2. Open the doors and panelboard accent panels and remove the side panels to check for shipping damage to internal components.
3. Check for loose connections or unsecured components in the cabinet.
4. Check for any unsafe condition that may be a potential safety hazard.

After the Liebert FDC has been inspected and no problems are found, the unit can be moved to its installation location. If using a forklift, remember to lift the unit from the side. Ensure that the forklift is clear of the unit's casters and leveling feet.

3.0 LOCATING THE LIEBERT FDC

3.1 Location Considerations

The Liebert FDC should be installed in a clean, cool and dry location. The unit should be located within the data center and/or close to any loads that it is supplying. The Liebert FDC requires front and rear access for installation and maintenance. Units with optional Maintenance Tie-Breakers require front, rear and right-side access. If bottom cable exit is used, sufficient cable bending space must be provided by a raised floor.

Equipment Location—Employ the shortest output distribution cable runs consistent with logical equipment arrangement and allowances for future additions.

Units with bottom cable/conduit exit require bottom clearance for entry and exit of cables/conduits and for air intake. This clearance is automatically provided by a raised floor with a minimum height of 12 in. (305mm).

Clearance—Minimum of 18 in. (457mm) clearance above the unit is required for cooling air exhaust.

Units with top cable/conduit exit require top clearance for entry and exit of cables/conduits and for cooling air exhaust.

3.1.1 Recommended Minimum Service Clearances

Recommended minimum service clearances are shown in **Figure 6**. The indicated clearances at the front and rear of the unit are required by the National Electrical Code (NEC) for service access. If optional Maintenance Tie-Breakers are supplied, right-side access is also required by the NEC for service access.

Figure 6 Recommended minimum service and ventilation clearances

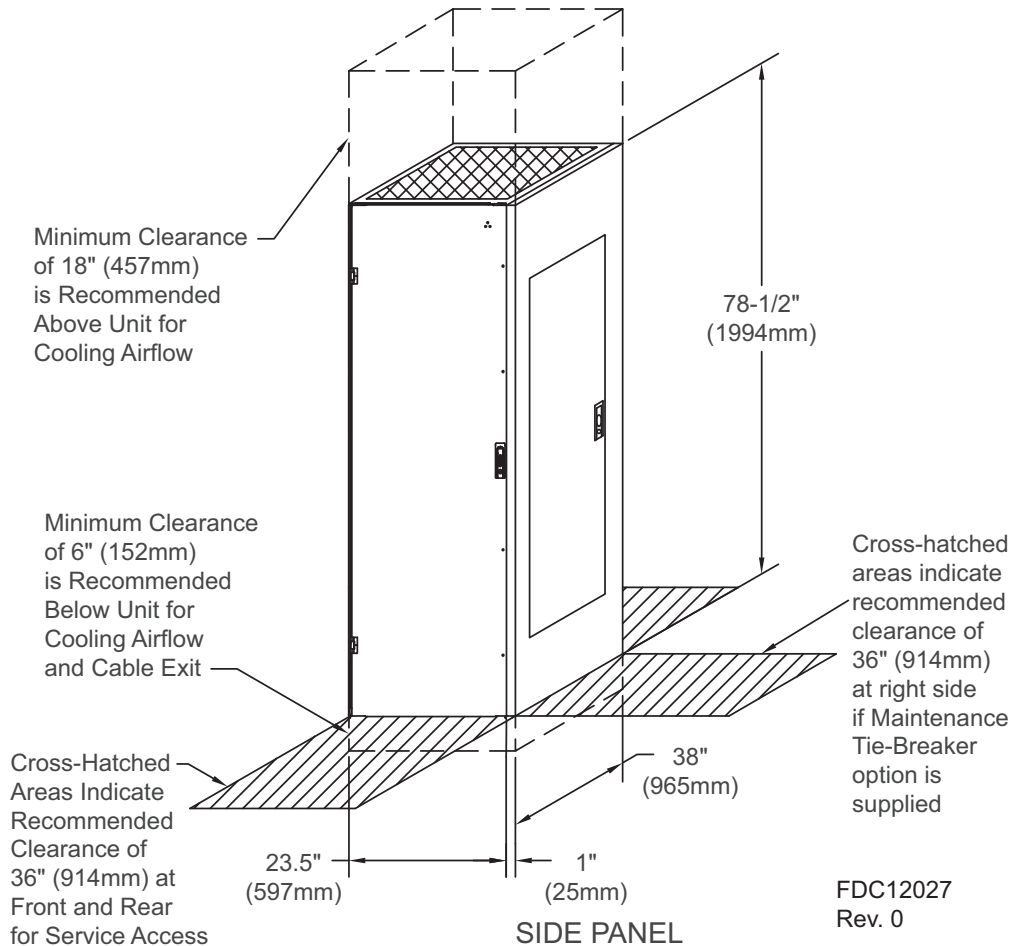

3.1.2 Heat Output

As with all electrical devices, the Liebert FDC produces heat under normal operation. The maximum heat output is 3412 BTU/hr (1 kW). This heat output should be included when calculating the environmental conditions of the room.

3.1.3 Operating Environment

The unit is designed to be installed indoors where the ambient air temperature is in the range of 32°F to 104°F (0°C to 40°C) with a relative humidity of 0% to 95% (non-condensing).

Operating altitude up to 6,600 ft. (2000m) above Mean Sea Level.

Audible noise under normal operation shall not exceed 45dBA measured 5 ft. (1.5m) from the surface of the Liebert FDC.

3.2 Final Positioning of the Liebert FDC

Set the Liebert FDC in final position. The Liebert FDC is furnished with casters and leveling feet. After final positioning of the unit, adjust the leveling feet, located in each corner of the frame base, to level and stabilize the unit. For additional stability, the Liebert FDC should be bolted to the floor.

3.2.1 Seismic Floor Stand (Optional)

1. Unpack the floor stand from the pallet and place in its final position. Adjust the leveling feet, located in each corner of the floor stand base, to level and stabilize the floor stand.
2. To adjust the height of the feet, loosen the top nut and adjust the bottom nut to desired height. Tighten the top nut and jam nut to specified torque (shown in detail A and B in **Figure 7**).
3. Use 1/2" red head concrete anchors to mount the floor stand to a concrete surface (supplied by customer).
4. Disassemble mounting brackets from the floor stand. Roll the Liebert FDC onto the floor stand or use a forklift to raise the unit off the floor and onto the floor stand. Ensure that the forklift is clear of the unit's caster and leveling feet. Lift the unit from the side.
5. Align the Liebert FDC on top of the floor stand and then reinstall mounting brackets (see detail C in **Figure 7**).
6. Check all hardware for proper torque prior to installation. Reference hardware torque chart in **Figure 7**.

Figure 7 Seismic floor stand

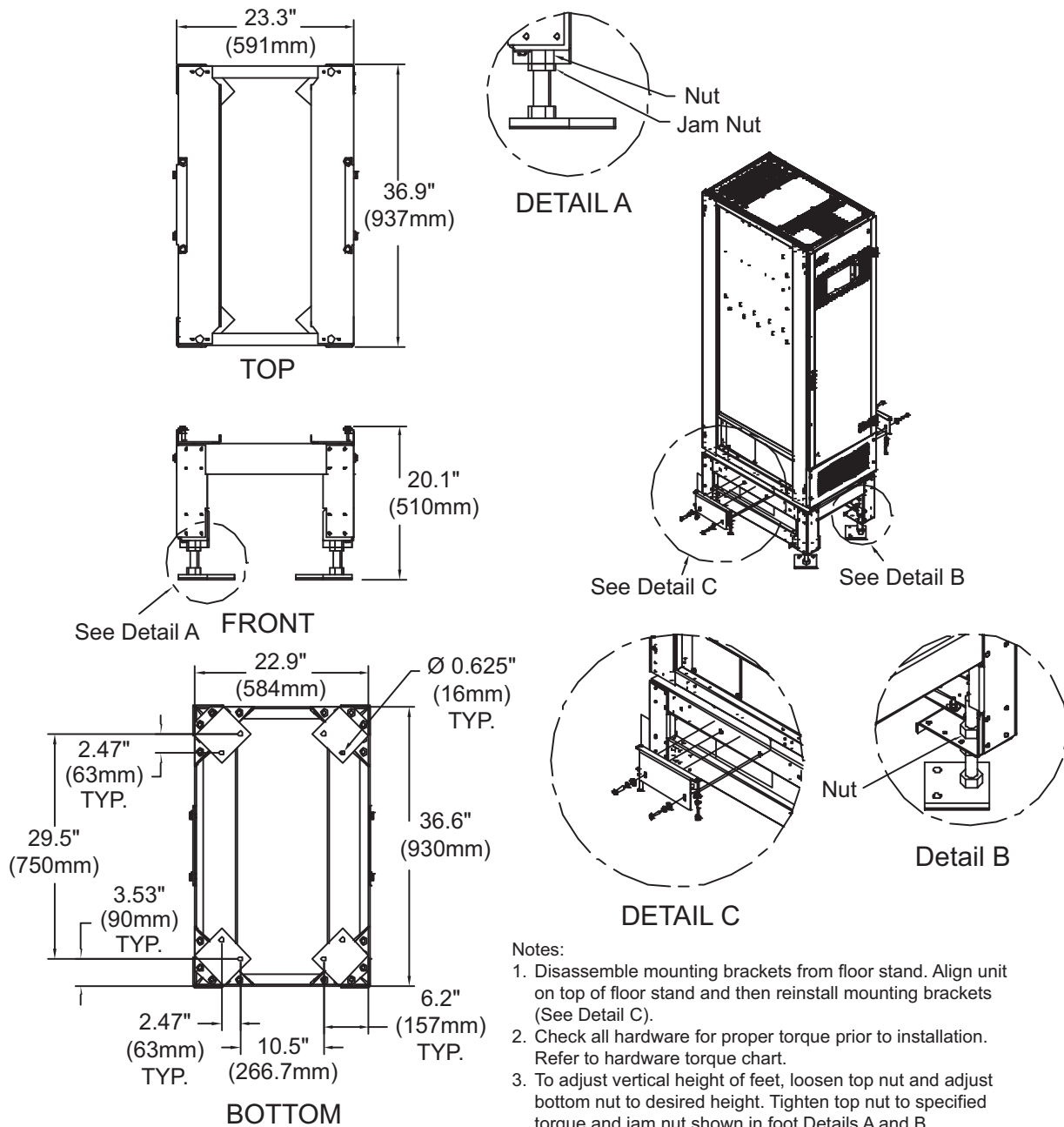

Notes:

1. Disassemble mounting brackets from floor stand. Align unit on top of floor stand and then reinstall mounting brackets (See Detail C).
2. Check all hardware for proper torque prior to installation. Refer to hardware torque chart.
3. To adjust vertical height of feet, loosen top nut and adjust bottom nut to desired height. Tighten top nut to specified torque and jam nut shown in foot Details A and B.
4. 1/2" red head concrete anchors that mount floor stand to concrete surface must be supplied by the customer.

FPC17000
Rev. 1

HARDWARE TORQUE	
1.0" NUT	320 FT-LB
M8-1.25	16 FT-LB
M10-1.5	31 FT-LB
M12-1.75	53 FT-LB

HEIGHT TABLE		
HEIGHT RATING	HEIGHT, MAX	HEIGHT, MIN
18.0"	19.25"	16.75"
24.0"	25.25"	22.75"
30.0"	31.25"	28.75"
36.0"	37.25"	34.75"

4.0 POWER AND CONTROL WIRING

A qualified electrician should install all power and control wiring. All power and control wiring must comply with the NEC and applicable local codes. Unless otherwise labeled, use the recommended tightening torque as shown in **Table 1**.

Cables can be installed through the top on top entry/exit units or through the bottom on bottom entry/exit through removable conduit plates. See **Figures 1, 3** and **4** for wiring entrance locations.

The input power connections are made to the power blocks and/or busbars provided inside the unit. These power blocks/busbars are accessible through the front and rear of the unit. Output power connections are made to the panelboard breakers, ground and neutral busbars. The ground and neutral busbars are accessible through the front and rear of the unit. See **Figures 8** through **14** for details on the busbars.



WARNING

Verify that all incoming line voltage (power) circuits are de-energized and locked out before installing cables or making connections in the unit.

4.1 Input Power Connections

1. Remove the front and rear doors and the right side external panel, if supplied.
2. For bottom cable exit units:
 - a. Remove the internal side panel, if side access is available, and panelboard accent panels.
 - b. Remove the front and rear lower accent plates.
3. For top cable exit units, remove the panelboard accent panels.
4. Remove the front and rear clear Plexiglas input power terminal block and busbar covers.
5. Remove front and rear output conduit plates.
6. Remove input conduit tray and punch to match number and size of input conduit(s).
7. Replace input conduit tray and attach input conduit(s).
8. Connect input power cables to the input terminal blocks and/or busbars located in the bottom for bottom cable exit unit or top for top cable exit unit. (See **Figures 8** through **14** and the electrical field connection drawing supplied with the unit for details.)

To minimize disturbances caused by other loads in the building, the 3-phase power input to the unit should be supplied directly from a dedicated power source.

The input feeder circuit should be sized in accordance with the NEC and any local building codes to ensure the feeder's ability to safely carry the system's full load current, including losses.

Input feeder conductors should be sized for no more than 2% voltage drop. If operation at undervoltage conditions for extended periods of time is desired, the input feeders must be oversized.

The main input feeder must consist of 3-phase conductors and one neutral and one (safety) ground conductor (4W + G). If the unit has optional isolated ground busbars, then an isolated ground must be supplied with the input feeder.

Figure 8 Electrical field connections, 1 input

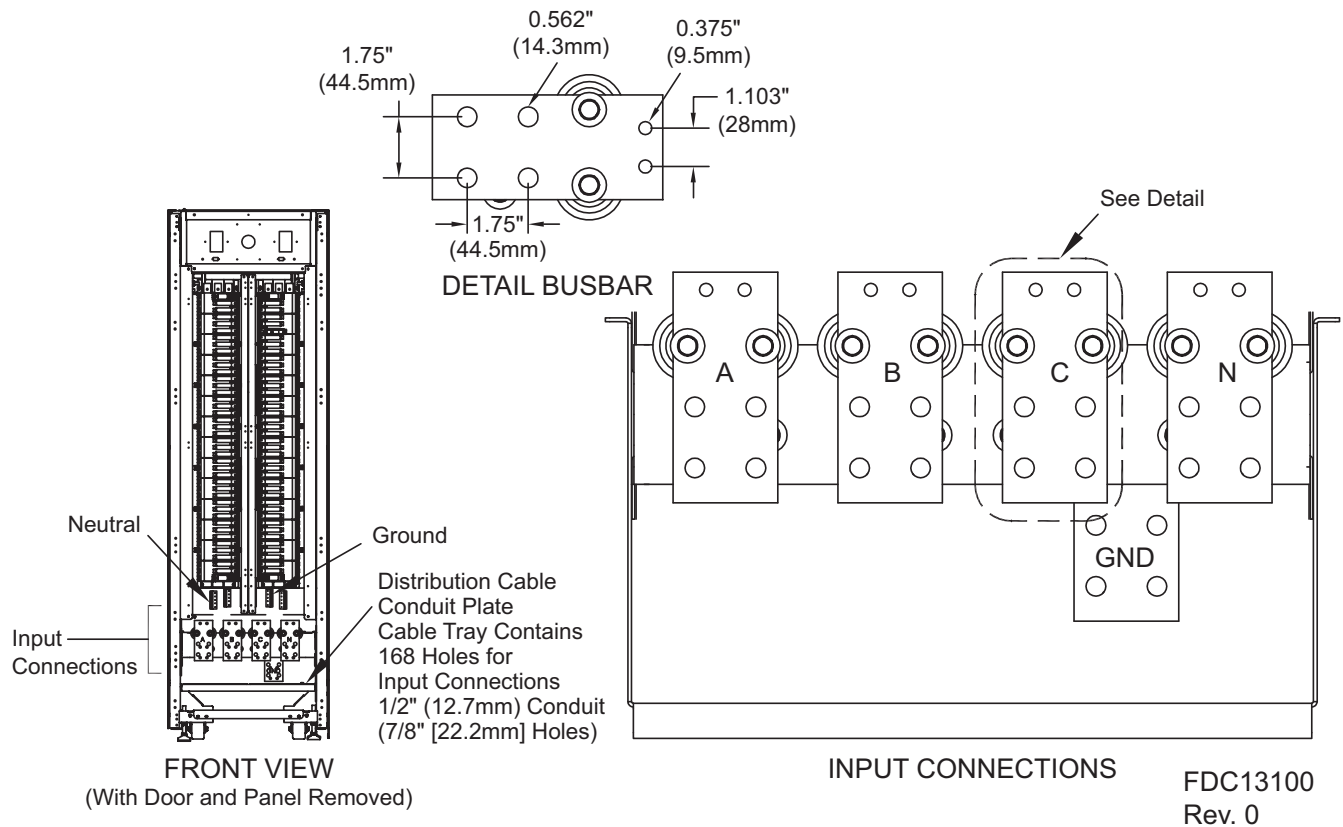

Figure 9 Electrical field connections, 2 inputs

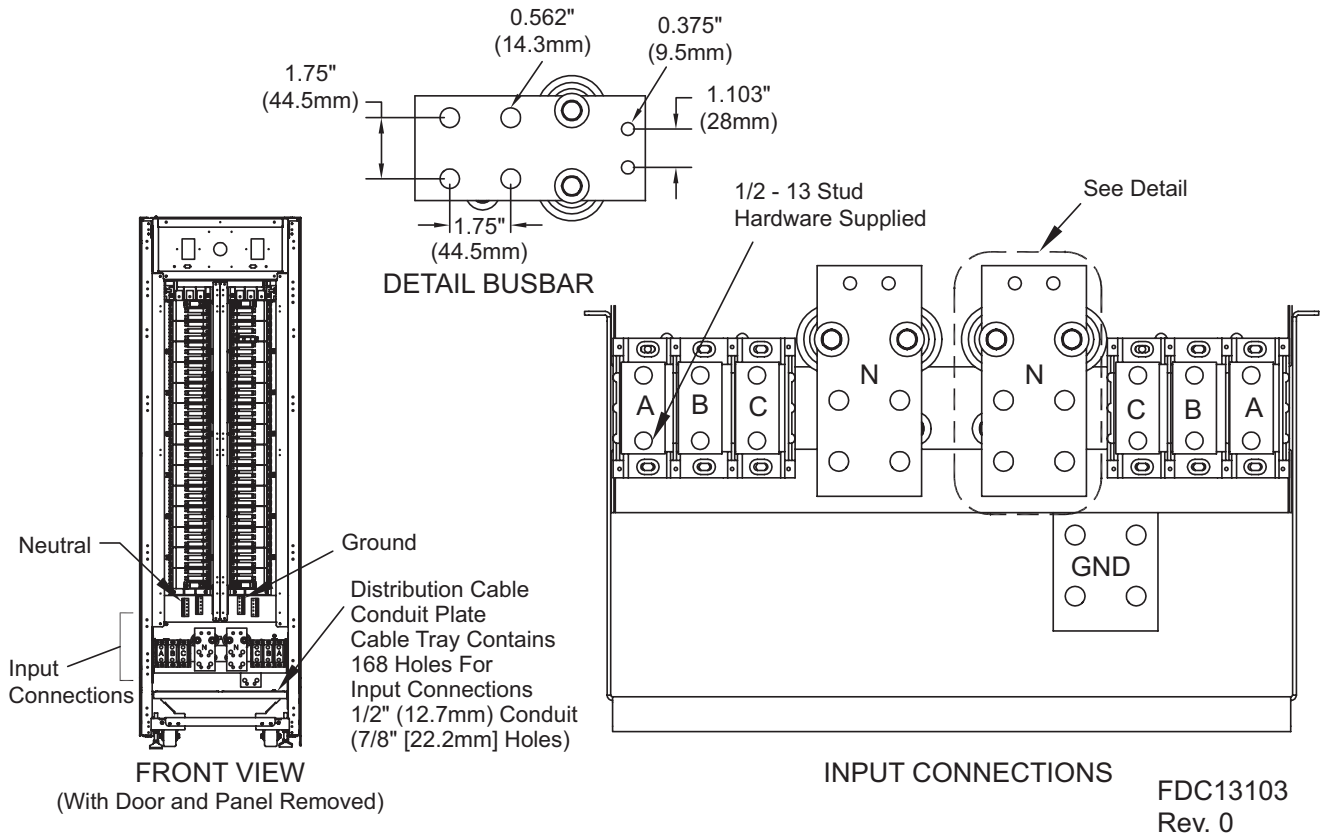

Figure 10 Electrical field connections, 4 inputs

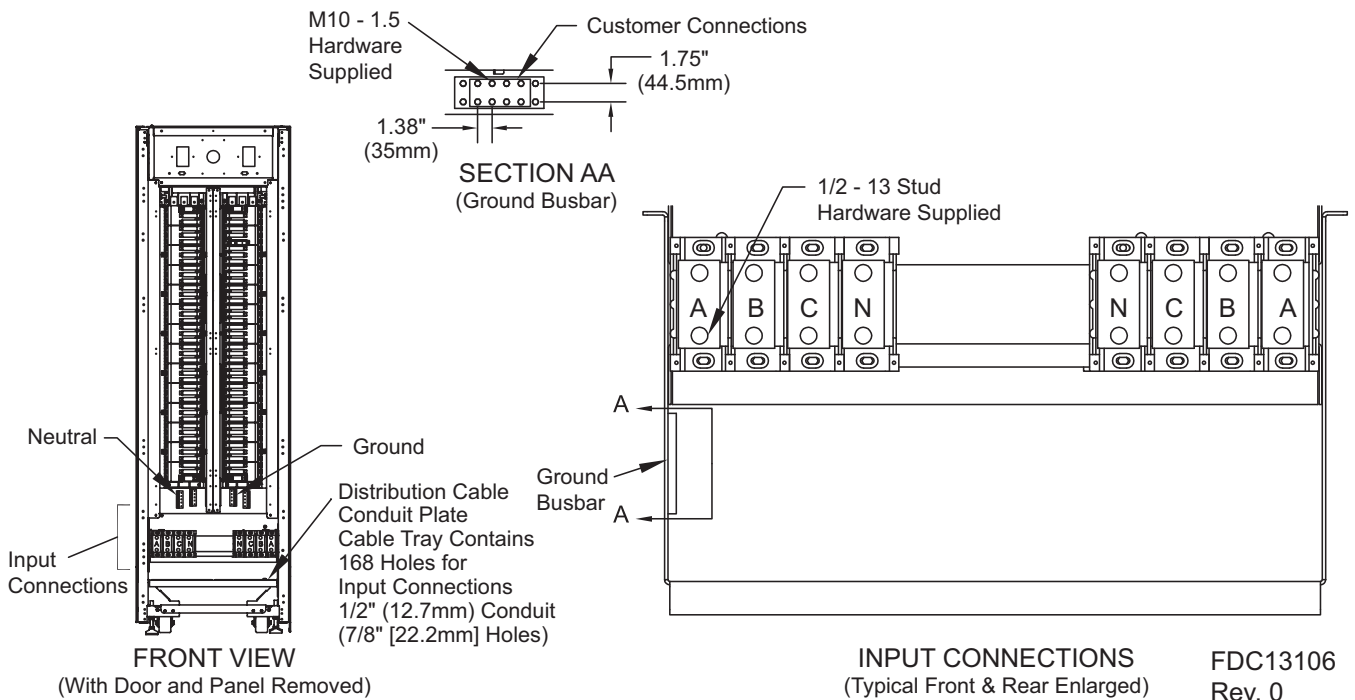

Figure 11 Top exit electrical field connections, 1 input

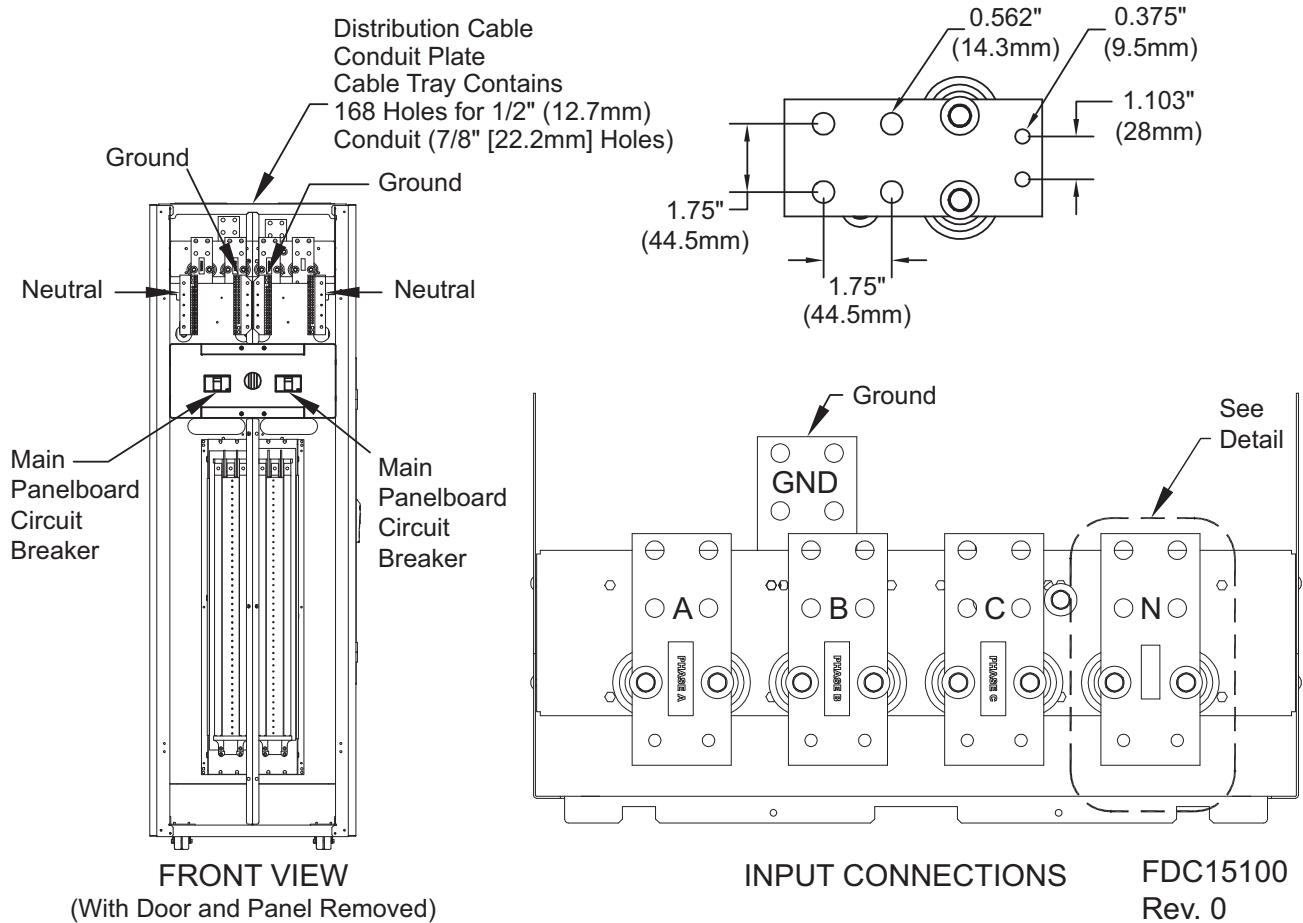

Figure 12 Top exit electrical field connections, 2 inputs

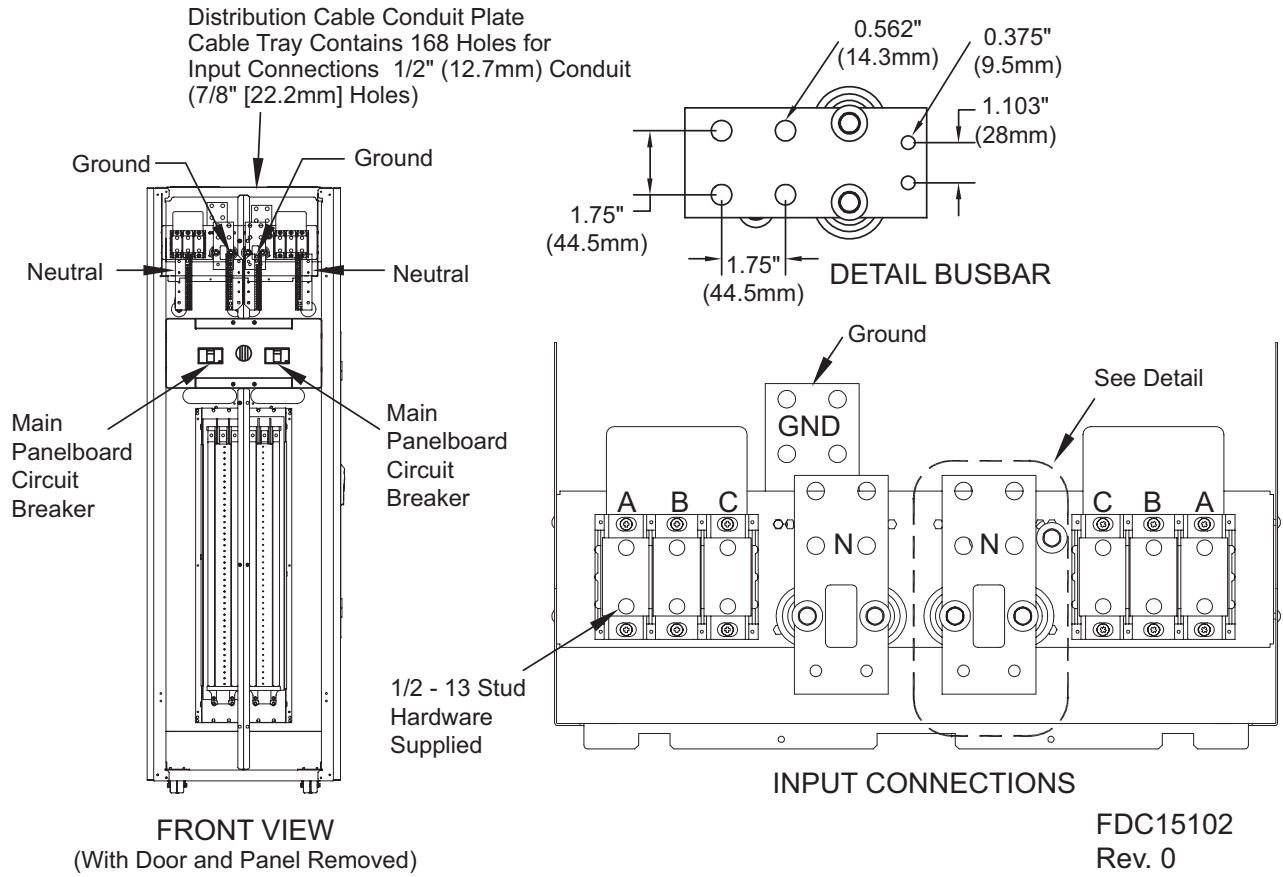

Figure 13 Top exit electrical field connections, 4 inputs

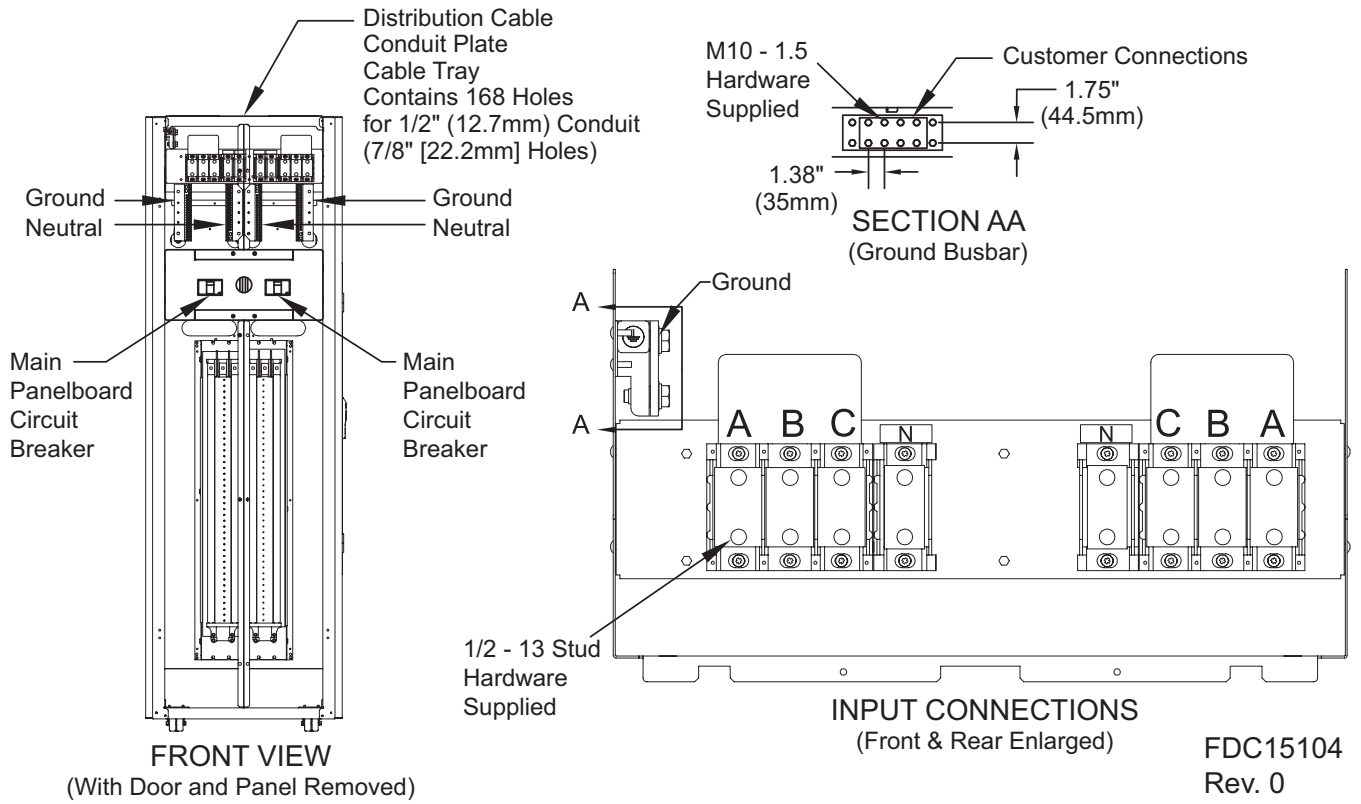
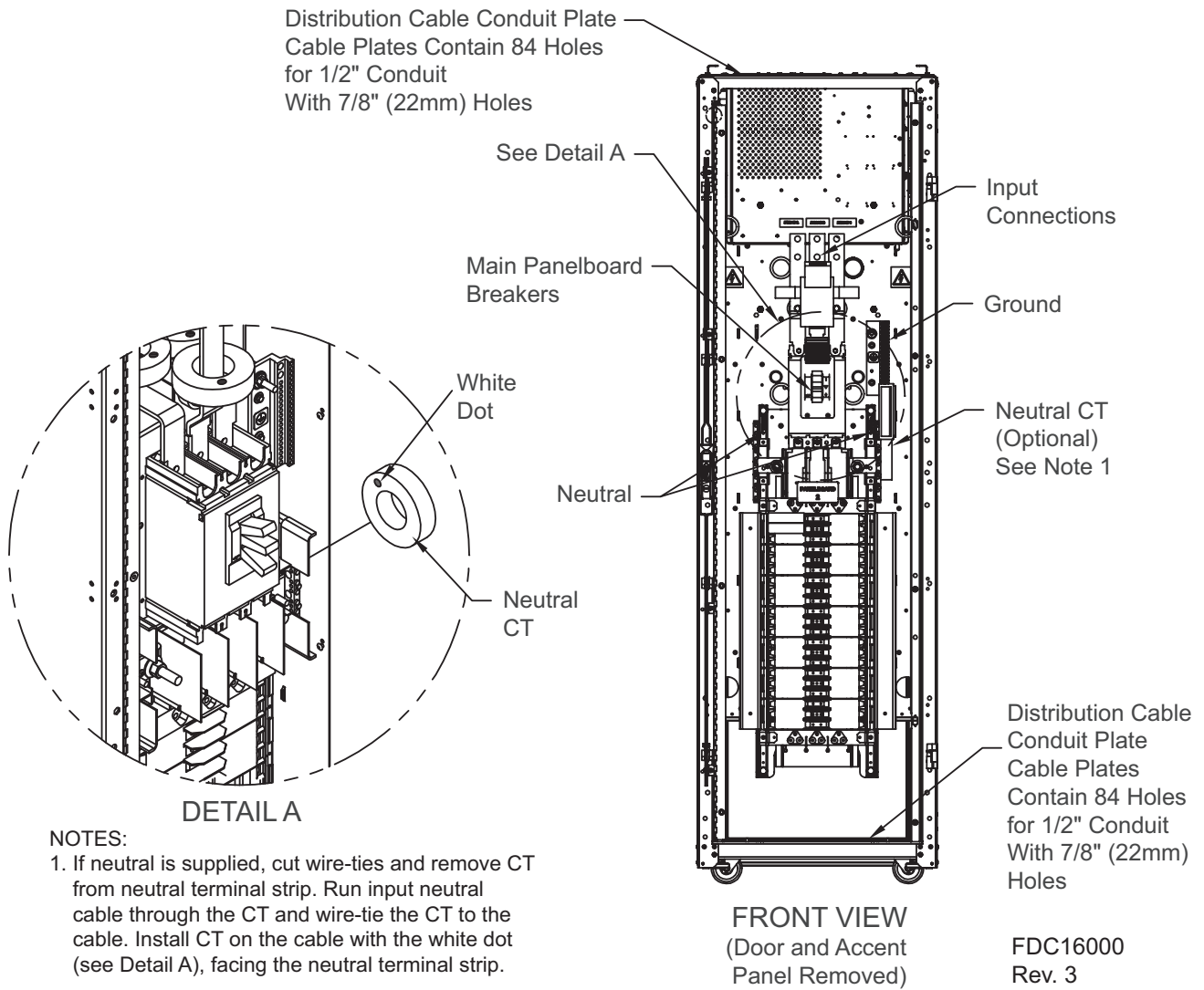

Figure 14 380-480V, 60Hz, electrical field connections



NOTES:

1. If neutral is supplied, cut wire-ties and remove CT from neutral terminal strip. Run input neutral cable through the CT and wire-tie the CT to the cable. Install CT on the cable with the white dot (see Detail A), facing the neutral terminal strip.

4.2 System Grounding

Equipment grounding - Grounding is primarily for equipment and personnel safety, although proper grounding also enhances equipment performance.

All input and output power feeds must include an equipment grounding means as required by the NEC and local codes.

An insulated equipment ground conductor is recommended to run with each input and output power feed. The equipment ground conductors should be at least the minimum size conductor per the NEC based on the upstream overcurrent protection device.

Isolated ground - If the unit is supplied with optional output panelboard isolated ground busbars, connect the isolated ground conductor from the load cable to the panelboard isolated ground busbar.

4.3 Output Power Connections

Output panelboards with ground and neutral provisions are provided inside the unit for connecting loads as required (see **Figures 8, 9 and 10**).

Flexible output distribution cables are used in data processing areas under a raised floor. Cable lengths and layout should be well planned:

- Cable routes should follow aisles between equipment. This will facilitate access to cables for installation, routine inspection, and future changes.
- Determine the required cable length by measuring the distance to the load equipment following right-angle paths, rather than diagonally or directly. Always measure to the extreme far side of the equipment with respect to the unit to insure adequate cable length.
- Prevent restriction of airflow under the raised floor by running the flexible conduits flat on the subfloor in parallel paths.
- Balancing of loads across the three phases is good design practice on any 3-phase system.



WARNING

Verify that incoming line voltage circuits are de-energized and locked out before installing output breakers and cables.

- All output cables and connections must comply with the NEC and all other applicable codes.
- All output cables without receptacles that are hard-wired to the load equipment must be equipped with a padlock-off accessory for the output circuit breaker. The padlock-off accessory is used to lock out and tag the circuit breaker while service is performed on the hard-wired load equipment in accordance with OSHA safety rules.

4.4 Control Wiring Connections

No control wiring is needed on the standard Liebert FDC. Only the optional Current Plus Monitoring (CPM) and Liebert Distribution Monitoring™ (LDMF) require external control wiring.

4.4.1 Current Plus Monitoring™ —Optional

If the optional Current Plus Monitoring is supplied, remote communication and Summary Alarm connections are available. Current Plus Monitoring is supplied with three Liebert IntelliSlot™ bays. Three Liebert IntelliSlot cards can be added for customer connection to a Building Management System (BMS). Current Plus Monitoring can communicate to Liebert SiteScan™ using an RS-485 connection on the adapter board.

See **Figures 15** and **17** for location and connection details.

Figure 15 Current Plus Monitoring location - bottom exit

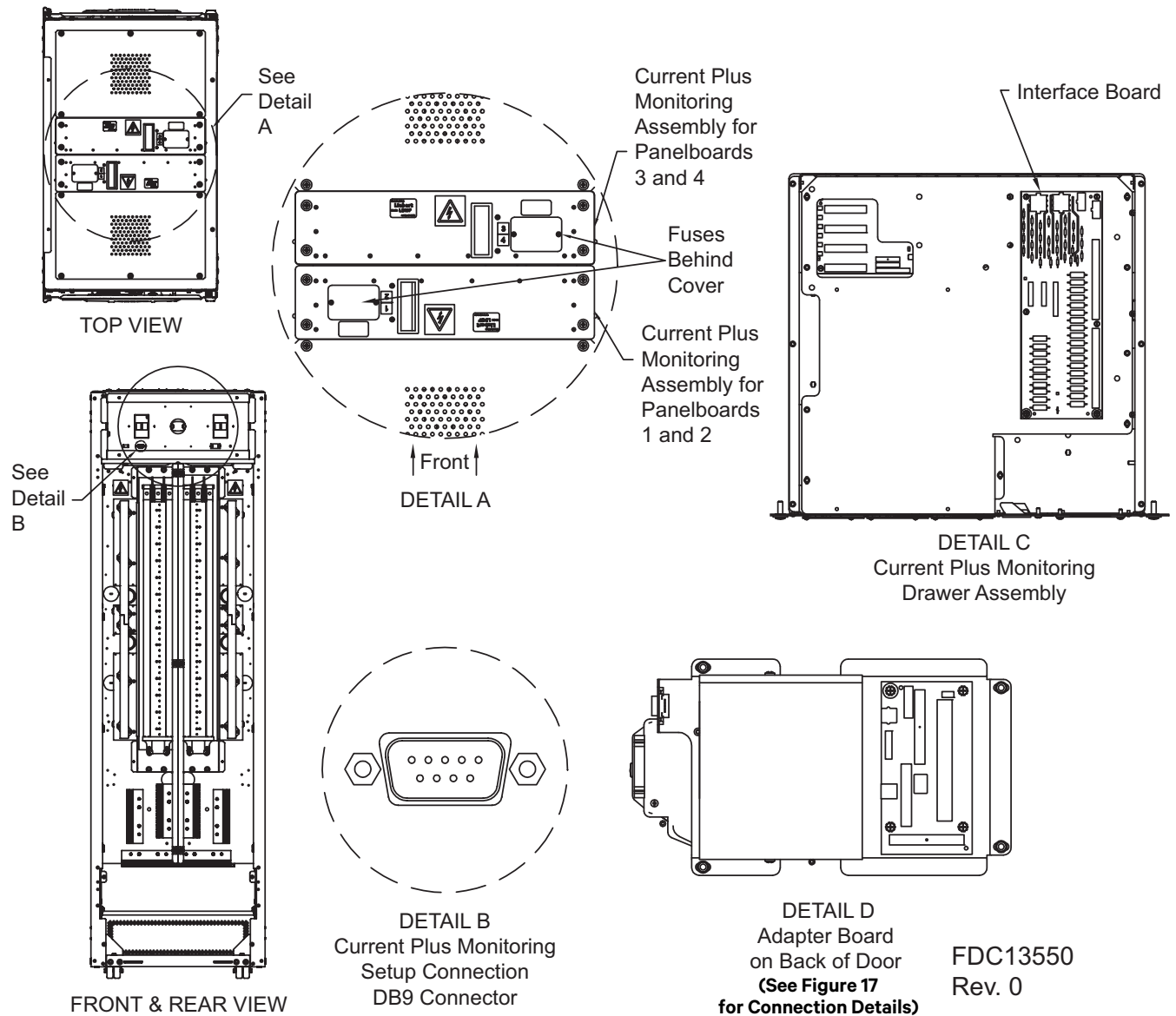

Figure 16 Current Plus Monitoring™ location - top exit

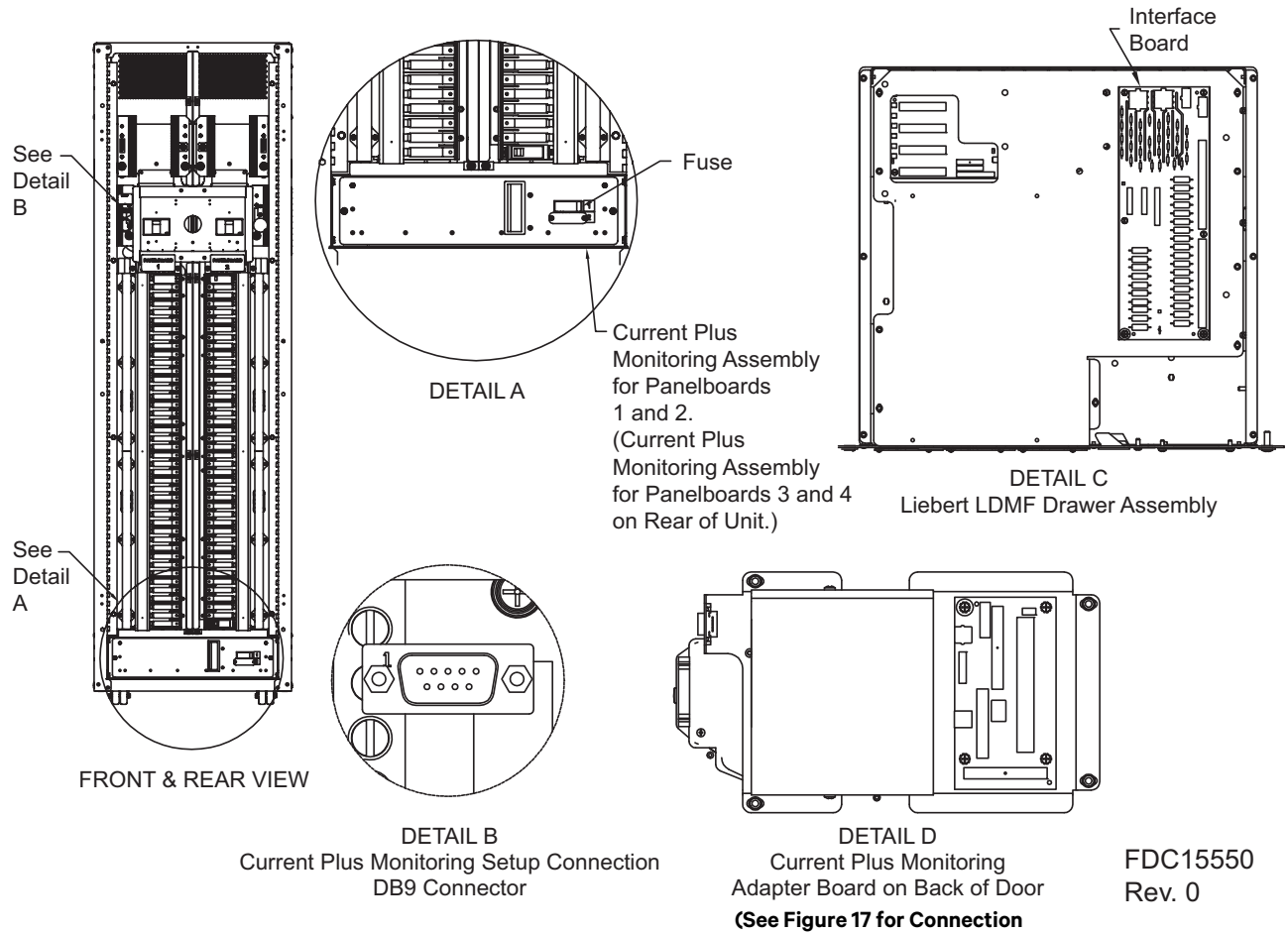
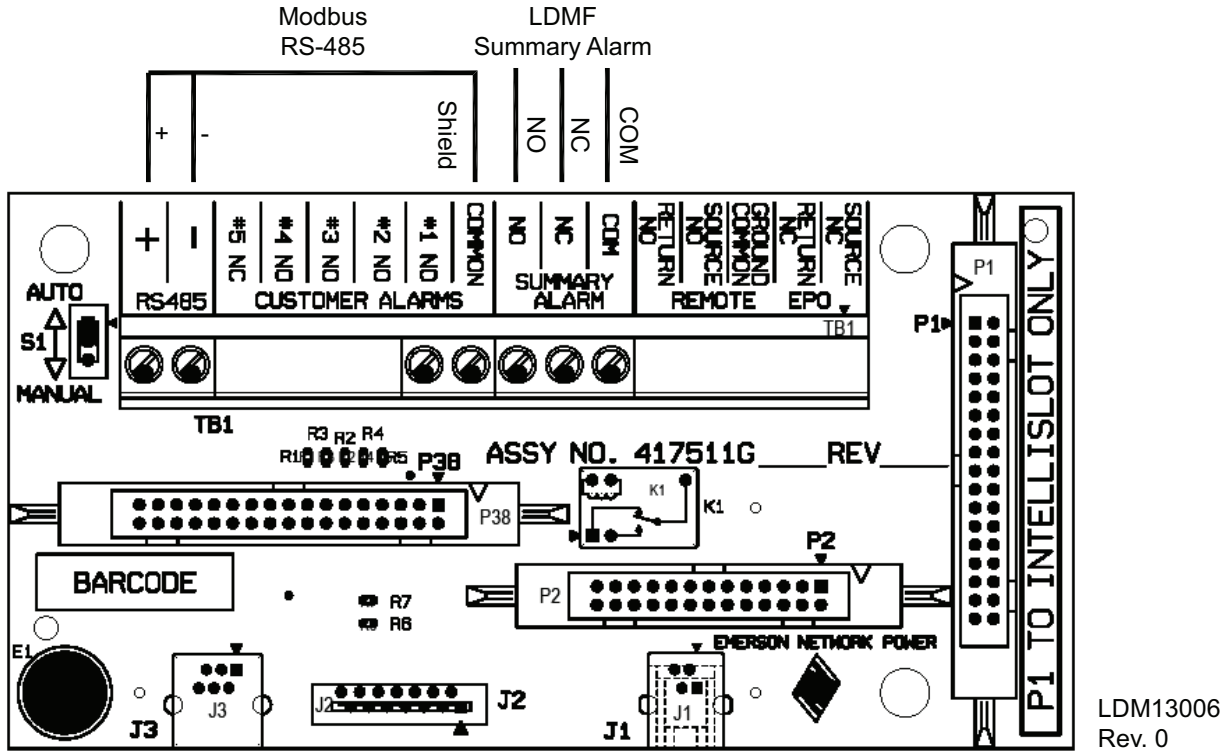

Figure 17 Current Plus Monitoring and Liebert LDMF communication and summary alarm connections



4.4.2 Liebert LDMF™—Optional

Remote communication is available if the optional Liebert LDMF is supplied. The Liebert LDMF has three Liebert IntelliSlot™ bays. Three Liebert IntelliSlot cards can be added for customer connection to a Building Management System (BMS). The Liebert LDMF will communicate to Liebert SiteScan® using the Liebert SiteScan Monitoring Interface option.

See **Figures 18,19,22** and **23** for location and connection details.

Figure 18 Control connections for Liebert LDMF - bottom exit

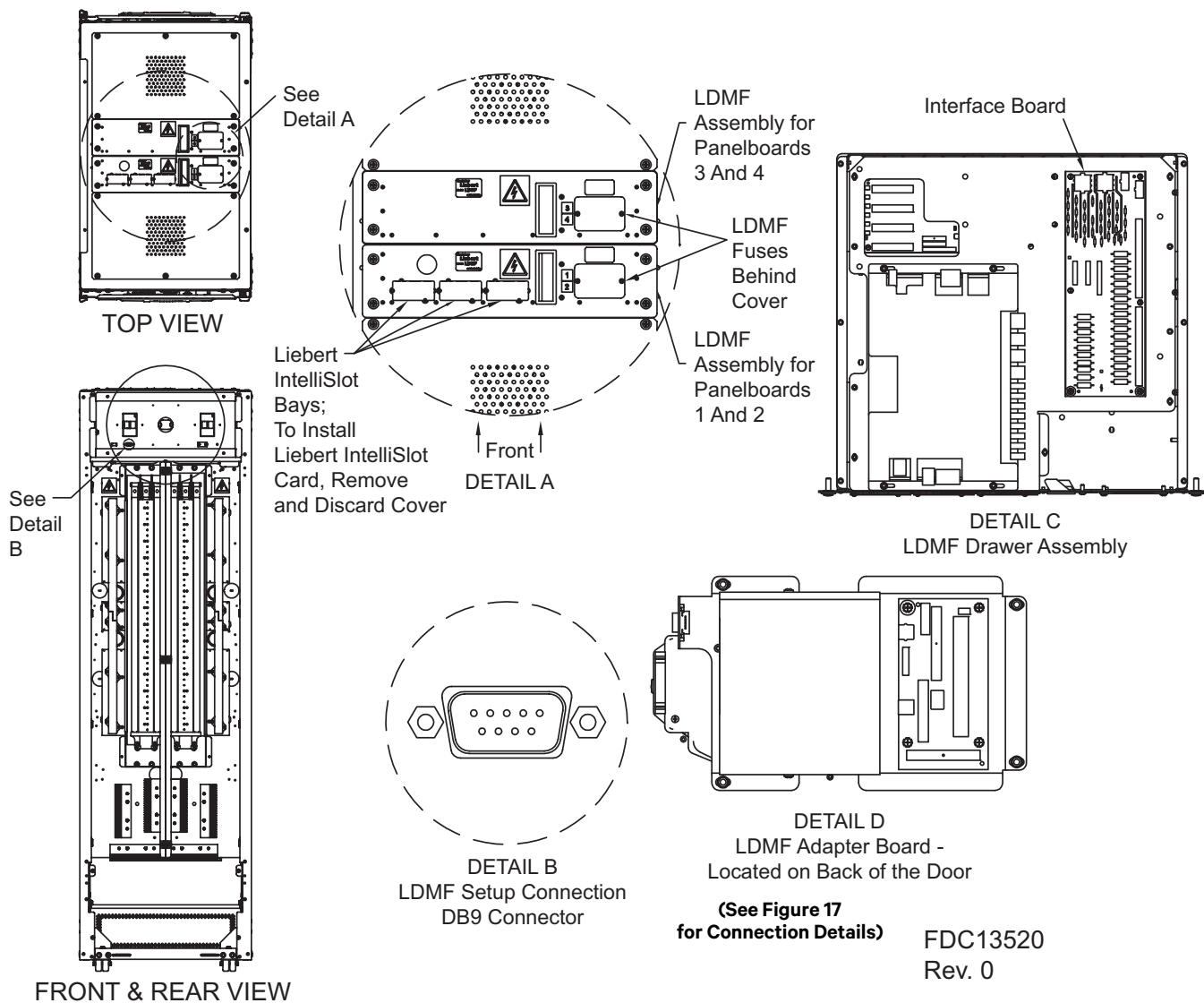

Figure 19 Control connections for Liebert LDMF™ - top exit

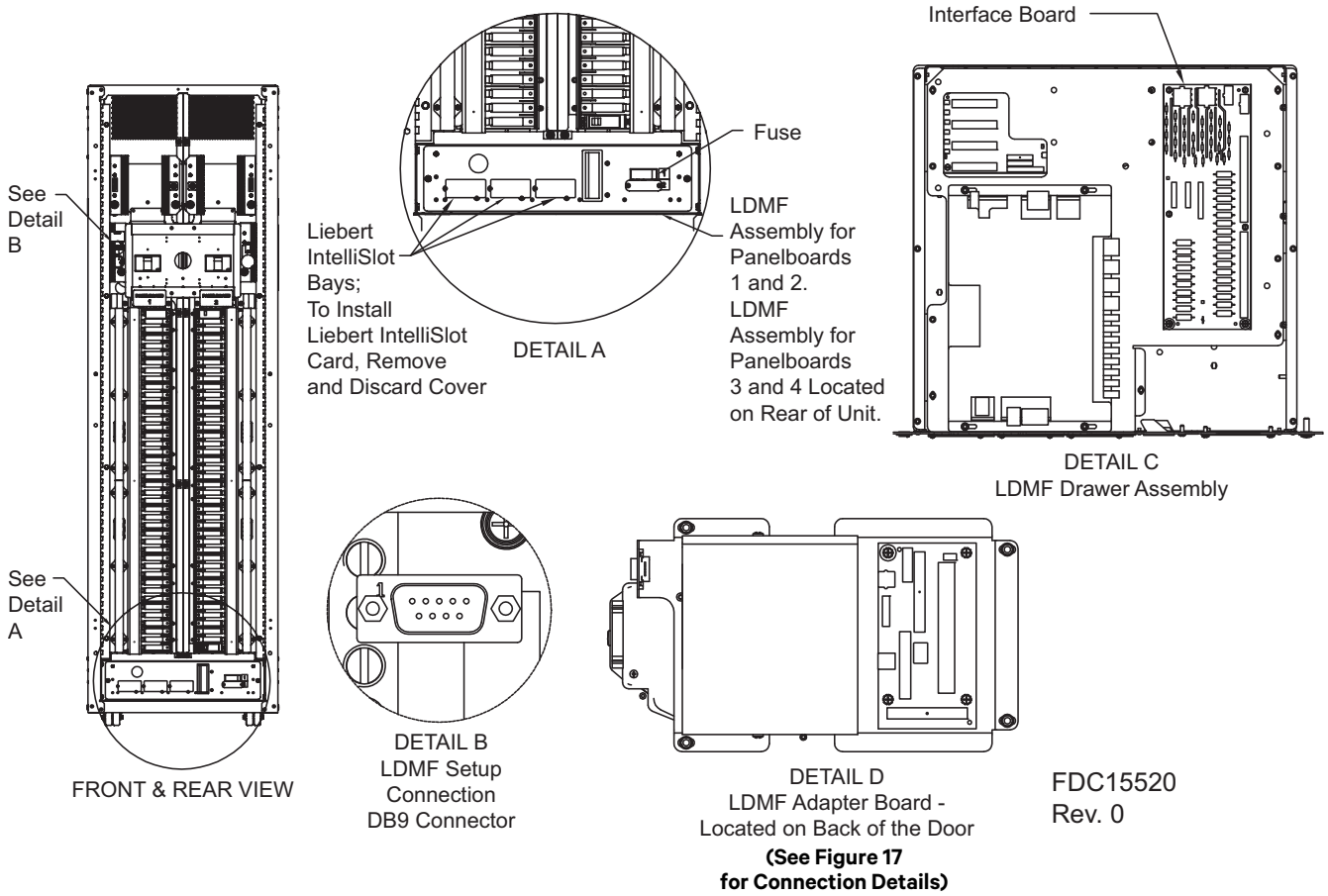

Figure 20 Control connections for Liebert LDMF™ 380-480V, 60Hz

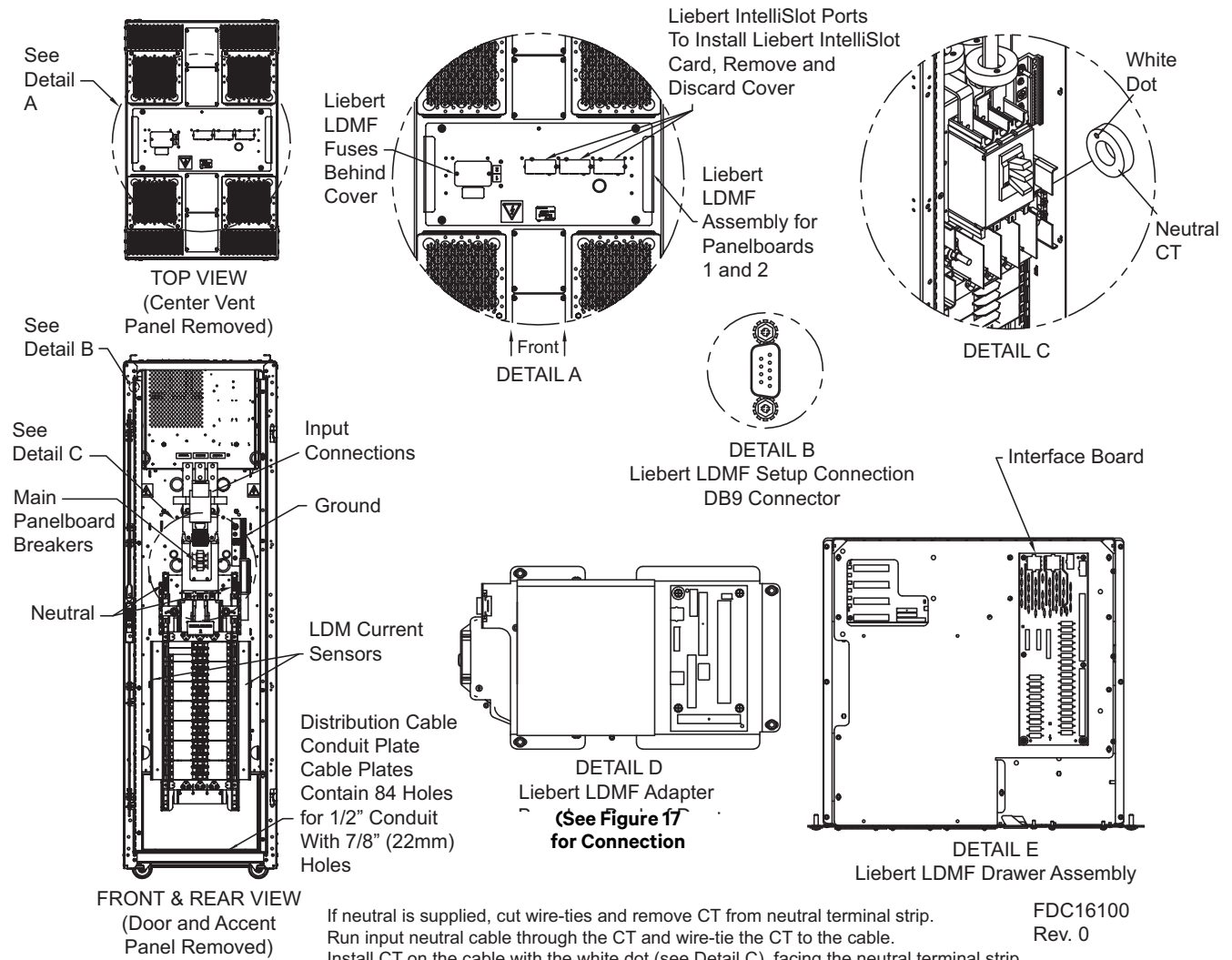
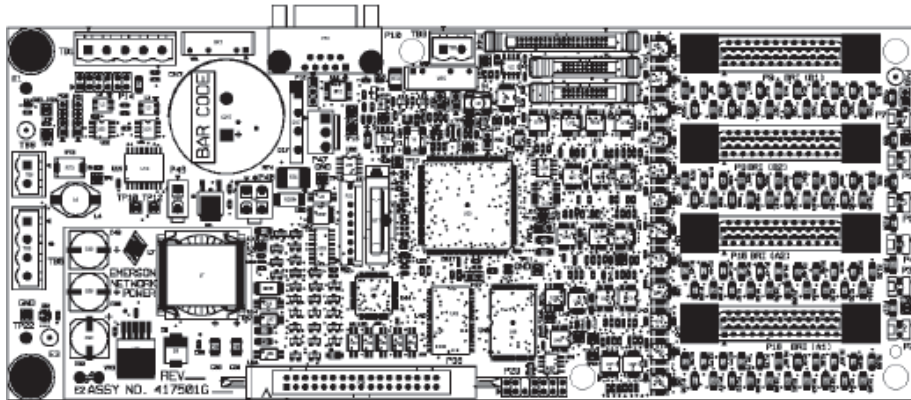
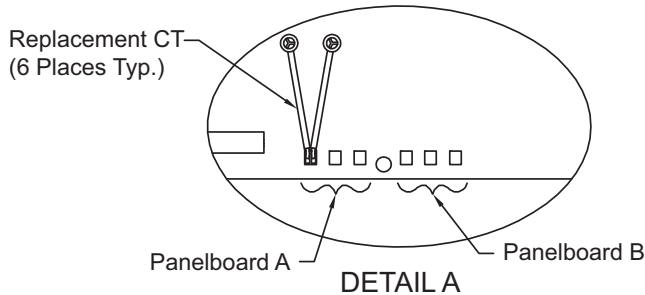
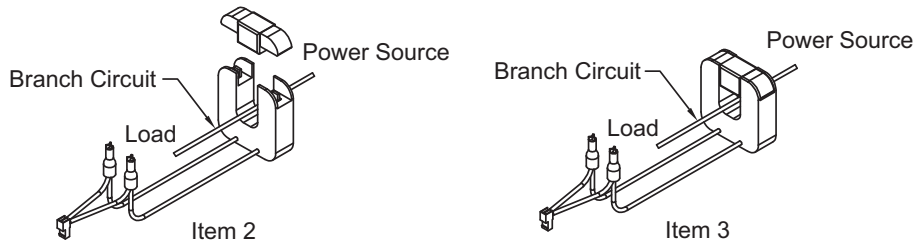

Figure 21 Connections for replacement Current Transformer (CT) for Liebert LDMF™ CT sensor module



Connection Location for CT Module
6 Replacement CTs.
◀ Indicates Pin 1.
Connect CT White Wire to Pin 1
Connect CT Black Wire to Pin 2



LDM13004
Rev. 0

NOTES

1. Remove CT from the box. Route wiring from the transformer through the panel to the Liebert LDMF control board.
2. Connect the CT connector to the proper panel location using the first available connection:
 - a. For Panelboard A, use P2(A1), P3(A2), P4(A3).
 - b. For Panelboard B, use P5(B1), P6(B2), P7(B3).
 Ensure that all routed wiring is properly secured to the panel with tie wraps.
3. The top piece of the current transformer (CT) is removable by pulling away from the center of the transformer (Item 2).
4. Place the main body of the current transformer around the cable, making sure the CT is installed in the direction shown (see Item 2).
5. Replace the top piece of the CT to complete securing the CT around the cable (see Item 3), using the enclosed tie wraps to secure the CT to the cable.



WARNING

Do not open-circuit the secondary windings of current transformers. Failure to follow these instructions may result in serious injury or death

Figure 22 Connections to Liebert LDMF™ SiteScan® monitoring interface - bottom exit

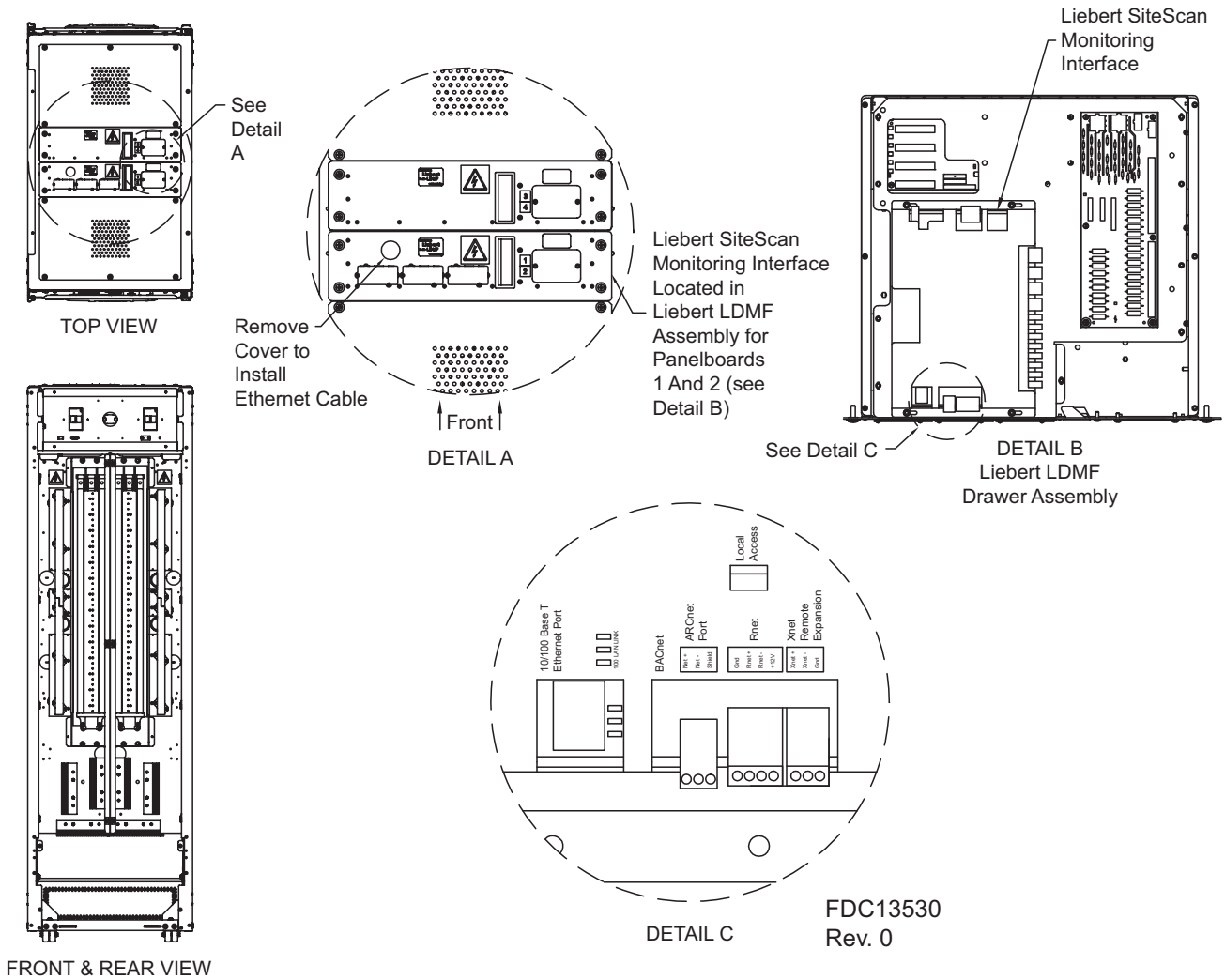
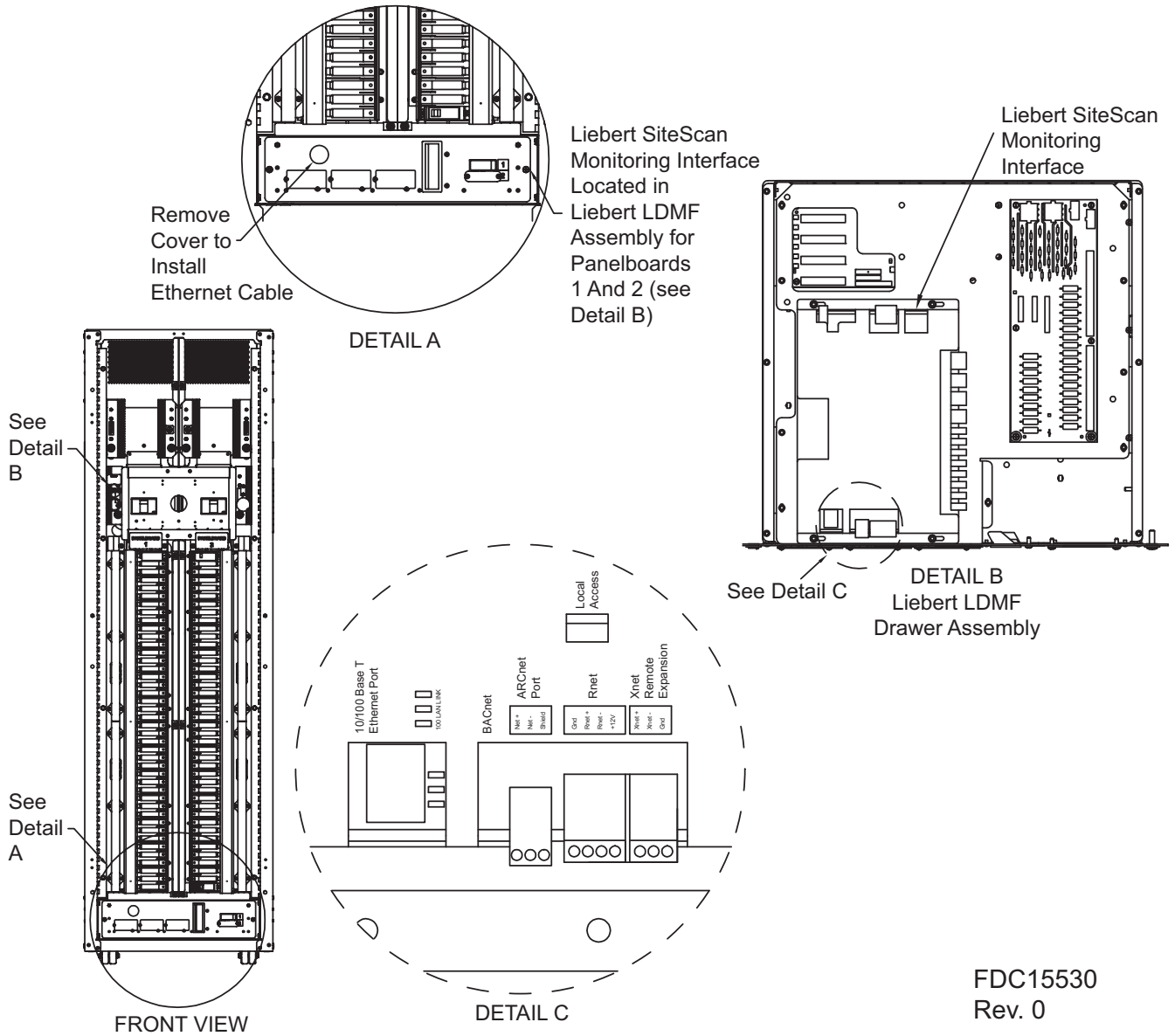

Figure 23 Connections to Liebert LDMF™ SiteScan® monitoring interface - top exit



FDC15530
Rev. 0

5.0 INTRODUCTION TO LIEBERT FDC OPERATION

5.1 System Description

The Liebert FDC is designed to provide additional distribution capacity. The unit can be furnished with one, two, three or four panelboards. While most units are supplied with four panelboards, fewer may be required to meet site requirements and applications.

The Liebert FDC contains vertically mounted Square-D® or GE® panelboards for distribution to the intended loads. Panelboards can be supplied to use either bolt-in or plug-in type branch circuit breakers. The unit is designed to have two panelboards that can be accessed from the front of the unit and two panelboards that be accessed from the rear of the unit. Each panelboard is totally enclosed with a hinged accent panel that provides access to that panelboard without exposing other portions of the unit. The panelboard has a rating of 225A for 208V, 380-415V, 50Hz, and a rating of 400A for 380-480V, 60Hz, with an overall short-circuit current rating of 22kA RMS (208-240V), 35kA (380-480V, 60Hz) symmetrical amperes. Panelboards can be rated for 65kA (380-480V, 60Hz) when the optional 65kA main breaker is used (not available at 380-415V, 50Hz). Each panelboard provides 42 single-pole branch circuit breaker positions. Each panelboard includes separate isolated neutral and safety-ground busbars for the neutral and safety-ground connections for at least 42 output circuits. The neutral busbar and wiring are sized for at least 1.73 times the panelboard full load rating to accommodate high harmonic neutral currents associated with single-phase nonlinear loads.

Each distribution panelboard is protected by a main panelboard circuit breaker. The breaker is UL listed and IEC rated for use at the system voltage. The main panelboard circuit breaker has a rating of 225A or 400A with an overall short-circuit current rating of 22kA or 35kA RMS symmetrical amperes. Optional main panelboard breakers are available rated for 65kA (380-480V, 60Hz) RMS symmetrical amperes (not available at 380-415V, 50Hz).

Monitoring can be supplied, as an option, to monitor current parameters (Current Monitoring Panel) or voltage, current and power parameters; two options are available: Current Plus Monitoring or Liebert LDMF. Front and rear displays are provided with push-button switches for operator interface on some options.

Remote communication is available only on the Current Plus and Liebert LDMF options, which provide external communication through Liebert IntelliSlot™ cards: IS-UNITY-DP card for HTTP/HTTPS, Vertiv Protocol, e-mail, SMS, SNMP v1/v2c/v3, BACnet IP/MSTP and Modbus TCP/RTU output using a serial RS-485 two-wire connection.

5.2 Factory Backup and Service Assistance

Because improper installation can cause a system to fail, a Vertiv or factory-trained service technician should thoroughly inspect the unit to ensure it is properly installed and its operating parameters are properly configured.

If you need assistance or have questions:

- In the United States, call 800-543-2378.
- Outside the 48 contiguous United States contact Vertiv Technical Support, if available in your area. For international areas not covered by Vertiv Technical Support, the Vertiv-authorized distributor can provide technical support.

6.0 EQUIPMENT INSPECTION AND STARTUP

6.1 Exterior Inspection

Exterior Inspection Checklist

- ___ 1. Confirm that the exterior of the unit is undamaged.
- ___ 2. Confirm that service and ventilation clearances are adequate. (See **Figure 6**).

6.2 Internal Inspection

A detailed internal inspection should be performed after the unit is in place and before it is energized, to insure trouble-free startup. The same internal inspection should be carried out when performing preventive maintenance.



WARNING

Verify that all incoming power circuits are de-energized and locked out before performing the internal inspection.

Gain access to the internal components of the Liebert FDC unit by removing the right side panel, if supplied, and the interior panel.

Interior Inspection Checklist

- ___ 1. Inspect all wire and conductor insulation for damage.
- ___ 2. Check all breaker connections for tightness. Retorque if necessary. Unless otherwise labeled, use the recommended tightening torque as shown in **Table 1**.
- ___ 3. Check trip settings of adjustable breakers.
- ___ 4. Check all terminal block connections for tightness. Retorque if necessary. Unless otherwise labeled, use the recommended tightening torque as shown in **Table 1**.
- ___ 5. Remove any foreign objects from the components or the interior area of the unit.
- ___ 6. Check that the exhaust air screen is clean and free of obstructions.

6.3 Startup

A qualified electrician should be employed to perform the equipment inspection and startup. System startup may be arranged by calling your local Vertiv sales representative or Vertiv Technical Support. In the United States, call 800-543-2378.

A copy of the appropriate checklist (furnished with the equipment) must be completed, signed, dated, and returned to Vertiv. Warranty coverage of the equipment is not effective unless the checklist is received by the factory.



WARNING

Equipment inspection and startup should be performed only by properly trained and qualified personnel. Electrical safety precautions must be followed throughout inspection and startup.

Hazardous voltages are present in the equipment throughout the majority of the startup procedure. Use proper safety equipment. Proceed with caution.

Startup Checklist

- ___ 1. Make certain that all circuit breakers are in the Off position and that power to the unit is locked out.
- ___ 2. Verify proper input power connections to unit, including the equipment grounding conductor.
- ___ 3. Turn On the building power to the unit.
- ___ 4. Check the phase rotation at the input terminal blocks. Phase rotation should be A, B, C, left-to-right.
- ___ 5. Check and record the input voltage for each input. Measured voltages should correspond to the unit's nameplate input voltage.

	Input 1	Input 2	Input 3	Input 4
Volts, Phase A to Phase B =				
Volts, Phase B to Phase C =				
Volts, Phase C to Phase A =				

- ___ 6. Check the phase rotation at the panelboard main breakers. Phase rotation should be A, B, C, left-to-right.
- ___ 7. Check and record the input voltage at each of the panelboard main breakers. Measured voltages should correspond to the unit's nameplate input voltage.

	Panelboard 1	Panelboard 2	Panelboard 3	Panelboard 4
Volts, Phase A to Phase B =				
Volts, Phase B to Phase C =				
Volts, Phase C to Phase A =				

If output voltage or phase rotation is incorrect, check for wiring errors or incorrect input voltage, Contact Vertiv Technical Support at 800-543-2378 in the USA or the local factory representative for assistance.

- ___ 8. Turn On the panelboard main breakers.
- ___ 9. Replace internal panel and side panels, if supplied.

6.4 Current Monitoring Panel (Optional)

If the unit is equipped with a Current Monitoring Panel:

1. Turn the unit On.
2. Ensure that the LCD is On. The Current Monitoring Panel displays output and neutral currents for each panelboard (load must be applied to get an accurate reading).

Figure 24 Current Monitoring Panel

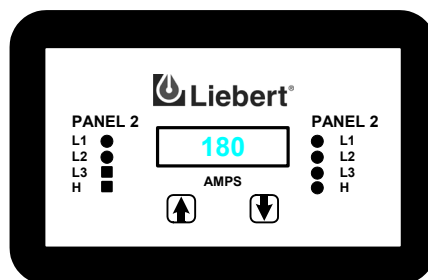

If the monitoring panel is not functioning properly, contact Vertiv Technical Support at 800-543-2378 in the USA or the local factory representative for assistance.

6.5 Current Plus Monitoring™ (Optional)

If the unit is equipped with a Current Plus Monitoring:

1. Turn the unit On.
2. Ensure that the LCD is On. The Current Plus Panel displays volt, currents, frequency, power factor, and power for each panelboard (load must be applied to get an accurate reading).

Displays are located on the front and the rear of the unit.

Figure 25 Current Plus Monitoring panel

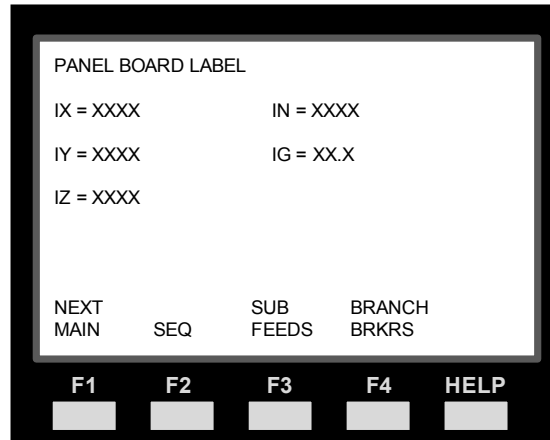

If the monitoring panel is not functioning properly, contact Vertiv Technical Support at 800-543-2378 in the USA or the local factory representative for assistance.

6.6 Liebert LDMF™—Optional

The optional Liebert LDMF is on when power is supplied to the unit. The Liebert LDMF is factory-configured for 1 pole 20A branch breakers. Alarm, alarm setpoints, circuit breaker names and circuit breaker ratings are all field-adjustable through the LDMF SETUP DB-9 connector next to the panelboard main circuit breaker. See the Liebert LDMF user manual, SL-20200, for details.

6.7 Liebert LDMF Display—Optional

If the unit is equipped with a Liebert LDMF display:

1. Turn the unit On.
2. Ensure that the LCD is On. The Liebert LDMF will display voltage, currents, frequency, power factor and power for each panelboard and branch breaker. The load must be applied to get an accurate reading.

7.0 OPERATING INSTRUCTIONS

7.1 Startup Procedures

Perform equipment inspection and startup procedures as detailed in **6.0 - EQUIPMENT INSPECTION AND STARTUP** before the unit is placed in service after initial installation, as well as after equipment relocation and after equipment has been de-energized for an extended period of time.

After initial system startup, the following guidelines can be used for standard equipment operation. These guidelines should be reviewed for any special equipment modifications, special site considerations or company policies that may require changes to the standard equipment operation.

7.1.1 Normal System Turn On

- Make certain all unit circuit breakers are in the Off position. All unit circuit breakers are located behind the front and rear doors.
- Turn On building power to the unit.
- Turn On the panelboard main circuit breakers. If the circuit breaker has been tripped Off (instead of being turned Off), the circuit breaker handle must be moved to the Off position before being turned On.
- Turn On each panelboard circuit breaker Individually, following the load equipment manufacturer's startup sequence.

7.2 Normal System Shutdown

To perform a normal system shutdown:

- Perform an orderly load equipment shutdown according to the load equipment manufacturer's recommended shutdown sequence.
- The load equipment can be turned Off at each piece of load equipment or at the Liebert FDC panelboards (circuit breaker) located behind the unit's front and rear doors.
- Turn Off all unit panelboard main breakers.

To remove all power from the unit, turn Off the building power to the unit.

7.3 Current Monitoring Panel (Optional)

The Current Monitoring Panel consists of a four-digit display in a high-visibility liquid crystal display (LCD) to monitor three-phase and neutral currents for each panelboard. Front and rear LCD's are provided with push-button switches for selecting currents.

7.4 Current Plus Monitoring (Optional)

Current Plus Monitoring provides the current and voltage of each panelboard main circuit breaker. These measurements are used for reporting the average RMS current, power and other parameters.

The CPM reports alarm and status conditions for each panelboard main circuit breaker.

The CPM will also detect and annunciate alarm messages. All alarm thresholds for monitored parameters are adjustable by way of the service port to match site requirements.

The CPM has a Form C summary alarm contacts for remote alarm status—1 NO and 1 NC. The contacts are rated at 24VAC @ 1A. There is one alarm contact for every two (2) panelboard main breakers. The contact changes state upon occurrence of any type of alarm, including a warning alarm, and resets when the alarm is cleared.

All alarms are stored in non-volatile memory to protect against erasure by a power outage. Alarms must be reset manually after the alarm condition has been corrected. Alarms may be reset through Modbus.

Alarms are saved in an event log. The event log stores 128 events using a first-in, first-out (FIFO) method.

CPM has three Liebert IntelliSlot™ bays. Three Liebert IntelliSlot cards can be added for customer connection to a Building Management System (BMS). CPM can communicate to Liebert SiteScan® using an RS-485 connection.

7.5 Liebert LDMF™ (Optional)

The Liebert LDMF monitors the current and voltage for each branch circuit breaker mounted on the panelboards as well as the panelboard main circuit breaker. These measurements are used for reporting the average RMS current, power and other parameters.

The Liebert LDMF reports alarm and status conditions for each branch circuit breaker and the panelboard main circuit breaker. There are three user-settable alarm points for each branch breaker. When the current reaches the setpoints, a separate alarm for each setpoint is generated and communicated to a remote monitoring system.

The Liebert LDMF monitors the power parameters for each branch circuit breaker and panelboard main circuit breaker. The Liebert LDMF will also detect and annunciate alarm messages. All alarm thresholds for monitored parameters are adjustable by way of the service port to match site requirements.

The Liebert LDMF has a Form C summary alarm contact for remote alarm status—1 NO and 1 NC. The contacts are rated at 24VAC @ 1A. The contact changes state upon occurrence of any type of alarm, including a warning alarm, and resets when the alarm is cleared.

All alarms are stored in non-volatile memory to protect against erasure by a power outage. Alarms must be reset manually after the alarm condition has been corrected.

Alarms are saved in an event log. The event log stores 128 events using a first-in, first-out format (FIFO).

The Liebert LDMF has three Liebert IntelliSlot™ bays. Three Liebert IntelliSlot cards can be added for customer connection to a Building Management System (BMS). The Liebert LDMF can communicate to Liebert SiteScan® using the Liebert SiteScan Monitoring Interface option.

8.0 MAINTENANCE

WARNING

Only qualified service personnel should perform maintenance on the Liebert FDC. Lethal voltages exist inside the unit during normal operation. The unit is supplied by multiple AC power sources. Disconnect and lock out all power sources before working inside the unit.

Minimal periodic maintenance of the Liebert FDC is required. As with all electrical distribution components, the system should be regularly inspected for electrical connection integrity, signs of excessive temperatures, dirt accumulation and proper system operation.

Standard electrical troubleshooting procedures should be used to isolate problems in the unit. If you have questions, don't hesitate to contact Vertiv Technical Support.

Repair or replacement of standard items, such as circuit breakers, can be either handled by qualified electricians or referred to Vertiv Technical Support.

Repairs related to the monitoring system should be referred to Vertiv Technical Support.

To contact Vertiv Technical Support for information or repair service in the USA, call 800-543-2378.

8.1 Inspection and Cleaning

Air circulation through the cabinet may cause dust to accumulate on internal components. Cleaning should be done as necessary during electrical inspections.

Annual general system inspections, cleaning and operation checks are recommended to ensure system performance and long service life.

8.2 Inspection Schedule

- It is difficult to establish a schedule for periodic cleaning because conditions vary from site to site. Inspections after the first 24 hours, after 30 days and after six months of operation should help determine a pattern for the inspection schedule.
- Electrical connections and component mountings should be inspected after the first 24 hours, after 30 days and after six months of operation. Inspections should be conducted annually thereafter.
- Ventilation openings and grilles should be inspected and cleaned every six months to one year.
- A complete inspection and operational checkout should be performed annually. This is best done by performing the inspection and startup procedure as detailed in **6.0 - EQUIPMENT INSPECTION AND STARTUP**.
- Vertiv offers a complete range of preventive maintenance services. These include thorough equipment performance checks and calibration of electronics. Contact Vertiv in the USA at 800-543-2378 for details.

8.3 Proper Tightening of Nuts and Bolts

Table 1 shows the recommended tightening torque for all nuts and bolts, unless otherwise labeled. All power connections are designed to remain at proper torque throughout the lifetime of the unit.

Table 1 Torque tightening

Bolt Shaft Size	Grade 5 - Imperial Grade 8.8 - Metric in-lb (Nm)	Electrical Connections	
		With One Belleville Washer in-lb (Nm)	With Two Belleville Washers in-lb (N-m)
10-32 (M5)	25 (3)	35 (4)	—
1/4-20 (M6)	53 (6)	80 (9)	80 (9)
5/16-18 (M8)	107 (12)	180 (20.4)	160 (18)
M8 - ABB Breaker	—	160 (18.1)	—
3/8-16 (M10)	192 (22)	240 (27.1)	240 (27.1)
1/2-13 (M12)	428 (48)	320 (36.2)	—

9.0 SPECIFICATIONS

9.1 Frequency

The Liebert FDC accepts input frequencies of 50Hz and 60Hz. The frequency should be within ± 0.5 Hz of the nominal frequency.

9.2 Input/Output Voltage

Liebert FDC models are available in various voltages. The input voltage must be three-phase AC (4-wire-plus-ground). The voltage should be within $\pm 10\%$ of the nominal voltage. The output voltage must be three-phase AC (4-wire-plus-ground). Nominal output voltage is the same as input voltage. **Table 2** provides nominal voltages listed according to frequency

Table 2 Input/output voltage

60Hz (L-L/L-N)	50Hz (L-L/L-N)
208/120V	208/120V
380/220V	380/220V
400/230V	400/230V
415/240V	415/240V
480/277V	—

9.3 System Current Ratings

The ratings in **Table 3** are based on continuous current rating. These ratings are for all voltages and frequencies. All units are 100% continuous current rated.

Table 3 System current ratings

Inputs	Current per Input
One	720A
Two	360A
Four	180A

9.4 Environmental Requirements

- A. **Storage temperature range** -55 to 85°C (-67 to 185°F)
- B. **Operating temperature range** 0 to 40°C (32 to 104°F)
- C. **Relative humidity** 0% to 95% without condensation
- D. **Operating altitude** Up to 6,600 ft. (2,000m) above Mean Sea Level. Derated for higher altitude applications.
- E. **Storage/transport** Up to 40,000 ft. (12,200m) above Mean Sea Level.
- F. **Audible noise** Less than 45 dBA measured 5 ft. (1.5m) from the surface of the Liebert FDC in normal operation.

9.5 Frame and Enclosure

The frame is constructed of steel painted powder-coat black and pop-riveted to provide a strong substructure. The cabinet is a freestanding NEMA type 1 enclosure and meets IP10 requirements. A tool is required to remove internal accent side panels that access the hazardous voltage area of the unit.

The cabinet dimensions without side panels are a maximum of 23.5 in. wide x 78.5 in. high x 38 in. deep (597 x 1994 x 965mm). The distributed floor weight is less than 250 lb./sq. ft. (1225 kg/sq. m).

9.6 Casters and Leveling

The enclosure has four (4) heavy-duty swivel casters for portability and installation and four leveling feet for final installation.

9.7 Cooling

The unit is convection-cooled. The convection cooling method allows continuous full-load operation. Heat rejection is through a screened, protective top that excludes foreign material.

9.8 Access

The Liebert FDC is designed so all repairs and maintenance can be performed with access to the front, rear and top. (Units with optional side-mounted maintenance tie-breakers require front, rear and right-side access). Retrofitting additional power distribution cables require access to the front or rear of the unit only.

All power connections are designed to maintain proper connection torque over the lifetime of the unit without any maintenance. The integrity of the connections can be checked via infrared scanning safely from the front, rear or top of the unit.

9.9 Cable Access

The unit has removable output cable trays with a minimum of 168 cable/conduit openings. The Liebert FDC is designed for top or bottom cable entry. Output cable access is top or bottom and through the side.

9.10 Doors

The unit has lockable, removable, hinged, perforated front and rear doors that are 16-gauge sheet metal construction with a perforated sheet metal insert to maximize ventilation. Doors provide access to the main panelboard circuit breakers and to all output circuit breakers. Doors and panels are finished in powder-coat black.

9.11 Main Panelboard Circuit Breaker

Each distribution panelboard is protected by a main panelboard circuit breaker. The breaker is UL listed and IEC rated for use at the system voltage. The main panelboard circuit breaker has a rating of 225A with an overall short-circuit current rating of 22kA RMS symmetrical amperes (208-240V only).

9.12 Distribution Panelboards

The Liebert FDC contains up to four vertically mounted Square-D™ or GE™ bolt-in or plug-in panelboards for distribution to the intended loads. Two panelboards can be accessed from the front of the unit, and two panelboards can be accessed from the rear. Each panelboard is totally enclosed with a hinged accent panel that provides access to that panelboard without exposing other portions of the unit. The panelboard has a rating of 225A (208-240V and 380-415V, 50Hz) or 400A (380-480V, 60Hz), with an overall short-circuit current rating of 22kA (208-240V only)

or 35kA (380-480V, 60Hz) RMS symmetrical amperes. Each panelboard provides a total of 42 single-pole branch circuit breaker positions. Each panelboard includes separate isolated neutral and safety-ground busbars for the neutral and safety-ground connections for at least 42 output circuits. The neutral busbar and wiring are sized for at least 1.73 times the panelboard full load rating to accommodate high harmonic neutral currents associated with single-phase nonlinear loads.

9.13 Monitoring

No monitoring is standard. Three options are available:

- Current Monitoring Panel
- Current Plus Monitoring
- Liebert Distribution Monitoring

See **9.14.1 - Current Monitoring Panel**, **9.14.2 - Current Plus Monitoring**, and **9.14.9 - Liebert LDMF™** for details.

9.14 Options

The following options are available for the Liebert FDC:

9.14.1 Current Monitoring Panel

The Current Monitoring Panel consists of a four-digit, high-visibility liquid crystal display (LCD) to monitor current parameters. Front and rear displays are provided with push-button switches for operator interface. The three-phase and neutral currents for each panelboard are displayed. The display and switches are accessible without opening the door. All currents are monitored using true RMS measurements for accurate representation of non-sinusoidal waveforms typical of computers and other sensitive loads.

9.14.2 Current Plus Monitoring

CPM monitors the current and voltage of the panelboard main circuit breaker. These measurements are used for reporting the average RMS current, power and other parameters.

The CPM reports alarm and status conditions for each panelboard main circuit breaker.

CPM has three Liebert IntelliSlot™ bays. Three Liebert IntelliSlot cards can be added for connection to a Building Management System (BMS). CPM can communicate to Liebert SiteScan® using an RS-485 connection.

9.14.3 EZ-View Doors

The enclosure is provided with a removable, lockable, hinged door with a clear acrylic scratch- and impact-resistant insert to allow for external viewing of the branch breakers without opening the door.

9.14.4 Solid Sheet Metal Doors

The enclosure is provided with a removable, lockable, hinged solid sheet metal door.

9.14.5 Plug-In Main Breakers

Plug-in main panelboard circuit breakers are provided to allow easy replacement. The plug-in feature of the breaker includes interlock, which prevents the breaker from being unplugged without being in the Off (open) position. The circuit breakers have a rating of 225A with an overall short-circuit current rating of 22kA RMS symmetrical amperes (208-240V only).

9.14.6 Maintenance Tie-Breakers

Optional maintenance tie-breakers are provided to allow connection of the panelboards in the Liebert FDC to different inputs. The inputs must be fed from the same source so they can be safely tied together. Breakers are located behind a lockable hinged door on the side of the unit. Side access is required with this option.

9.14.7 Isolated Ground Busbar

An isolated ground busbar is provided for each panelboard to connect the output cable isolated ground conductor. The isolated ground busbar is in addition to the standard-equipment ground busbar.

9.14.8 65kAIC Main Panelboard Circuit Breaker (380-480V, 60Hz, units)

The main panelboard circuit breaker shall have an overall short-circuit current rating of 65kA RMS symmetrical amperes.

9.14.9 Liebert LDMF™

The Liebert LDMF monitors each individual branch circuit of 42-pole panelboards. In addition to monitoring the branch circuit breakers, the Liebert LDMF monitors the current and voltage of the panelboard main circuit breaker. These measurements are used for reporting the average RMS current, power and other parameters.

The Liebert LDMF reports alarm and status conditions for each branch circuit breaker and the panelboard main circuit breaker. The Liebert LDMF is supplied with three Liebert IntelliSlot™ bays. Three Liebert IntelliSlot cards can be added for customer connection to a Building Management System (BMS). The Liebert LDMF can communicate to Liebert SiteScan® using the Liebert SiteScan Monitoring Interface option.

9.14.10 Side Panels

The unit is supplied with 20-gauge sheet metal side panels. A 7/32" hex wrench is required to remove the exterior panels that access the hazardous voltage area of the unit.

9.14.11 Export Crating

Heavy-duty solid wood crating can be provided to meet international requirements regarding package strength and special markings for overseas shipments.

9.14.12 Seismic Floor Stands

A floor stand is provided to support and level the unit and provide bottom cabling access without relying on a raised floor for support. The nominal height of the floor pedestals is 18 in. (457mm), 24 in. (610mm), 30 in. (762mm) or 36 in. (914mm).

9.14.13 65kAIC Main Panelboard Circuit Breaker (380-480V, 60Hz, units)

The main panelboard circuit breaker has an overall short-circuit current rating of 65kA RMS symmetrical amperes.

NOTES



