



# Avocent<sup>®</sup> HMX High Performance KVM Extender System

Installer/User Guide

The information contained in this document is subject to change without notice and may not be suitable for all applications. While every precaution has been taken to ensure the accuracy and completeness of this document, Vertiv assumes no responsibility and disclaims all liability for damages resulting from use of this information or for any errors or omissions. Refer to other local practices or building codes as applicable for the correct methods, tools, and materials to be used in performing procedures not specifically described in this document.

The products covered by this instruction manual are manufactured and/or sold by Vertiv. This document is the property of Vertiv and contains confidential and proprietary information owned by Vertiv. Any copying, use or disclosure of it without the written permission of Vertiv is strictly prohibited.

Names of companies and products are trademarks or registered trademarks of the respective companies. Any questions regarding usage of trademark names should be directed to the original manufacturer.

### **Technical Support Site**

If you encounter any installation or operational issues with your product, check the pertinent section of this manual to see if the issue can be resolved by following outlined procedures.

Visit <https://www.vertiv.com/en-us/support/> for additional assistance.

# TABLE OF CONTENTS

<b>1 Product Overview</b>	<b>1</b>
1.1 Features and Benefits	1
1.1.1 Additional video features	1
1.1.2 USB support	2
1.1.3 Transport Layer Security (TLS)	2
1.1.4 Vertiv™ Avocent® HMX Advanced Manager software	2
1.2 Extender System Devices	2
1.2.1 Extender interfaces	2
1.2.2 Firmware upgrades	2
1.2.3 Device ports	3
1.2.4 Management and VNC ports	3
1.2.5 Device status indicators	10
1.2.6 HMX 5150T/6150T transmitter	11
<b>2 Installation and Configuration</b>	<b>13</b>
2.1 Configuration Options	13
2.2 System Recommendations	14
2.2.1 Factory reset	15
2.3 Basic Configuration	15
2.3.1 Firmware upgrade	18
2.4 HMX 5150T/6150T Transmitter	18
2.4.1 USB and power connections	19
2.4.2 Status indicators	19
2.4.3 Restoring a firmware backup	20
2.4.4 Performing an upgrade	20
2.4.5 Configuring the HMX 6150T transmitter	21
2.4.6 Factory resetting the HMX 5150T and 6150T transmitters	21
<b>3 System Configuration Utility</b>	<b>23</b>
3.1 General Operations	23
3.1.1 Locating an extender within a rack or data center	23
3.1.2 Enabling system messages	23
3.1.3 Enabling HMX Advanced Manager server control	24
3.1.4 Recording bandwidth statistics	24
3.1.5 Rebooting and resetting the extender's factory default	24
3.2 Advanced Transmitter Configuration	24
3.2.1 Configuring transmitter video	24
3.2.2 Viewing video snapshots and reports	26
3.2.3 Configuring the transmitter USB and security settings	26
3.2.4 Configuring the HMX 6210T transmitter	27
3.3 Advanced Receiver Configuration	27

- 3.3.1 Configuring receiver video ..... 28
- 3.3.2 Configuring receiver USB and security settings ..... 28
- 4 Configuring the HMX 6500 Receiver ..... 31**
- 4.1 Network Connections ..... 31
- 4.2 OLED Screen ..... 31
  - 4.2.1 Front panel indicator ..... 32
  - 4.2.2 Viewing the configuration page ..... 33
- 5 Configuring the HMX 8000 system ..... 35**
- 5.1 General Information ..... 35
- 5.2 UI Settings ..... 36
- 5.3 Presets ..... 36
- 5.4 Ports ..... 37
  - 5.4.1 Video ports ..... 37
  - 5.4.2 Audio Ports ..... 37
  - 5.4.3 USB Ports ..... 38
  - 5.4.4 Serial Ports ..... 39
- 5.5 Network ..... 39
- 5.6 Diagnostics and Statistics ..... 40
  - 5.6.1 Log Settings ..... 40
  - 5.6.2 Network Statistics ..... 41
  - 5.6.3 Video Port Status ..... 41
  - 5.6.4 Video Port Statistics ..... 43
- 5.7 System ..... 44
- 5.8 Fiber Modules and Cables ..... 44
- Appendices ..... 47**
- Appendix A: Technical Specifications ..... 47
- Appendix B: Pinout Information ..... 60
- Appendix C: On-Screen Display ..... 61
- Appendix D: Supported Video Modes ..... 66
- Appendix E: Troubleshooting ..... 67

# 1 Product Overview

The Vertiv™ Avocent® HMX Advanced High Performance KVM extender system is the next generation of Avocent keyboard, video and mouse (KVM) products. The system offers flexible ways to link receivers, transmitters and systems via standard networks.

## 1.1 Features and Benefits

The HMX 5000, 6000 and 8000 series extenders provide a high-performance, reliable desktop extension experience by converting high quality DVI or DP and 4K video, audio and USB data into Internet Protocol (IP) messages. Via the included web-based System Configuration utility, you can customize and enable audio options for the transmitters and receivers throughout your system. All models support copper-based Gigabit Ethernet cabling and Fiber Channel over Ethernet (FCoE). Dual models allow these to be used in parallel to provide additional Gigabit connection speeds as well as link redundancy that maintains operation in the event of a failed connection.

The HMX high performance extenders support single-head video at single-link resolutions, but the dual models of both series also support dual-head video at two single or one dual-link resolution. Within the HMX 6000 extender series, the HMX 6210T extender also has a built-in Virtual Network Computing (VNC) server allowing it to stream low-bandwidth versions of high-resolution output (via a dedicated Ethernet port). This allows remote access via a VNC viewer, through any standard network.

The HMX 8000 extender provides dual-head 4K video, audio and USB delivered over a fiber connection.

**Table 1.1 Model Descriptions**

Options	HMX 5100 Extenders	HMX 5200 Extenders	HMX 6200 Extenders	HMX6200 (DP) Extenders	HMX 6210T Transmitter	HMX 8000 extenders
Primary video	Single-link	Single-link	Dual-link	DP++	Dual-link	DP
Secondary video	No	Single-link	Single-link	DP++	Single-link	DP
VNC support	No	No	No	No	Yes	No
Copper cable support	Yes	Yes	Yes	Yes	Yes	Yes
Fiber cable support	Yes	Yes	Yes	Yes	Yes	Yes

### 1.1.1 Additional video features

The HMX extender system allows you to choose how to compress video transmission across your network. The system is automatically loaded with a lossless codec compression Run-Length Encoding (RLE) scheme which encodes or decodes a digital data stream or signal to improve the appearance of natural images, gradients or shadows. If you do not need "pixel perfect" results for your images, a compression scheme that can be added and configured to provide increased system speed.

#### Anti-dither capability

While the dithering process smooths the appearance of gradually shaded areas in video images, it can slow down system performance. If using Apple Mac or other computers with dithered video output in your network, the HMX extender system provides an anti-dither capability to increase performance and reduce network traffic.

**NOTE: Enabling the anti-dither feature may produce slight color inaccuracies on the monitor.**

## Extended Display Identification Data (EDID) management

The EDID is used to provide details to the monitor graphics card so it uses the optimal video resolution. With the HMX extender system, you can use the EDID of the monitor connected to the receiver or use a fixed EDID that is stored on the transmitter.

### 1.1.2 USB support

The HMX extender system transmitters use USB Emulation technology, which enables faster keyboard and mouse switching for up to 13 different USB devices or an infinite amount of the same devices. This technology emulates certain USB peripheral signals to the computer, causing those peripherals to appear permanently connected to the computer, even when the receivers are switched elsewhere. Other supported USB devices include Human Interface Devices (HID), storage devices such as flash drives and various printers, scanners and serial adaptors.

**NOTE: The HMX extender system does not support isochronous USB devices such as microphones, speakers, webcams and television receivers.**

### 1.1.3 Transport Layer Security (TLS)

The HMX extender system supports the industry standard TLS protocol which offers protection against third party monitoring and tampering when data is transferred across networks.

### 1.1.4 Vertiv™ Avocent® HMX Advanced Manager software

The HMX Advanced Manager software is a secure, web browser-based, centralized, enterprise management solution that provides remote management and monitoring of the extender system. The software handles all administration, access control, monitoring and firmware upgrades across the extender system. For more information on the HMX Advanced Manager software, see the Vertiv™ Avocent® HMX Advanced Manager Software Installer/User Guide.

**NOTE: When using the HMX Advanced Manager software server to configure your HMX extender system, ensure that all transmitters and receivers are set to their factory defaults. Otherwise, they will not be located by the HMX Advanced Manager server.**

## 1.2 Extender System Devices

Within the HMX extender system, transmitters and receivers allow you to seamlessly access and share one or more remote computers that are physically separated from your local work environment.

### 1.2.1 Extender interfaces

Administrators and users can manage and configure transmitters and receivers in the extender system through a web-based System Configuration utility. Receivers within the system also have an On-Screen Display (OSD) that allows users to establish target connections from a local keyboard and mouse.

### 1.2.2 Firmware upgrades

Transmitters and receivers are flash upgradable at any time to ensure that your system is running the most current version available. If your system is running the most current firmware version and is managed by the HMX Advanced Manager software, then that same version must be used across all units in your system. Firmware versions can be mixed in configurations not using the HMX Advanced Manager software, but it is always recommended to use the most current version.

### 1.2.3 Device ports

Transmitters and receivers in the HMX extender system share similar port layouts and functionality. After the general descriptions provided in this section, the following graphics illustrate where these ports and other features are located on the transmitters and receivers. For more information on configuring and working with these ports, see [System Configuration Utility on page 23](#).

#### System and Teaming ports

The system port on transmitters and receivers is the default location to connect devices in either a direct connect configuration or a matrix configuration. On HMX extender dual-head models, the teaming port can be used in conjunction with the system port to provide immediately increased connection speeds of up to 2 Gigabits per second. On HMX 8000 models, you can use two 10gb fiber cables for connection speeds up to 20 GB per second. Using these ports together also improves video, audio and peripheral feed quality, increases bandwidth in your system and creates link redundancy that can maintain operation in the event of a failed connection. The web-based System Configuration utility can be accessed from either port, although the system port is the default location.

#### Serial port

The AUX serial port on transmitters and receivers allows RS232 signals to be extended up to a baud rate of 115200.

### 1.2.4 Management and VNC ports

HMX extender dual-head transmitters and receivers have a port on the left side of the front panel. For the HMX 6210T transmitter, this port is a VNC port that transmits low-bandwidth video output to authorized remote viewers. On the remaining dual-head models, this port is a management port that allows you to access the System Configuration utility if the system port is already in use due to the extenders operating in a direct connect configuration.

Figure 1.1 Avocent® HMX Receiver Overview (Dual Head HMX 6200 DVI-D Receiver Shown)

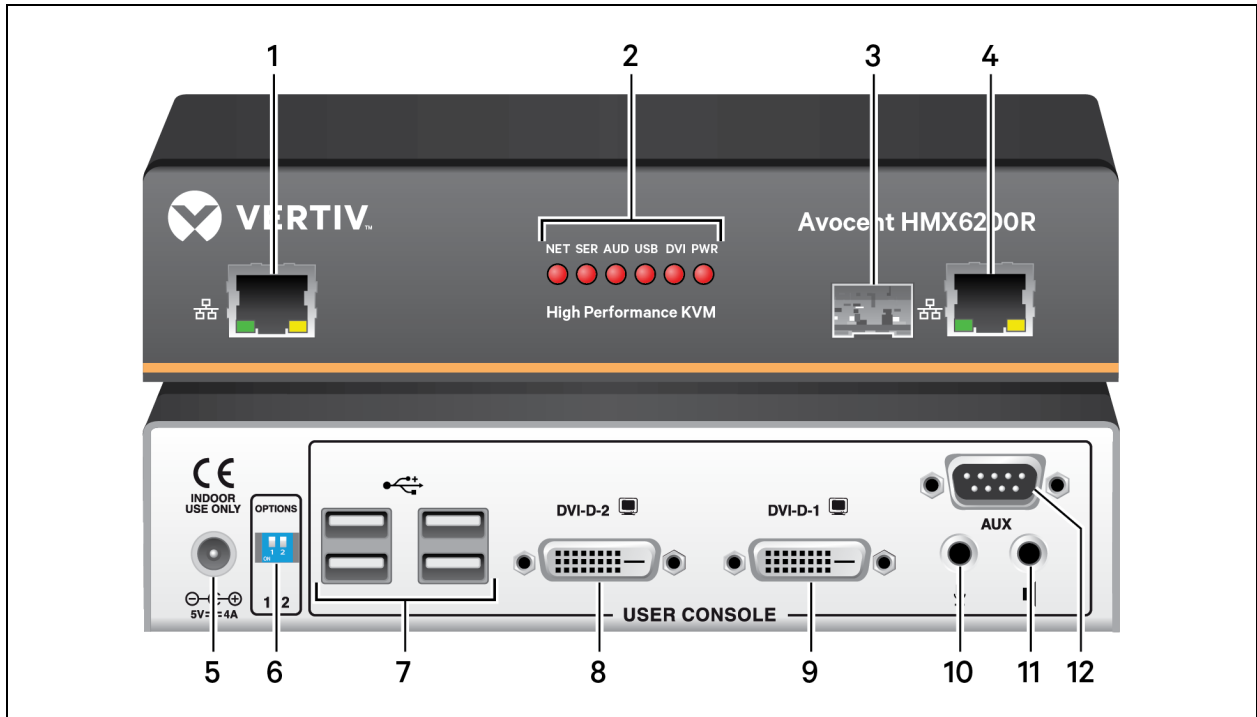

Table 1.2 Avocent® HMX 6200 DVI-D Receiver Descriptions

ITEM	Description
1	HMX 5200/6200 receivers: Management port. This port appears on dual-head models only.
2	Device status indicators.
3	Teaming port.
4	System port.
5	Power input.
6	Option switches.
7	USB peripheral device connection, such as keyboard or mouse.
8	Video output on single-head receivers; secondary port on dual-head receivers.
9	Primary video output on dual-head receivers.
10	Audio in.
11	Audio out.
12	Serial (AUX) port.



Figure 1.2 Avocent® HMX6200 DP Receiver Overview

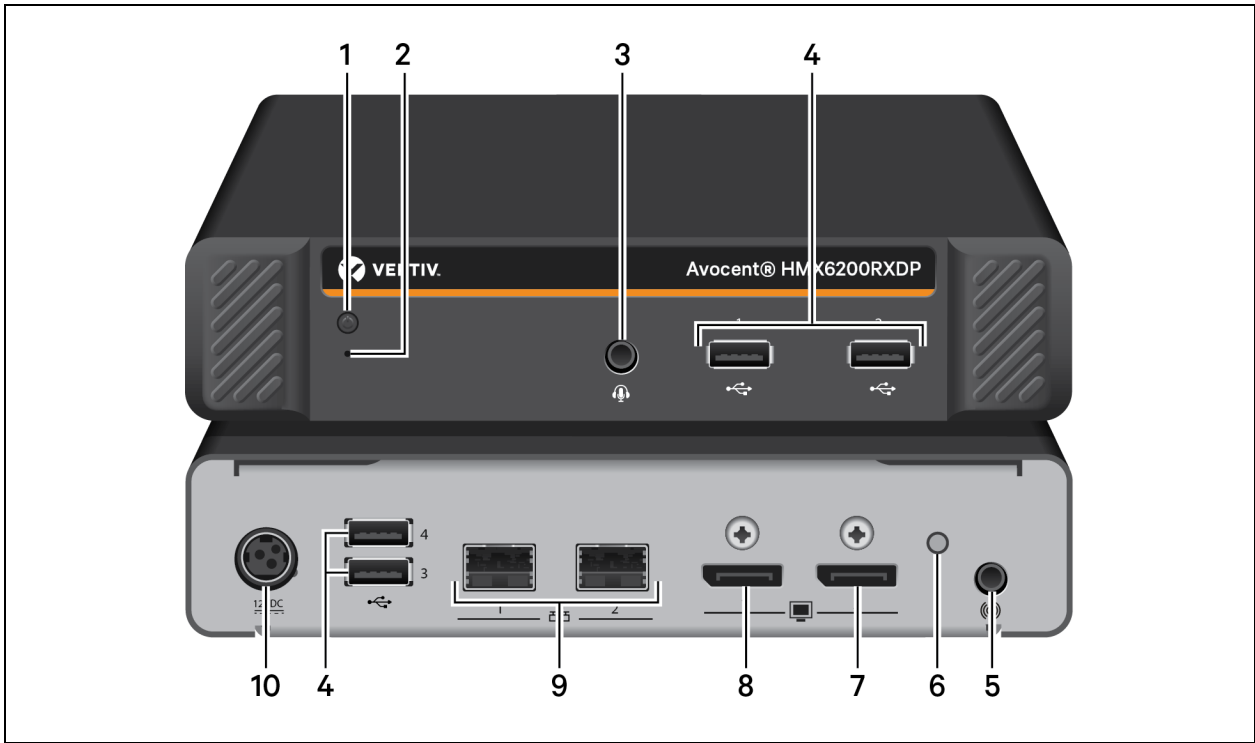

Table 1.3 Avocent® HMX 6200 DP Receiver Descriptions

ITEM	Description
1	Status indicator
2	Reset switch
3	Headphone/headset port
4	USB peripheral device connection, such as keyboard or mouse
5	Analog audio line out
6	Status indicator
7	Secondary display port
8	Primary display port
9	SFP port
10	Power input

Figure 1.3 Avocent® HMX6500 DP Receiver Overview

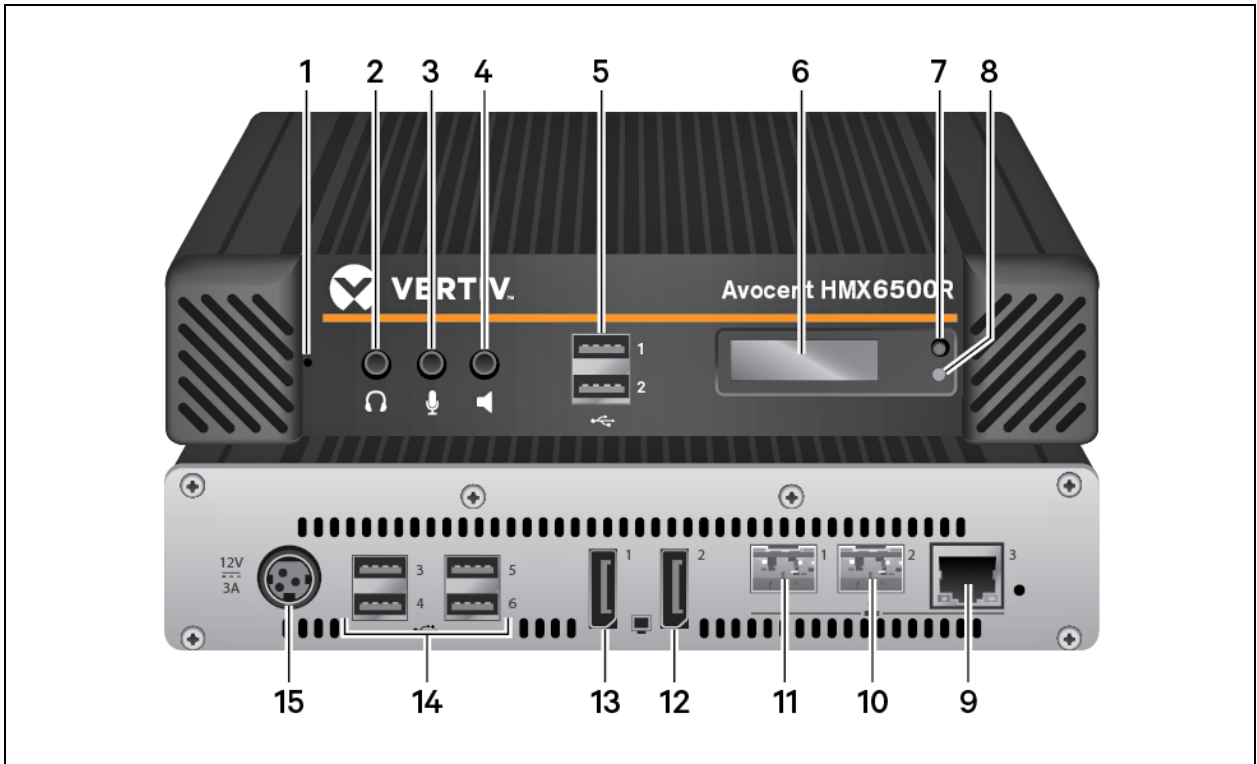

Table 1.4 HMX 6500 Receiver Overview Descriptions

Item	Description	Item	Description
1	Reset switch	9	RJ45 network port
2	Headphones port	10	Secondary SFP port
3	Microphone port	11	Primary SFP port
4	Audio line-out port	12	Secondary display port
5	USB ports	13	Primary display port
6	OLED display	14	USB ports
7	OLED control button	15	Power input
8	OLED status indicator		

Figure 1.4 Avocent® HMX 8000 Receiver Overview

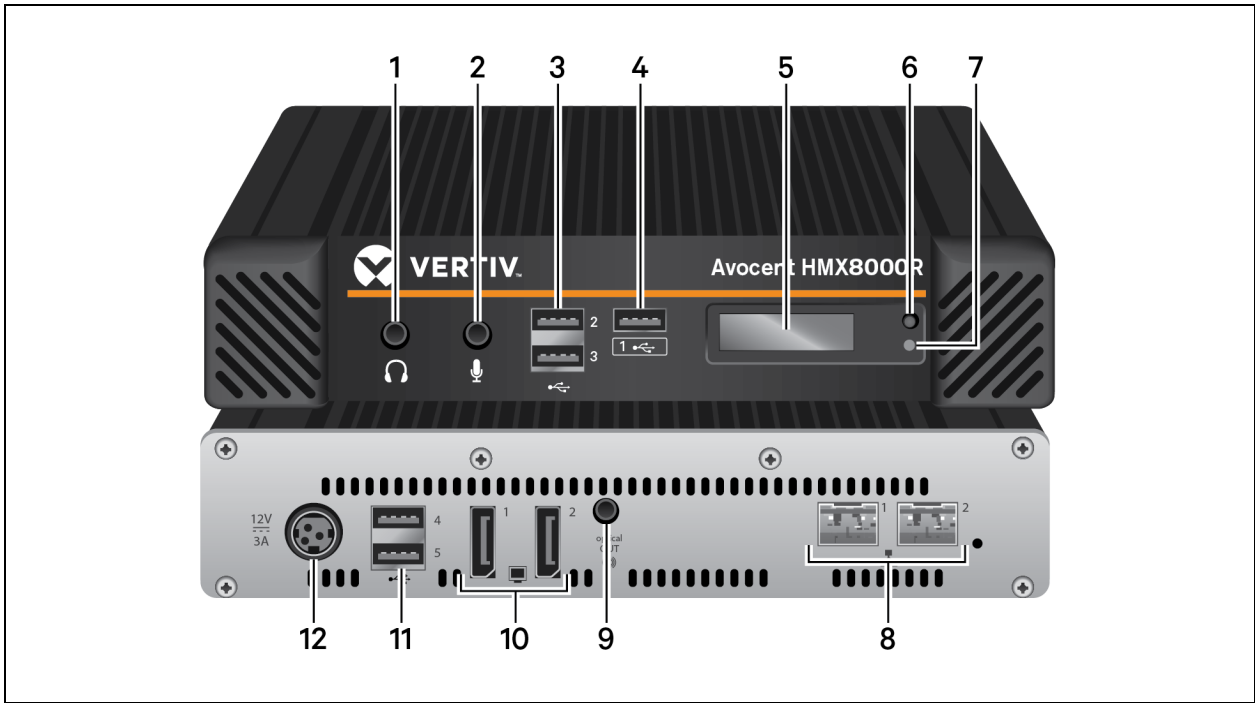
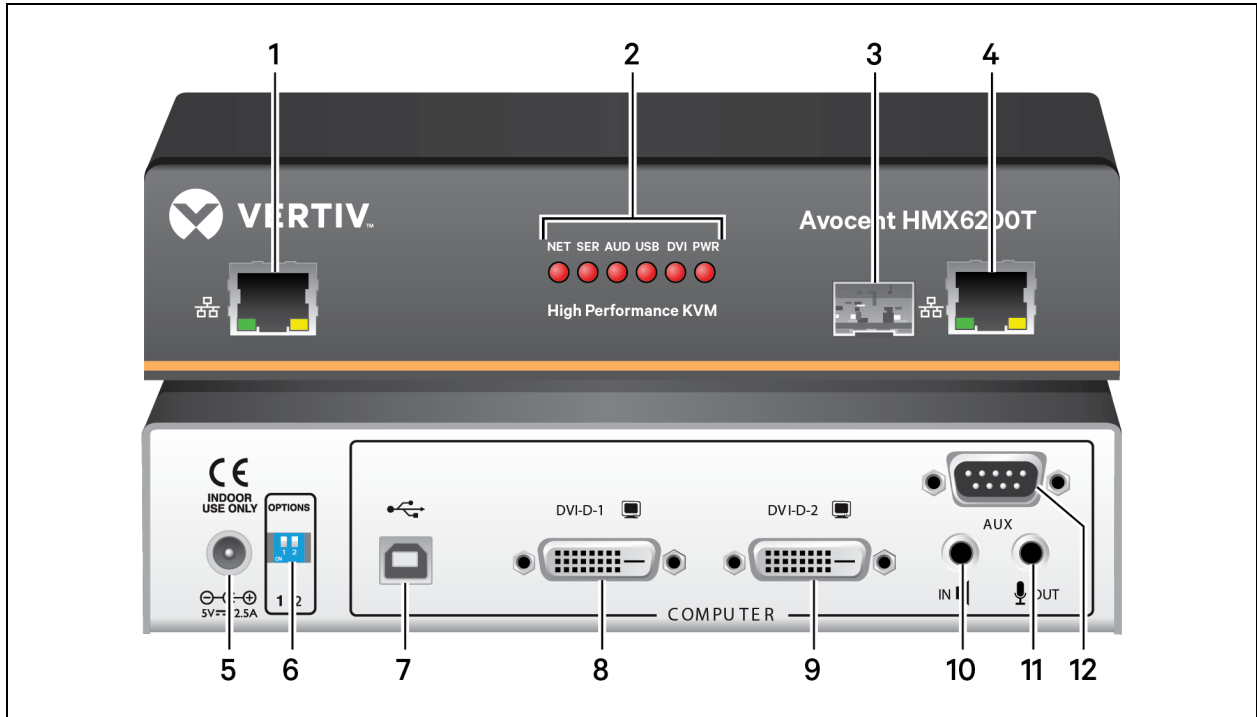

Table 1.5 HMX 8000 Receiver Overview Descriptions

item	Description	item	description
1	Headphones port	7	OLED status indicator
2	Microphone port	8	SFP ports NOTE: Some models have two RJ45 ports next to the SFP ports
3	USB ports 2 and 3. These ports are used for USB devices such as a mouse or keyboard.	9	Audio port
4	USB port 1. This port is dedicated for USB high-speed data transfer.	10	Display ports
5	OLED display	11	USB ports
6	OLED control button	12	Power input

**Figure 1.5 Avocent® HMX Transmitter Overview (Dual Head HMX 6200 DVI-D Transmitter Shown)**



**Table 1.6 Avocent® HMX 6200 DVI-D Transmitter Descriptions**

Item	description
1	This port appears on dual-head models only. HMX 5200/6200 transmitters: Management port. HMX 6210T transmitters: VNC port.
2	Device status indicators. On the HMX 6210T transmitter, the NET indicator is replaced with a VNC indicator.
3	Teaming port.
4	System port.
5	Power input.
6	Option switches.
7	USB port connection.
8	Single-head models only have one video output option. On dual-head transmitters, this is the primary video output. NOTE: The order of the primary (left) and secondary (right) video output on transmitters is the opposite order of the primary (right) and secondary (left) video output on receivers.
9	On dual-head receivers, this is the secondary video output.
10	Audio in.
11	Audio out.
12	Serial AUX port.

Figure 1.6 Avocent® HMX 6200 DP Transmitter Overview

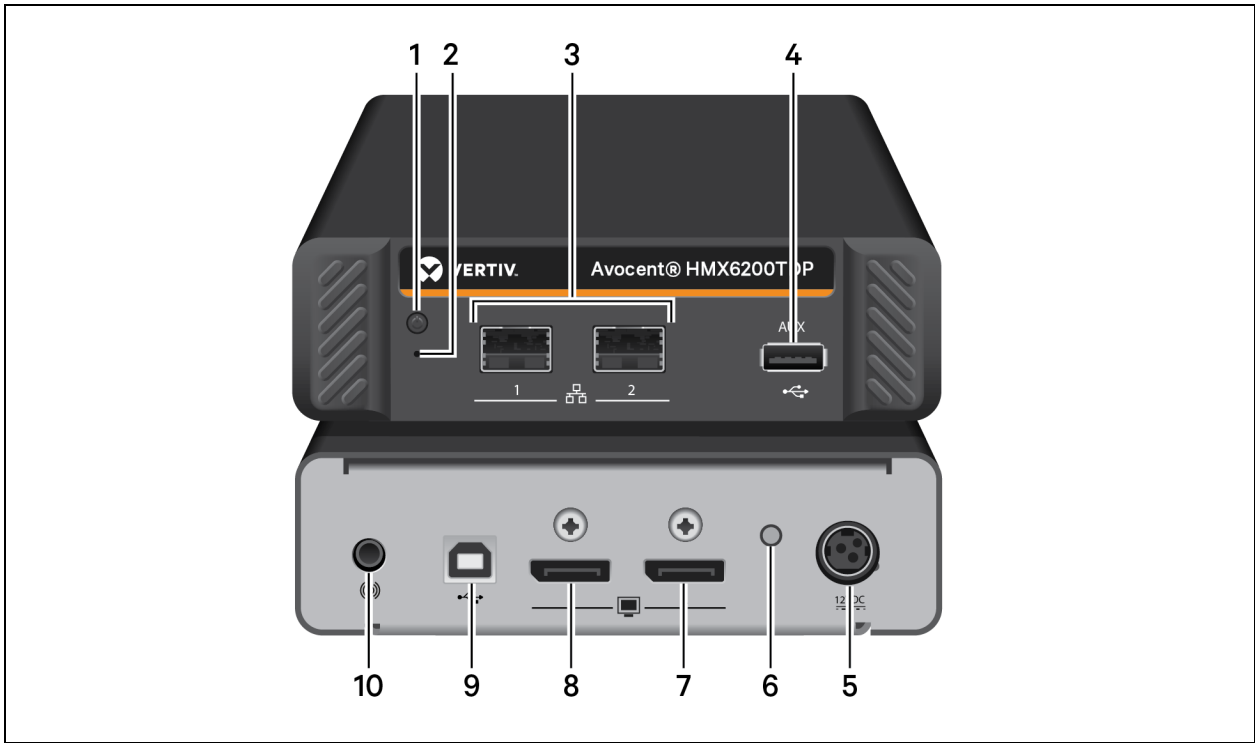

Table 1.7 Avocent® HMX 6200 DP Transmitter Descriptions

Item	description
1	Status indicator
2	Reset switch
3	SFP port
4	USB AUX port for use with USB-to-serial converters
5	Power input
6	Status indicator
7	Primary display port
8	Secondary display port
9	USB port
10	Audio in

Figure 1.7 Avocent® HMX 8000 Transmitter Overview

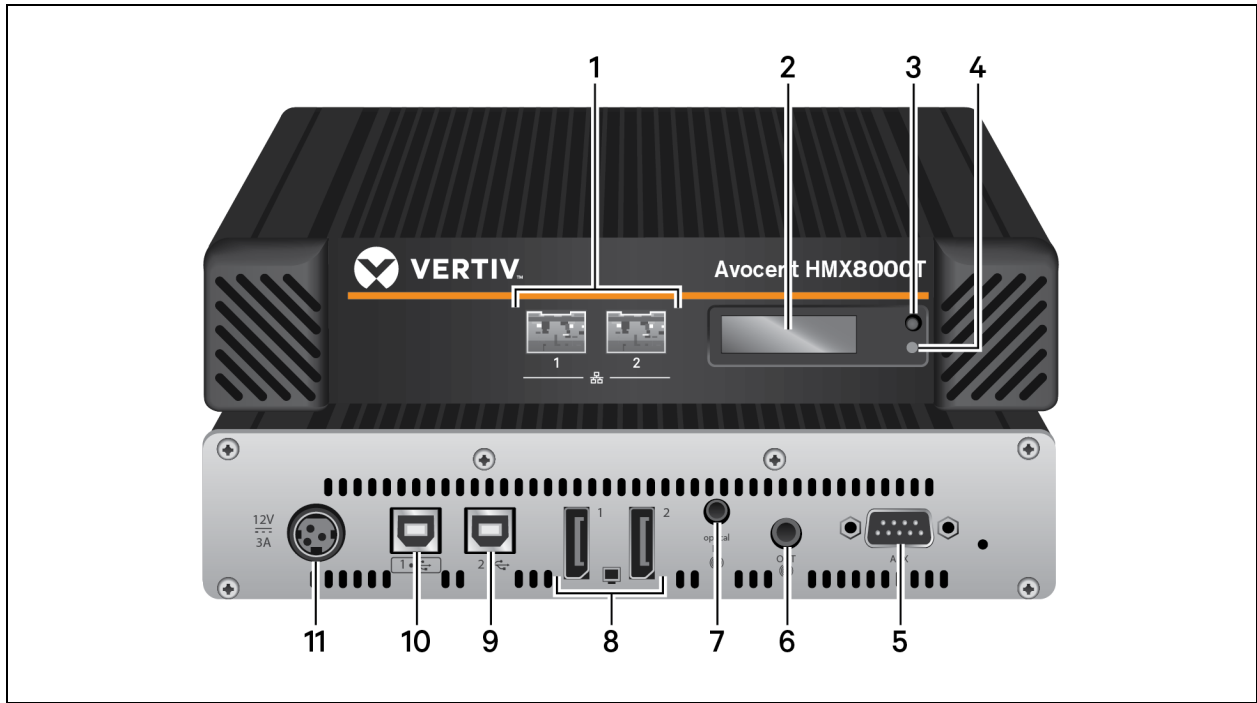

Table 1.8 Avocent® HMX 8000 Transmitter Overview Descriptions

Item	Description	Item	Description
1	SFP ports NOTE: Some models have two RJ45 ports next to the SFP ports	7	Audio in port
2	OLED display	8	Display ports
3	OLED control button	9	USB port 2. This port is used for USB devices, such as a mouse or keyboard.
4	OLED status indicator	10	USB port 1. This port is dedicated for USB high-speed data transfer.
5	Serial AUX port	11	Power input
6	Audio out port		

### 1.2.5 Device status indicators

Transmitters and receivers in the HMX extender system have six device status LED indicators on their front panels. Indicator color and behavior (static or flashing) varies, depending on the activities you are performing with the HMX extender. As a general rule, if the LED stays lit, the function is active.

Figure 1.8 Device Indicators

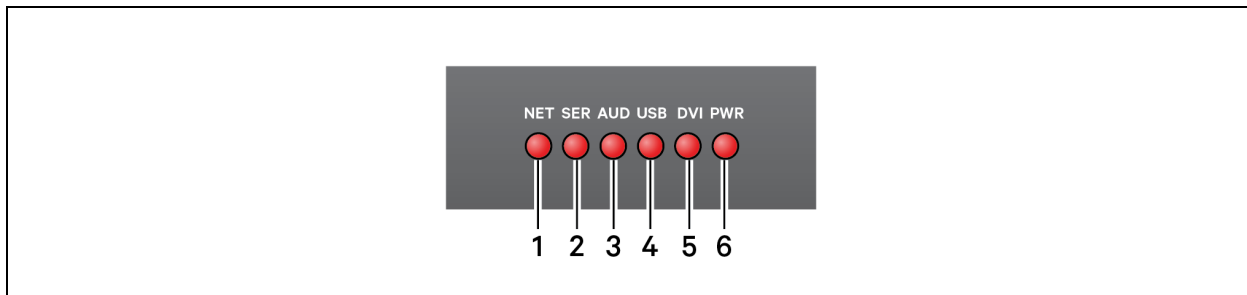

Table 1.9 Display Indicator Descriptions

ITEM	Description
1	NET LED: network link status; a flashing LED indicates a network error. For HMX 6210T transmitters, the NET LED is replaced with a VNC LED. A static lit VNC LED indicates a valid network link on the system or teaming port; a flashing LED indicates a valid VNC network connection.
2	SER LED: serial AUX port status.
3	AUD LED: audio status.
4	USB LED: USB port connection status.
5	DVI LED: video channel status.
6	PWR LED: power status.

## 1.2.6 HMX 5150T/6150T transmitter

HMX 5150T and 6150T transmitters are high-performance, IP-based, KVM transmitters that use the zero-U rack space. The HMX 5150T transmitter supports DVI-D, DisplayPort and VGA video connections with a resolution of 1920 x 1200 at 60 Hz and 1080p. The HMX 6150T transmitter supports either DisplayPort or HDMI video connections with a resolution up to 2K (2560x1600) at 60 Hz. Either transmitter can connect directly to a receiver or via a high-speed network. For additional information on transmitter configuration, see [HMX 5150T/6150T Transmitter on page 18](#).

**Figure 1.9 HMX 5150T DVI-D Transmitter**

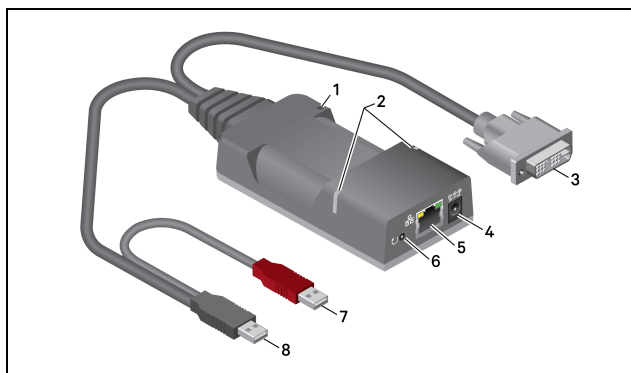

**Table 1.10 HMX 5150T DVI-D Transmitter Description**

Item	Description	Item	Description
1	Cable tie mounting slot.	5	Ethernet port.
2	Status indicators.	6	Reset button.
3	Video input	7	Red USB connector provides power if the external power input is not used.
4	External power input (optional).	8	Black USB connector provides a USB signal plus power if the external power input is not used.



## 2 Installation and Configuration

At this point you should have already completed the installation instructions outlined in the Avocent® HMX High Performance KVM Extender System Quick Installation Guide. For important safety information on your system, visit: [www.vertiv.com/ComplianceRegulatoryInfo](http://www.vertiv.com/ComplianceRegulatoryInfo).

Additional information on your physical configuration options is highlighted in the following sections, as well as basic steps that need to be completed prior to any advanced configuration on your transmitters and receivers. Configuration for the HMX extender system is performed within a web browser-based user interface known as the System Configuration utility. See [System Configuration Utility on page 23](#) for more information on this utility as well as advanced system configuration details.

### 2.1 Configuration Options

The HMX extender system can be configured in a direct connect or matrix configuration. In a direct connect configuration, one transmitter connects directly to one receiver via the system port on each unit. In an unmanaged matrix configuration, a transmitter and multiple receivers can connect directly to a Gigabit Ethernet switch. If you wish to add transmitters to your system, the HMX Advanced Manager server must be added to the system to manage your matrix configuration. See the Avocent® HMX Advanced Manager Software Installer/User Guide for more information.

**Figure 2.1 Example Direct Connect Configuration**

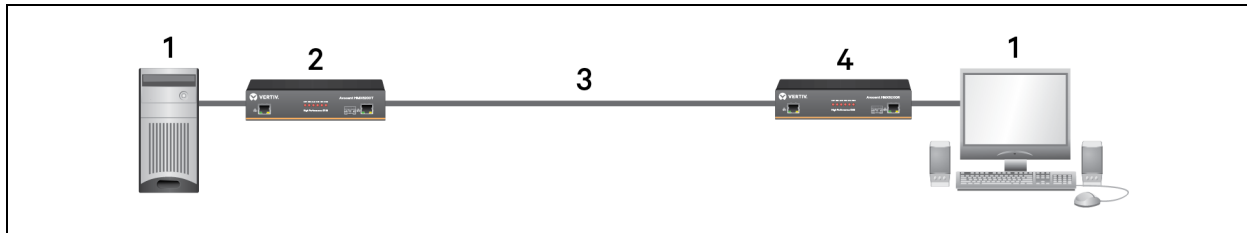

**Table 2.1 Example Direct Connect Configuration Description**

ITEM	Description
1	Remote computer
2	HMX transmitter
3	Link via the system port
4	HMX receiver
5	Local computer

Figure 2.2 Managed Matrix Configuration Example

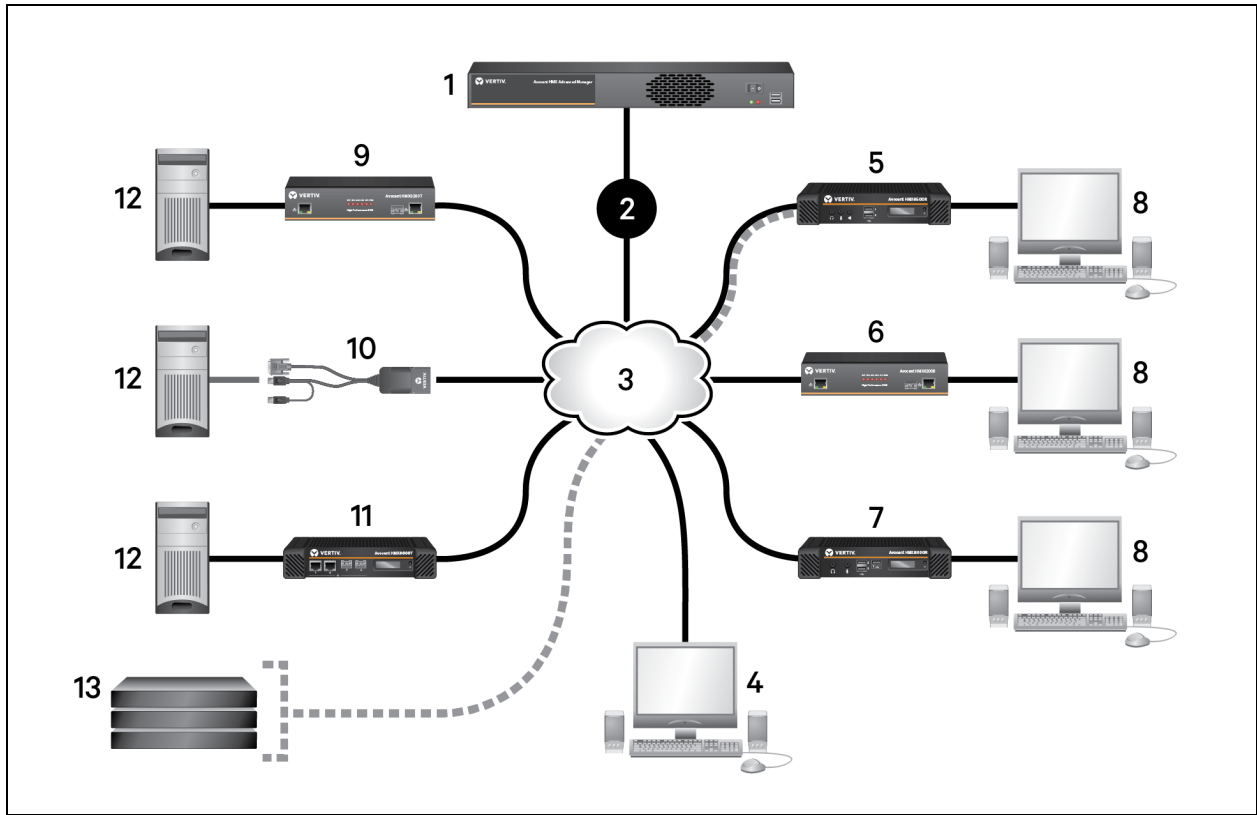

Table 2.2 Managed Matrix Configuration Example Descriptions

ITEM	Description
1	HMX Manage server (hosts the HMX Advanced Manager software)
2	10/100 Mbps link
3	Gigabit Ethernet connection to a switch
4	Administrator computer
5	HMX 6500 receiver
6	HMX 6000 receiver
7	HMX 8000 receiver
8	Local computers
9	HMX 6000 transmitter
10	HMX 5150 transmitter
11	HMX 8000 transmitter
12	Remote computers
13	Virtual machines

## 2.2 System Recommendations

For optimal performance, it is recommended that your HMX extender system has the following:

- Ethernet ports that support Gigabit (1000 Mbps) or faster speeds
- Internet Group Multicast Protocol (IGMP) v2 or v3 support
- Jumbo frame that supports up to 9216 bytes
- Fiber channel or other high bandwidth connections between switches
- Layer 3 switches with full duplex, 1 Gbps up and downstream speeds and multiple dedicated processors Application Specific Integrated Circuits (ASICS)
- For HMX 8000 models, a 10 GB fiber connection is required

## 2.2.1 Factory reset

If the standard settings within your HMX extender system are changed in an installation and you need to change the current configuration, a reset must be performed to restore the transmitters and receivers to the factory default settings before proceeding. This factory reset must also be performed if using an HMX Advanced Manager server to configure your system. Otherwise, the transmitters and receivers in the managed system will not be located.

**To perform a factory reset:**

**NOTE: A factory reset can also be performed from the System Configuration utility. For more information, see [System Configuration Utility on page 23](#).**

1. Ensure the extender you are resetting is turned on.
2. On the extender front panel, locate the small hole that houses the recessed reset button.
3. For HMX 5000 and 6000 units, insert a narrow tool such as a straightened paper clip into the hole, then press and hold it while removing the power cord. Re-insert the power cord and then release the reset button. Five of the front panel device status indicators quickly flash nine times to indicate a successful reset.

-or-

For HMX 6500 units, press and hold the button next to the front panel OLED screen until the indicator turns blue and the OLED screen displays that the unit is in factory reset mode. Then use a narrow tool such as a straightened paper clip to press and release the recessed button on the front panel to turn the unit off. Wait 10 seconds and press the button again to turn the unit back on.

-or-

For HMX 8000 units, use a narrow tool such as a straightened paper clip to press and hold the recessed reset button until the indicators turn blue. Indicators will flash red and green before turning blue. Release the reset button. The indicator remains blue as the unit resets itself. The indicator illuminates green when all connections are reset or orange if one of the connections are missing.

**NOTE: You must wait at least 30 seconds after you have released the reset button to safely disconnect power.**

## 2.3 Basic Configuration

After your system is installed and turned on, you may need to re-configure the IP address for your network. In a direct connect configuration, the factory default address may be acceptable for immediate use in your network. However, if you wish to change the default address, this should be the only basic configuration needed to begin using your transmitter and receiver. In an unmanaged matrix configuration, the IP address of the transmitter and each receiver must be specified so the units can locate each other within the HMX extender system. Re-configuring the IP addresses of extenders in a managed matrix configuration is completed in the HMX Advanced Manager software. See the HMX Advanced Manager Software Installer/User Guide for basic configuration procedures. The default port IP addresses are listed in the following table.

**Table 2.3 Default Port IP Addresses**

Port Name	Transmitter Default IP Address	Receiver Default IP Address
Management or VNC port	192.168.1.42	192.168.1.42
System port	169.254.1.33	169.254.1.32
Teaming port	169.254.1.43	169.254.1.42

**To configure the transmitter:**

1. From a web browser on your local computer, enter the transmitter IP address. The default IP address is: <http://169.254.1.33>.

**NOTE: If the IP address of the transmitter is not known, perform a manual factory reset to restore the default IP address.**

2. Log in to the System Configuration utility. The default username is **admin** and the default password is either **password** or left blank.
3. The first time that you log in to the utility using the administrator account, you are required to reset the password. Select *Security* on the left side of the window.
4. Enter your old password, enter your new password twice to verify and click **Save**.
5. Select *System Configuration* on the left side of the window. On the displayed window, enter the name and a description of the transmitter in the applicable fields.
6. Ensure that the Enable System Port checkbox is selected. Then change the IP address to an address in the private IP range 192.168.xxx.xxx.

**NOTE: In an un-managed matrix configuration, the IP address for the system port must be changed before the Teaming port can be used for network connections.**

7. In the System Netmask field, change the netmask to 255.255.255.0.
8. In the System Gateway field, change the System Gateway to an appropriate address.
9. If using a dual-head transmitter, ensure the Enable Management Port checkbox is selected. From a web browser on your computer, enter the IP address of the unit. The default IP addresses are 169.254.1.33 if you are using port 1, or 169.254..1.43 if you are using port 2.

**NOTE: It is recommended that the IP address of this port remains the same. If you wish to change it, use the new address for all dual-head extenders in the system.**

-or-

**If using an HMX 6210T transmitter, ensure the Enable VNC Port checkbox is selected and enter 169.254.1.33 as the IP address.**

10. Depending on the transmitter model, enter the netmask and gateway information of either the Management or VNC port.
11. If using the teaming port, ensure the Enable Teaming Port checkbox is selected. Then, change the teaming port IP address to an address in the private IP range 192.168.xxx.xxx.
12. In the Teaming Port Netmask field, change the netmask to **255.255.255.0**.
13. In the Teaming Port Gateway field, change the Teaming Gateway to an appropriate address.
14. Verify the Enable Video, Enable Audio, Enable USB and Enable Serial data streams are enabled as appropriate.

**NOTE: It is important that the settings in the transmitter and receiver are the same. If one option is enabled on the transmitter, but disabled on the receiver, the data stream remains disabled.**

15. If you selected the Enable Serial checkbox, enter the baud rate, data bits, stop bits and parity information.

16. Click *Update Now*.

**To configure the receiver:**

1. From a web browser on your local computer, enter the receiver IP address. The default IP address is: <http://169.254.132>.

**NOTE: If the IP address of the receiver is not known, perform a manual factory reset to restore the default IP address.**

2. Log in to the System Configuration utility. The default username is **admin** and the default password is either **password** or left blank.
3. The first time that you log in to the utility using the administrator account, you are required to reset the password. Select *Security* on the left side of the window.
4. In the appropriate fields, enter the old password. Enter your new password twice to verify and click *Save*.
5. Select *System Configuration* on the left side of the window. On the displayed window, enter the name and a description of the receiver in the appropriate fields.
6. Ensure that the Enable System Port checkbox is selected. Then change the IP address to an address in the private IP range 192.168.xxx.xxx.
7. Change the netmask to **255.255.255.0**.
8. Change the System Gateway to an appropriate address.
9. If using a dual-head receiver, ensure the Enable Management Port checkbox is selected. From a web browser on your computer, enter the IP address of the unit. The default IP addresses are 169.254.132 if you are using port 1, or 169.254.1.42 if you are using port 2.

**NOTE: It is recommended that the IP address of this port remains the same. If you wish to change it, use the new address for all dual-head extenders in the system.**

10. If using the teaming port, ensure the Enable Teaming Port checkbox is selected. Then change the teaming port IP address to an appropriate address in the private IP range 192.168.xxx.xxx.
11. In the Teaming Port Netmask field, change the netmask to **255.255.255.0**.
12. In the Teaming Port Gateway field, change the Teaming Gateway to an appropriate address.
13. Verify the Enable Video, Enable Audio, Enable USB and Enable Serial data streams are enabled as appropriate. Select your applicable keyboard country code.
14. Select the mic (standard) or mic boost (+20 dB) radio button, depending on the type of microphone used in your system.
15. Configure the transmitter IP address details in the Target Transmitter Unit Settings section.
  - a. In the IP Address field, enter the IP address of the system port on the transmitter providing the video, audio and data streams.
  - b. If the transmitter is configured to use the teaming port, enter the IP address of the transmitter Teaming port in the IP Address 2 field.
  - c. Click the down arrow to expand the transmitter settings.
  - d. Enter the IP address for each of the data streams.
16. Click *Update Now*.
17. In an un-managed matrix (multicast) configuration, follow these steps to configure the multicast settings:
  - a. Log in to the transmitter System Configuration utility and select *System Configuration* on the left side of the window.
  - b. In the Target Multicast Configuration section, enter the appropriate IP address for each video and audio stream. The Multicast IP entries are for the system port and Multicast IP2 entries are for the teaming port.
  - c. Click the up arrow in this section to repeat steps a and b for each receiver.

d. Click *Update Now*.

18. Repeat this procedure for each receiver in your HMX extender system.

For additional information, see [System Configuration Utility on page 23](#).

### 2.3.1 Firmware upgrade

It is recommended that the HMX extender system use the most current firmware version available, and transmitters and receivers are Flash upgradable at any time. Regardless of your configuration, the same firmware version must be used across all units in your system.

In a managed matrix configuration, it is recommended that you use the HMX Advanced Manager software to quickly upgrade the firmware across multiple transmitters and receivers. The HMX 5100 and 5200 extenders are not downgradable, so the HMX Advanced Manager server must be upgraded to the same version as the extenders to be compatible. See the Avocent® HMX Advanced Manager Installer/User Guide for more information on upgrading the HMX Advanced Manager server. If the extender does not operate properly after the HMX Advanced Manager server is upgraded, a factory reset may need to be performed on the extender.

#### To locate the transmitter and receiver firmware version:

1. From a web browser on your local computer, enter the IP address of the extender.
2. Log in to the System Configuration utility using the **admin** default username. Depending on whether you are using the receiver or the transmitter, enter the corresponding password.
3. Select *About* on the left side of the screen. The build number listed under the Main System heading is the current firmware version.

#### To upgrade your firmware:



**WARNING! Ensure that power is not interrupted during the upgrade process. Otherwise, the extender may become inoperable and require you to switch to the backup firmware image to regain operation. To switch to the backup firmware image, move Option Switch 1 on the extender back panel to the On/Down position.**

1. Visit the [HMX Product Page](#). Scroll down to select your model, then click *Documents and Downloads*.
2. Select *Software Downloads* on the left side of the page, then search for the Avocent® HMX High Performance KVM Extender System transmitter and receiver firmware upgrade files.

**NOTE: The remaining steps need to be completed for each transmitter and receiver that you wish to upgrade.**

3. Log in to the System Configuration utility.
4. Select *Firmware Upgrade* on the left side of the screen.
5. Click *Browse* and select the firmware upgrade file you wish to upgrade.

**NOTE: The file contains main and backup firmware images you can choose to upgrade.**

6. Select *Upgrade Now*. The indicators on the extender front panel flash while the upgrade is in process. After the firmware upgrade is complete, the extender automatically reboots.

## 2.4 HMX 5150T/6150T Transmitter

The following procedures are specific to the HMX 5150T and HMX 6150T transmitter.

#### To connect an HMX 5150T or 6150T transmitter:

1. Connect a CAT5, 5e, 6 or 7 cable to the Gigabit Ethernet port on the front of the unit.

2. Connect the other end of the cable either directly to an HMX receiver or to a Gigabit Ethernet switch, as needed.
3. If connecting via a network, repeat steps 1 and 2 for each of the other units.

For configuration information, see [System Configuration Utility on page 23](#).

## 2.4.1 USB and power connections

The HMX 5150T and 6150T transmitters are designed to operate using an optional external power adaptor or it can receive all of its power from the two USB connections. Using the external power adaptor for power allows a remote user to access the host's bootup and BIOS menu, if needed. If you are using the external power adaptor, only the black USB plug needs to be connected. If you are using power from the USB only, then both the black and red USB plugs must be connected.

**NOTE: There is a short interruption in power if the operation switches from one power source to the other.**

**Table 2.4 Power Connections**

Power adaptor	black usb	red usb	description
	x	x	Power is received from both USB connections.
x	x		Power is received from the power adaptor only.
x	x	x	Power is received from the power adaptor. If the power adaptor becomes unavailable, power is switched to the USB connections after a short interruption in power.

## 2.4.2 Status indicators

The two panel indicators on top of the transmitter provide additional operation information. See the following for a description of each.

**Table 2.5 Status Indicators**

Indicator	status	description
Main status indicator	Off	No Power.
	Green	Video, USB and network links are operating.
	Orange	Operating, but video, USB and/or network link is missing.
	Red	Consistent - unit has failed; reboot. Intermittent - Unit is booting.
	Green/Red flashing	Unit is in backup mode.
	Blue	Factory reset activated.
	Red/Blue flashing	Unit is in upgrade mode.
	Fast Green flash	Unit is in identify mode.
Network indicator	Orange	Off: No link. On: Link established.
	Green	Off: No link. Flashing: Network activity. On: Quiescent link.

### 2.4.3 Restoring a firmware backup

The transmitter retains a backup image of the previous firmware version. After the image is restored, you need to load the upgrade file with the new primary image. See [Performing an upgrade below](#).

#### To restore the backup firmware image:

1. Turn on the transmitter.
2. Using a straightened paper clip, press and hold the recessed reset button for approximately 10 seconds until the main status indicators flash green and red.
3. Release the reset switch. When the backup is complete, the transmitter's main status indicators continually flash green and red.

### 2.4.4 Performing an upgrade

HMX 5150T and 6150T transmitters are flash upgradeable. However, for larger installations, it is recommended that you use the HMX Advanced Manager software to upgrade multiple units at a time.

**NOTE: Upgrades must be performed on transmitters and receivers at the same time. A mixed firmware operation is not supported.**



**WARNING! During the upgrade process, ensure that power is not interrupted. This may leave the transmitters in an inoperable state. If the upgrade process is interrupted and fails, it may be necessary to switch to the backup firmware image in order to regain operation.**

#### To upgrade a single HMX 5150T or 6150T unit via a local computer:

1. Download the latest upgrade file from [HMX extender download page](#).
2. Connect a CAT5, 5e, 6 or 7 network cable to the network port on the front of the unit.
3. Connect the other end of the cable directly to the network port of your computer.



4. Open a web browser on your computer and enter the IP address of the unit to be upgraded.
5. From a web browser, select the *Firmware Upgrade* tab.
6. Select *Choose File* and locate the downloaded upgrade file.
7. Verify the file is for the unit being upgraded and choose either *Main* or *Backup*.
8. Click *Upgrade Now*. The status indicators on the transmitter flash while the upgrade is in progress. In less than one minute, the indicators stop flashing, the unit reboots and the upgrade process is complete.

## 2.4.5 Configuring the HMX 6150T transmitter

For the HMX 6150T transmitter, you can configure the transparent high-speed USB, digital audio and USB digital audio via either HDMI or Display Port (DP).

### To configure an HMX 6150T transmitter via a local computer:

1. Connect a CAT5, 5e, 6 or 7 network cable to the network port on the front of the unit.
2. Connect the other end of the cable directly to the network port on your computer.
3. Open a web browser on your computer and enter the IP address of the unit to be upgraded.
4. To enable or disable transparent high speed USB:
  - a. From the web browser, select the *USB Setting* tab
  - b. Check or uncheck *Disable high speed USB*
5. To configure the digital audio:
  - a. From the web browser, select the *System Configuration* tab
  - b. Select *Audio 1 for digital USB audio* or *Audio 2 for HDMI or DisplayPort audio*.

## 2.4.6 Factory resetting the HMX 5150T and 6150T transmitters

A factory reset returns the transmitter to the default configuration.

### To reset to factory settings:

1. Turn on the transmitter.
2. Use a straightened paper clip to press and hold the recessed reset button. The status indicators immediately turn red.
3. Release the reset switch at the appropriate time, as shown in the following table.

**Table 2.6 Release Time Indicators**

function	release time	indicators
To reboot to the primary firmware version	Less than 10 seconds	Red
To boot to the backup firmware	10 to 14 seconds	Green and Red flashing
To restore factory settings and reboot	More than 15 seconds	Blue

This page intentionally left blank

## 3 System Configuration Utility

After installing your HMX extender, log in to the System Configuration utility to perform basic configuration of your extenders. Additional general operations and advanced configuration tasks can also be performed through this streamlined user interface. Although the System Configuration utility is the primary interface used to make changes to your extenders, there is an additional On-Screen Display (OSD) interface located on HMX receivers.

**NOTE:** For the steps to log in to the utility, see [Basic Configuration](#) on page 15. For more information on the OSD interface, see the [On-Screen Display](#) on page 61.

### 3.1 General Operations

After initial configuration, other general tasks can be performed through the System Configuration utility to customize and streamline common system operations.

**NOTE:** The following procedures are performed the same way regardless of whether you are using a transmitter or receiver. Choose the extender you wish to update, then log in to the System Configuration utility. All steps begin on the main System Configuration window.

#### 3.1.1 Locating an extender within a rack or data center

If you have a complex HMX extender system configuration, it may be difficult to quickly identify a specific transmitter or receiver in a rack or a data center. The System Configuration page within the System Configuration utility provides options to activate the front panel LEDs or OLED to assist with identifying the extender you are trying to locate.

**To activate the front panel LEDs:**

1. Select *System Configuration* on the left side of the page.
2. Select *Identify Unit (short)* to prompt the front panel LEDs to flash for five seconds.

-or-

Select *Identify Unit (long)* to prompt the front panel LEDs to flash for one hour. This setting can be overridden at any time by selecting the short option.

#### 3.1.2 Enabling system messages

Through the System Configuration utility, you can choose to receive general status information about your HMX extender system, including any error messages that may occur.

**To enable system messages:**

1. Select *System Messages* on the left side of the page, then select the Enable system messages checkbox.
2. If you enable the Send system messages to remote Log Server checkbox, also provide the IP address of a suitable remote server.

**NOTE:** The User Datagram Protocol (UDP) is used for all Syslog traffic.

3. Enable the Store system messages in unit checkbox to keep system messages within the memory of the extender. If you wish to view the messages or delete them, click the appropriate button.
4. Click *Update Now* to apply your settings.

### 3.1.3 Enabling HMX Advanced Manager server control

If you wish to have more than one transmitter within your HMX extender system, the HMX Advanced Manager server must be added to the system to manage your matrix configuration. You must also ensure that each extender is set to allow the HMX Advanced Manager server to take control of it.

**To enable HMX Advanced Manager server control:**

1. Select the link to the HMX Advanced Manager on the left side of the page.
2. On the displayed page, enable HMX Advanced Manager server control.

### 3.1.4 Recording bandwidth statistics

The HMX extender system provides bandwidth statistics that can be recorded, transferred and used for system optimization and troubleshooting, if needed. With the System Configuration utility, you can choose the type of bandwidth statistics you wish to gather from an extender system port and then transfer it to a graph. In configurations where both the system and teaming ports are used, only the system port is measured and shown on the graph, but the illustrated bandwidth is the same for both ports. For example, if the statistics graph shows 500 MB of bandwidth on the system port, then it is assumed that there is also 500 MB of bandwidth on the teaming port. In this scenario, the total bandwidth across ports is 1 GB.

**To generate a statistics graph:**

1. Select *Statistics* on the left side of the page, then select the Enable collection of bandwidth statistics checkbox.
2. A pop-up box appears and allows you to select what data bandwidth aspects you wish to show on the graph.
3. Click *Submit* to generate a pop-up graph of the information.

### 3.1.5 Rebooting and resetting the extender's factory default

If the power to your HMX extender needs to be turned off and turned back on again, a reboot can be performed via the extender System Configuration utility. Also, if a factory reset is needed and does not have to be manually performed from the extender front panel, the reset can be performed in the utility as well.

**To perform a standard reboot on your extender:**

Select *Reboot* on the left side of the page, then click *Reboot* on the displayed page.

**To factory reset and reboot your extender:**

1. Select *Reboot* on the left side of the page, then select the Perform Factory Reset checkbox.
2. Click the *Reboot* button at the bottom of the page.

## 3.2 Advanced Transmitter Configuration

Although basic configuration of your transmitter should already be complete, advanced procedures are available via the System Configuration utility that allow you to further customize your transmitter video, USB and security settings. If you are using an HMX 6210T transmitter within your extender system, additional unique procedures must also be performed to utilize the VNC port on the front panel.

**NOTE: Log in to the transmitter System Configuration utility before completing the following procedures. All steps begin on the main System Configuration page.**

### 3.2.1 Configuring transmitter video

Options are available that allow you to control and configure the video transmitting across the HMX extender system.

**NOTE: When using an HMX extender system with dual-head extenders linked via two Gigabit links with sufficient bandwidth available, there may be no need to alter the default settings on the Video Configuration page of the System Configuration utility.**

The following best practices are recommended when configuring transmitter video settings:

- If moving video images are shown frequently on an HMX 6210T transmitter, lower the Frame skipping percentage and reduce the color depth.
- If video screens in your system are relatively static, increase the Background Refresh interval and the Frame skipping percentage.
- As you apply each setting, you may wish to view video images with typical adjustments.

#### To configure transmitter video settings:

1. Select *Video Configuration* on the left side of the page, then adjust the following settings to meet the needs of your system.
  - Peak bandwidth limiter percentage: Select the percentage of bandwidth (0-95%) allowed for the transmitter to prevent the transmitter from utilizing too much network capacity when sending video and data over the IP network.
  - Background Refresh: Select the frame rate to control bandwidth used by the transmitter when sending the complete video image in the background. Any rate higher than 32 frames reduces bandwidth. The transmitter also sends the affected changes in the image.
  - Color Depth (HMX 6210T transmitter only): Select the color depth that best applies to your system.
  - Enable Anti Dither: Enable this checkbox to reduce the effects of dithering. While dithering improves images by diffusing and altering pixel colors between video frames, it slows down system performance. The Anti Dither feature ignores color dithering, which increases the frame rate and eliminates unnecessary network traffic.
  - Default DDC options: Disable the Use Default DDC checkbox to use the EDID reported by the monitor that is connected to the receiver. Enabling the checkbox, however, activates the Choose Default DDC drop-down list, allowing you to select from a range of preset video resolutions.

**NOTE: After a resolution is selected, the transmitter only supports that video resolution. All listed resolutions are single-link DVI with a maximum pixel clock of 165 MHz and a refresh rate of 60 Hz.**

- Hot Plug options: Select the Enable Hot Plug Detect option to send a message to the graphics card of the computer attached to the transmitter every time the monitor located at the receiver is changed. Select the length of time that a hot plug detect signal is applied from the options in the Period of Hot Plug Detect signal drop-down list. Most graphics cards operate efficiently at the 100 ms default.
- Frame skipping percentage: Select the percentage (0-100%) of captured video frames that can be skipped to reduce the overall bandwidth consumed by the system. This process works best for video sources that either infrequently update or frequently update, but do not require high fidelity.
- Compression: From the drop-down list, choose the compression method you wish to use for video transmission:

Select *Pixel Perfect* to use the standard HMX extender system RLE compression scheme.

Select *Adaptive* to use the standard compression and also guarantee the frame rate.

Select *Smoothest Video* to force the maximum compression.

Select *Advanced* to choose a fixed compression mode and select the amount of compression that accompanies the AVCT scheme. The compression level determines how much the system speed is increased.

2. Select *Update Now* to apply your settings.

### 3.2.2 Viewing video snapshots and reports

Snapshots of connected video feeds, as well as reports of detected video resolutions and color depths for your HMX extender system, can be generated from the System Configuration page on the transmitter.

#### To generate a snapshot and report about connected video feeds:

1. Select *System Configuration* on the left side of the page.
2. Select *Thumbnail* at the bottom for the video feed snapshot and resolution/color depth report.
3. Select the *Refresh Thumbnail* button to update the information.

### 3.2.3 Configuring the transmitter USB and security settings

The local transmitter System Configuration utility allows you to configure specific USB and security settings within the HMX extender system.

#### To configure transmitter USB settings:

1. Select *USB Setting* on the left side of the page.
2. Select the Enable Dummy Boot Keyboard checkbox if you want to ensure that a keyboard is always reported when the computer is turned on.

**NOTE: This dummy boot keyboard is virtual and uses one of the USB endpoints. You must disable this option if all endpoints are required elsewhere for other USB devices.**

3. Select the Disable Hi-Speed checkbox to force the system to run at the low/full USB speed of 12 Mbps. This forces USB 2.0 high speed devices to adapt to a lower rate.
4. From the Hub Size drop-down list, select the amount of USB hubs to be supported by the transmitter.
5. From the Reserved Port Range drop-down list, select the number of ports to reserve for devices. The devices are assigned the reserved ports from the receiver.

**NOTE: Use this list for devices that must always report to the same USB port number in order to assist the USB driver with easily locating the device. By default, a zero value disables this option, but if you choose to change it, the dummy boot keyboard must be disabled.**

6. Click *Update Now* to apply your changes.

#### To configure transmitter security settings:

1. Select *Security* on the left side of the page.
2. Click the desired radio button next to the USB and Control Encryption fields to set the encryption frequency.

**NOTE: Data passed across the system can be USB data or control data (video data is not encrypted).**

3. If you wish to require your password to open configuration pages, select the Secure web pages with password checkbox.
4. In the event that your password needs to be changed, select the Change password checkbox.
5. Enter the old password once, then enter the new password twice to verify.
6. Click *Save* to confirm your changes.

### 3.2.4 Configuring the HMX 6210T transmitter

The HMX 6210T transmitter contains a VNC server that allows you to transmit a low-bandwidth version of the video output across standard networks to authorized remote viewers. The VNC link can either be made over the same network as the main HMX extender output or via a separate one. Basic set up and configuration on the transmitter front panel VNC port was completed earlier in this guide. However, further configuration of the VNC port is completed through the use of a third party VNC Viewer program running on a computer or mobile device. By utilizing a VNC viewer, up to sixteen remote users can log in over standard networks to view the output of the HMX 6210T transmitter.

**NOTE: Instructions on using a third party VNC viewer vary depending on which one you choose. See the help sections or other documentation supplied by the specific program if you need more information.**

#### Selecting a third party viewer

If you do not already have a VNC viewer, you can choose one of the following options:

- Download the latest VNC viewers from the RealVNC web site. If using a tablet or smartphone, you can download a viewer from the app store.
- Download a Microsoft® Windows® VNC viewer from the transmitter.
- Run a Java version of the VNC viewer in your web browser.

**NOTE: The V5 viewers support a newer 256-bit encryption technique. However, virtual media functionality is not supported in a V5 viewer.**

#### To download a Windows VNC viewer from the transmitter:

1. Connect the transmitter to an IP network where a computer is available on the same subnet.
2. Open an internet browser and enter **http://192.168.1.42** as the default local IP address of the transmitter.
3. After the welcome page, click the *Download the Windows VNC Viewer from Unit* link.
4. Open the executable file and follow the on-screen instructions.

#### To use the Java VNC viewer:

1. Connect the transmitter to an IP network where a computer is available on the same subnet.
2. Open an internet browser and enter **http://192.168.1.42** as the default local IP address of the transmitter.
3. Click the link *Connect using built-in Java VNC Viewer*. The Java viewer loads and runs inside the browser.

#### Using the Virtual Media feature

On HMX 6210T transmitters, an additional virtual media (VM) feature can be used if you need to make information available remotely. Disk drives, single files or collections of files and folders up to 2 GB in size can be posted as read-only files on the host computer through the VNC viewer. To use the virtual media feature, a VM link must be made from the HMX 6210T transmitter and a host computer USB port. Additional instructions are available within your specific VNC viewer.

**NOTE: File transfers in this configuration move in one direction only, from the viewer to the host computer. This feature is not supported by Apple® Mac® systems.**

## 3.3 Advanced Receiver Configuration

Although basic configuration of your receiver should already be complete, advanced procedures are available via the System Configuration utility that allow you to further customize your receiver video, USB and security settings.

**NOTE: Log in to the receiver System Configuration utility before completing the following procedures. All steps begin on the main System Configuration page.**

### 3.3.1 Configuring receiver video

If your system is using dual-head extenders, you can verify that the monitor connected to the receiver can support and properly display the chosen video resolution.

#### To verify the connected monitor supports a chosen resolution:

On the System Configuration page, select the Enable Video Compatibility Check checkbox to prompt a verification using the EDID reported by the computer graphics card. An error message is displayed and no connection is made if the monitor cannot support the video resolution.

By default, receivers are configured for Fast Switching, which means that the extender video retains the same frame rate at either 50 or 60 Hz, depending on which resolution was displayed first. If you prefer to adjust this setting, the Match Frame Rate option follows the source frame rate (50 Hz) and causes any variation to automatically return to that rate, even if the video resolution does not change. For example, if you have a receiver switching between 1920 x 1080 at 60 Hz and 1920 x 1080 at 50 Hz, enabling the Match Frame Rate option changes the frame rate back to 50 Hz every time you switch. For your specific configuration, 60 Hz may be the frame rate that you prefer. By enabling the Force Video Refresh Rate to 60 Hz checkbox, the receiver frame rate is held at 60 Hz regardless of the video input frame rate.

#### To select your preferred video frame rate:

Select *System Configuration* on the left side of the page, then select the Fast Switching (50 or 60 Hz frame rate) or the Match Frame Rate (50 Hz) radio button.

-or-

Enable the Force Video Refresh Rate to 60 Hz checkbox, which prevents the previous video switching options from being altered.

### 3.3.2 Configuring receiver USB and security settings

The local receiver System Configuration utility allows you to configure specific USB and security settings within the HMX extender system.

#### To configure receiver USB settings:

1. Select *USB Setting* on the left side of the page.
2. Select each of the following checkboxes if you wish to enable the setting:
  - a. Select to allow HIDs to restrict supported USB devices to keyboards and mice only, and disables all other types of USB devices.
  - b. Since isochronous USB devices are not supported in an HMX extender system, select to receive Isochronous Endpoint OSD Alerts if one is connected.
  - c. Select to allow an isochronous endpoint to be attached to the system to allow control information to be exchanged with that device.
3. In the Port Reservation section, map the four receiver USB connections to a specific USB port reserved on the transmitter.
4. In the Advanced features section, select the Enable advanced features checkbox if you wish to add information to this area of the page. This section allows you to enter special codes that may be needed to resolve an issue if a USB device fails.
5. Click *Update Now* to apply your changes.

#### To configure receiver security settings:

1. Select *Security* on the left side of the page.



2. Data passed across the system can be USB data or control data (video data is not encrypted). Click the desired radio button next to the Encryption field.
3. If you wish to require your password to open configuration pages, select the Secure web pages with password checkbox.
4. If your password needs to be changed, select the Change password checkbox.
5. Enter the old password once, then enter the new password twice to verify.
6. Click Save to confirm your changes.

This page intentionally left blank

## 4 Configuring the HMX 6500 Receiver

All configuration for an HMX 6500 receiver must be done via the HMX Advanced Manager. The HMX 6500 receiver must be added to the same network as the HMX Advanced Manager. To be added to the network, each HMX 6500 receiver must be in its factory default mode so that it can communicate with the HMX Advanced Manager.

For more information on resetting an HMX 6500 receiver to its factory defaults, see [Factory reset on page 15](#).

### 4.1 Network Connections

The HMX 6500 unit has two SFP ports on its rear panel to support separate fiber or copper network links.

Additionally, the unit also supports a virtual machine (VM) network link up to 1 GB via an RJ45 network port on the rear of the unit.

**NOTE:** The RJ45 network connects to a corporate network to access the HMX Advanced Manager and VM targets.

**Figure 4.1** Creating a Network Connection

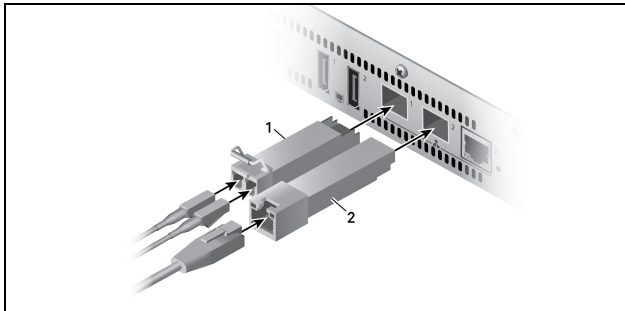

**Table 4.1** Creating a Network Connection Descriptions

ITEM	description
1	Fiber SFP module
2	Copper/CATx SFP module

**To make a physical network connection:**

1. Insert the appropriate fiber or copper SFP module into one or both of the SFP ports on the rear of the unit.
2. Using an appropriate cable, connect your switch to the appropriate SFP module.

**NOTE:** For fiber connections, close the latch on the SFP module connector to lock the cable in place.

**To make a VM connection:**

Using an appropriate CATx cable, connect your network switch to the RJ45 port on the rear of your HMX 6500 unit.

### 4.2 OLED Screen

Once configured, your HMX 6500 should operate automatically. The OLED screen on the front of the unit displays information. Press the control button on the top right of the screen to switch the displayed information.

**Figure 4.2 OLED Screen Examples**

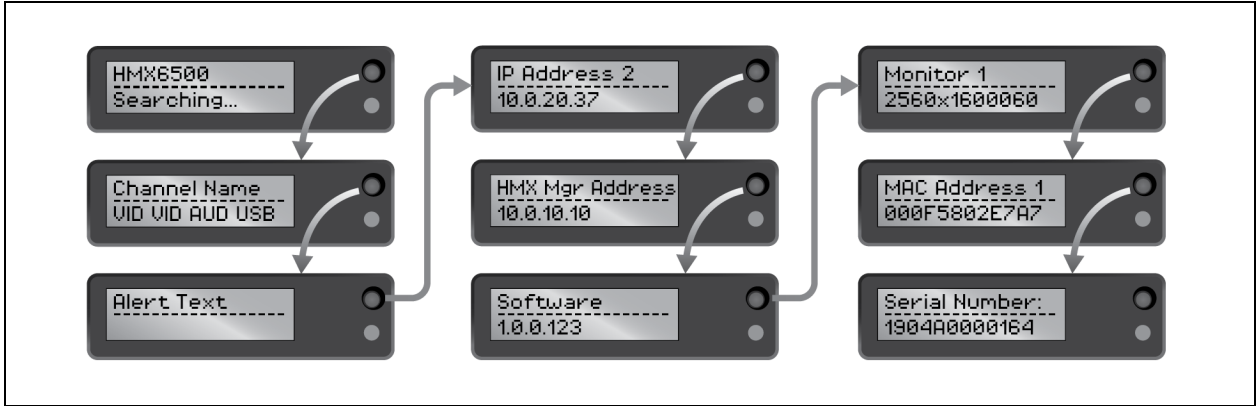

**Table 4.2 OLED Screen Descriptions**

Screen	Description
Status	Indicates the connection status of the HMX 6500 unit - Searching, Connecting or Connected.
Connection	Displays the name of the current channel and the peripherals that are connected and operating.
Alert	If an alert is triggered, displays the alert with an explanation. Once shown, the Status page returns.
IP Address	Displays the IP addresses of each of the three network ports. Press the button to switch among the ports.
AIM Address	Displays the AIM server's address, if applicable.
Software Version	Displays the current software version of the unit.
Display Resolution	Displays the resolution of each connected monitor. Press the button to switch between monitors, if applicable.
MAC Address	Displays the MAC addresses of each of the three network ports. Press the button to switch among the ports.
Serial Number	Displays the serial number of the HMX 6500 unit.

### 4.2.1 Front panel indicator

Each HMX 6500 unit has a single indicator light located below the control button to display the status of each unit.

**Table 4.3 Indicator Light Status Descriptions**

Color	Description
Off	No power.
Solid green	All services are running.
Solid amber	The unit is running, but video, USB or a network link is missing or not connected.
Solid red	Booting before the processor loaded or failed.
Solid blue	The factory reset mode is active.
Flashing red/green	Booting into factory recovery mode.
Flashing green/blue	Upgrade mode is active.
Fast flashing green	Identify mode is active.

## 4.2.2 Viewing the configuration page

Once the HMX 6500 unit has been added to the network, you can view its configuration page by browsing to its IP address. Press the small button on the OLED screen on the front of the unit until the IP address displays.

**NOTE:** Depending on which network port is used, IP address 1 or IP address 2 displays.

This page intentionally left blank

## 5 Configuring the HMX 8000 system

Each HMX 8000 unit hosts an internal set of web pages that contain its configuration details and settings. Using a computer connected to the same network as each HMX 8000 unit, you can configure each unit. You can also access the configuration page by pressing **CTRL + ALT + C** on the console attached to each HMX 8000 unit.

### To configure an HMX 8000 unit from its web page:

From your computer's web browser, enter the IP address of the HMX 8000 unit.

The default IP addresses when using SFP port 3 are:

- 169.254.1.33 for the transmitter.
- 169.254.1.32 for the receiver.

The default IP addresses when using SFP port 4 are:

- 169.254.1.43 for the transmitter.
- 169.254.1.42 for the receiver.

-or-

You can discover the IP address by pressing the small button on the front panel next to the OLED screen.

**NOTE:** Performing a factory reset will restore the IP addresses back to their default values. For more information, see [Factory reset on page 15](#).

### 5.1 General Information

Click the *General* tab to view and configure general information about your unit.

The information in the following table is applicable for both transmitters and receivers.

**Table 5.1 General Information Descriptions**

item	description
Device Type	Displays whether the unit is a transmitter (TX) or receiver (RX).
Device Name	Displays the device name.
Device Description	Displays the (optional) description of the device.
Device Location	Displays the (optional) location of the device.
Current Software Version	Displays the version of the current software installed on the device.
Serial Number	Displays the device serial number.
Board Revision	Displays the revision number of the main circuit board of the device.
Device Model	Displays the model number of the device.
Date and Time	Displays the current date and time used by the device.
Uptime	Shows how long the device has currently been running.
Identify Device	Click this button to cause the indicator on the front panel of the device to flash. This helps to identify the device when multiple units are installed in the same area. A pop-up dialog displays showing all relevant identification details. Click <i>Cancel</i> to stop the identification process, or click <i>OK</i> to close the pop-up.

## 5.2 UI Settings

Click the *UI Settings* tab to view and configure user interface (UI) settings.

**Table 5.2 Transmitter UI Settings Descriptions**

parameter	description
Front Panel Timeout	Determines how many seconds of inactivity before the front panel display goes blank.
LED Brightness	Determines the brightness of the front panel LED indicator.

**Table 5.3 Receiver UI Settings Descriptions**

parameter	description
OSD Notification Position (plus Timeout)	Determines the location and persistence of notifications displayed on screen.
OSD Banner Position (plus Timeout)	Determines the location and persistence of banners displayed on screen.
OSD Timeout	Determines how many minutes of inactivity before the OSD screen closes.
Front Panel Timeout	Determines how many seconds of inactivity before the front panel display goes blank.
LED Brightness	Determines the brightness of the front panel LED indicator.

## 5.3 Presets

Click *Presets* to view the details and connection status for the current channel preset being used by the receiver.

**NOTE:** This page is only available on HMX 8000 receivers.



Each row details one type of connection that has been made. It lists the output port on the receiver and the source port from the connected transmitter. It also displays the name of the connected device. The icon in the Status column displays whether it is connected to the source or not.

## 5.4 Ports

Click the *Ports* tab to view and configure Ports on the device.

There are four sets of ports on a transmitter and three on a receiver. Serial ports are not available on a receiver.

- Video
- Audio
- USB
- Serial

Click the appropriate icon on the right of the page to access that port type's information.

### 5.4.1 Video ports

Displays information about the two video ports located on the transmitter or receiver.

**Table 5.4 Transmitter Video Ports Descriptions**

parameter	description
Enabled	Displays whether each video port is enabled or disabled.
Connected	Displays if the functioning host video drivers are connected to the two video ports.
EDID Source	Displays the EDID mode currently being used by the two video inputs.
Advanced	Click Advanced to display a pop-up for the two video feeds. Details include: Compression, Bits per Color, Frame Skipping, Background Refresh and whether the Magic Eye Option is enabled or disabled.
Multicast	Displays all the video multicast IP addresses that have been configured.

**Table 5.5 Receiver Video Ports Descriptions**

parameter	description
Enabled	Displays whether each video port is enabled or disabled.
Connected	Displays if the functioning host video drivers are connected to the two video ports.
EDID Source	Displays the EDID mode currently being used by the two video inputs.
Compatibility Check	Displays whether video compatibility between the source and display device is enabled. When enabled, it prevents displaying resolutions the monitor doesn't support.
Frame Rate Switching	Displays the strategy used for the frame rate when switching resolutions. Force 60 - The frame rate is always forced to 60 Hz. Retain - Retains the current frame rate when switching to a different resolution. Auto - The frame rate always switches to match the mode it is connected to.

### 5.4.2 Audio Ports

Displays information about the audio ports located on the transmitter.

**Table 5.6 Transmitter Audio Ports Descriptions**

parameter	description
Enabled	Displays whether the audio ports are enabled or disabled.
Connected	Displays if devices are connected to the audio ports.
Quality Mode	Displays a measure of the audio quality. By default, this value is set to Auto.
Multicast	Displays all the audio multicast IP addresses that have been configured.

**Table 5.7 Receiver Audio Ports Descriptions**

parameter	description
Enabled	Displays whether the audio ports are enabled or disabled.
Connected	Displays if devices are connected to the audio ports.
Gain	Determines the microphone gain/amplification level. None - No device is connected to the port. Mic - Standard gain for normal microphone devices. Mic boost - 20 dB volume boost for microphone input devices.

### 5.4.3 USB Ports

Displays information about the USB ports located on the transmitter or receiver.

On the receiver, information is displayed for ports 2-5. USB port 1 on the receiver is transparent and its devices are not listed.

**Table 5.8 Transmitter USB Ports Descriptions**

parameter	description
Enabled	Displays whether the USB ports are enabled or disabled.
Connected	Displays if devices are connected to the USB ports.
Transparent USB Enabled	Offers a different implementation of USB support from emulated USB. When enabled, it allows additional devices to be used that would not function with emulated USB.
Speed	Displays the USB speed mode currently in use by the host computer's USB port. Settings are High or Full.
Present Boot Keyboard	When enabled, the transmitter reports a virtual dummy boot keyboard to the attached computer to ensure the keyboard is always reported when the computer boots. The dummy boot keyboard uses one of the 13 USB endpoints. If all 13 endpoints are required for other USB devices, or if a KVM switch only supports two HID devices, this feature can be disabled.
Max Hub Size	You can whether the transmitter reports as a seven- or a 13-port USB hub. Some USB hosts can only support seven-port USB hubs. If this option is set to seven, then only seven USB devices are supported by the computer.

**Table 5.9 Receiver USB Ports Descriptions**

Parameter	description
HID Only	When enabled, all ports are limited to supporting Human Interface Devices (HID) only. Examples are keyboards and mice.
Enable Isochronous Devices	When enabled, a dedicated portion of the USB bandwidth is reserved for real-time data transfers, which must be sent at a constant rate.
Connected Devices	Displays all connected devices with manufacturer and model details, as reported. Click Details to view more information, such as device type, protocol version, speed and maximum power consumption.

## 5.4.4 Serial Ports

Displays information about the serial port located on the transmitter. These options are configurable via the HMX Advanced Manager server.

**Table 5.10 Serial Ports Descriptions**

Parameter	Description
Enabled	Displays whether the serial port is enabled or disabled.
Connected	Displays if a valid serial device is connected to the serial port.
Speed	Displays the baud rate of the connected serial device.
Data Bits	Displays the number (5, 6, 7 or 8) of data bits.
Stop Bits	Displays the number (1 or 2) of stop bits.
Parity	Displays the parity checking (none, odd or even).

## 5.5 Network

Click the Network tab to view and configure network information for each of the ports on the transmitter or receiver.

The information in the following table is applicable for both transmitters and receivers.

**Table 5.11 Network Descriptions**

parameter	description
Socket	Displays each operational network socket. Sockets 3 and 4 are determined by the SFP modules.
MAC Address	Displays the unique, fixed hardware identification number for each port.
Link Up	Displays if the link state of this network is up. It should be up if the device is connected to a functioning network.
IP Address	Displays the IP address of the network interface. This parameter is not configurable. The device functions in a network zero-config state, which does not require the setting of a static IP address.
Netmask	Displays the netmask of the network interface. This is not configurable. The device functions in a network zero-config state, which does not require the setting of a static netmask.
Gateway	Displays the gateway address of this network interface. This is not configurable. The device functions in a network zero-config state, which does not require the setting of a static gateway.
DHCP Enabled	When enabled, the corresponding port derives its IP Address, Netmask and Gateway details from the DHCP server specified in the DHCP Server Address field.
DHCP Server Address	Displays the address of a valid DHCP server (which can be the HMX Advanced Manager server) to be used when the DHCP server is enabled.
Rout of Last Resort	In a multi-interface device such as this, the selected interface is used as the default whenever it is unclear which interface should be used for network traffic. This is determined via the HMX Advanced Manager server.
Routing Table	Click <i>Details</i> to show the routing table entries corresponding to the network interface. In it are the destination address, gateway and netmask for the routes to particular network destinations.
DNS Servers	Displays the DNS server addresses obtained via DHCP.
NTP Enabled	When enabled, the unit derives its time and date information from a suitable NTP server.
NTP Servers	Displays NTP server addresses obtained via DHCP.
NTP Key ID	Displays the ID of the key used for secure NTP.
NTP Key Value	Displays the value of the key, in a hexadecimal string, used for secure NTP.
HMX Advanced Manager Enabled	Displays if server management is enabled.
HMX Advanced Manager Servers	Displays management server addresses that have been manually configured.

## 5.6 Diagnostics and Statistics

Click *Diagnostics* to view and configure various diagnostics and statistics.

There are four sets of diagnostics and statistics on the device.

- Log Settings
- Network Statistics
- Video Port Status
- Video Port Statistics

Click the appropriate icon on the right of the page to access the desired page.

### 5.6.1 Log Settings

Click the *Log Settings* icon to view and configure diagnostic log settings.

The information in the following table is applicable for both transmitters and receivers.

**Table 5.12 Log Settings Descriptions**

parameter	description
Capture diagnostics to download	Request generation of a diagnostics dump file. Downloaded by the host computer's browser, this is an encrypted diagnostics file that can be used to diagnose and fix issues.
Remote Support	When using a remote server, this option determines which port will be used. Multiple options are offered in case one or more ports are blocked by your firewall.
Logging Severity Level	Defines the level of messages that will be logged. Level 5 (Notice: normal but significant condition) is the default setting. The HMX 8000 supports levels 1 to 7. Choosing levels 6 (Informational) or 7 (Debug) will cause a larger number of lesser events to be logged, with a potential impact to overall performance. These levels should only be used if working with the support team to diagnose a specific issue.
Remote Logging Enabled	When enabled, log files are sent to the selected remote logging address.
Remote Logging Address	The IP address of the local network syslog server where the remote log files are sent.
Log File	Click to download the log file to the local host computer.

## 5.6.2 Network Statistics

Click the *Network Statistics* icon to view current communication statistics and create graphs in real time.

The information in the following table is applicable for both transmitters and receivers.

**Table 5.13 Network Statistics Descriptions**

Parameter	description
Capture and Graph Statistics	When enabled, a real-time graph is created plotting received bytes alongside received packets.
Show Legend	When Capture and Graph Statistics is enabled, the Show Legend checkbox shows all other items that can be included on the plot. Click an item to include it.

## 5.6.3 Video Port Status

Click the *Video Port Status* icon to display settings related to the physical video ports, signal encoding and transmitted data.

**Table 5.14 Video Port Status Descriptions**

Parameter		Description
<b>Port</b>		Displays the port sink interface status for each video port.
	Connected	Displays if the device is connected to the video port.
	Powered	Displays if the connected device has power.
	Hot-Plug Asserted	Displays if the transmitter is asserting hot-plugging to the device to indicate the presence of a display to the host computer.
	Link Rate	Displays the data rate speed negotiated with the host computer on the video port.
	Timing Mode	Displays the video signal timing details detected by the transmitter from the computer connected to the video port.
	Timing Period	Displays the video signal frame period in uSecs.
	Pixel Clock	Displays the video pixel clock for the video signal on the port.
	Horizontal Resolution	Displays the horizontal resolution on the port.
	Horizontal Sync Start & End	Reserved for future use.
	Horizontal Frame Length	Displays the horizontal frame length on the port.
	Vertical Resolution	Displays the vertical resolution on the port.
	Vertical Sync Start & End	Reserved for future use.
	Vertical Frame Length	Displays the vertical frame length on the port.
	Timing Flags	Displays the timing method (progressive or interlaced) on the port.
<b>Encoding</b>		Displays the video processor for each video port.
Encoding options available on a transmitter		
	Enabled	Displays if the video processor is running.
	High Res Single Head Mode	Reserved for future use.
	Pixel Buffer Full	If enabled, a fault has occurred in the processing.
	Segments per line ... to Segment Compare Enabled	Video processor encoding setup status for diagnostic purposes only.
	Maximum Segment Compare Level	Equivalent to the Magic Eye setting on the HMX Advanced Manager server. 0 = off, 1 = Magic Eye On.
	Segment Refresh Enabled	Equivalent to Background Refresh on the HMX Advanced Manager server. Background refresh enabled (32, 64, etc.) then Segment Refresh Enabled = On.
	Segment Refresh Period	When set to a value, is equivalent to the Background Refresh on the HMX Advanced Manager server.
Encoding options available on a receiver		
	Image Hidden	Displays if the video image is hidden. If an image from a transmitter has not yet been received, it will be hidden.

**Table 5.14 Video Port Status Descriptions (continued)**

Parameter		Description
	Overlay Enabled	Displays if a GFX UI output is supported on the receiver's video port.
	OSD Enabled	Displays if UI and notification banners are active on the receiver's video port.
	Mirroring Enabled	Displays if the video processor is mirroring the video image of the other video processor
	High Res Single Head Mode	Reserved for future use
	Width	Displays the horizontal resolution of the video image decode in the video processor.
	Height	Displays the vertical resolution of the video image decode in the video processor.
	Period	Displays the frame period, in uSecs, of the video image decode in the video processor.
	Segments per line ... onwards	Displays, for diagnostic purposes only, the video processor decoding status.
<b>Transmission (For Transmitters only)</b>		Displays various settings related to the data transmission used by each video port, such as network teaming, whether the data has stopped, whether interfaces are enabled and the source and destination for each video stream.
<b>Reception (For Receivers only)</b>		Displays various settings relating to the data received on each video port, such as whether data has stopped, whether video processing is locked to the received video packets, whether interfaces are enabled and the source and destination address for each video stream.
	Teaming	Displays if network interface teaming is possible on the video port.
	Stopped	Displays if the video processor decoding is stopped.
	Locked	Reserved for future use.
	Lock Mode	
	Frame Store Filter Enabled	For support use only.
	Frame Store Number	
	Stream 1 and/or 2	Displays which network interfaces enabled and what network addresses are being used as the source of video data for the video processor of the video port.

## 5.6.4 Video Port Statistics

Click the *Video Port Statistics* icon to view and configure frame and packet counts for both video ports.

**Table 5.15 Transmitter Video Port Statistics Descriptions**

parameter	description
Dropped Frames	Displays the number of frames dropped before transmission on each video port.
Transmission Packets	Displays the total number of packets out put from the video processor on each video port.
Packets Transmitted	Displays the breakdown of packets transmitted for each video stream on each video port.

**Table 5.16 Receiver Video Port Statistics Descriptions**

parameter	description
Frame Period	Displays the latest period measurement between the last two received frames, the inverse of the video frame rate.
Packets Received	Displays the total number of packets received on the video port.
Expected Packets	Displays the total number of packets expected to be received on the video port.
Stream Packets Received	Displays the breakdown of packets received on each interface for each video port for each video stream.

## 5.7 System

Click System to view and configure various internal software options for the unit.

**NOTE:** The highlighted software version is the version currently running.

The information in the following table is applicable for both transmitters and receivers.

**Table 5.17 System Descriptions**

Parameter	Description
Preferred Software Version	The software version the unit will use when it reboots.
Recovery Software Version	The software version the unit will boot into if placed into recovery mode.
Alternate Software Version	The backup version of the software that is available.
Reboot Device	Click <i>Reboot</i> to reboot the unit.
Restore Default Settings	Click <i>Restore</i> to restore the unit back to its factory default settings.

## 5.8 Fiber Modules and Cables

Fiber modules that support various fiber optic cables are available for the HMX 8000. See the following table for specifications.



**Table 5.18 Fiber Module Specifications**

Fiber type	fiber size	fiber type	coding		distance at 10Gbps	part number
			normal applications	suggested print nomenclature		
OM1	62.5/125	Multimode (TIA-492AAAA)	Orange	62.5/125	2-26m	HMX-MM-10H-SFP
OM2	50/125	Multimode (TIA-492AAAB)	Orange	50/125	2-26m	HMX-MM-10H-SFP
OM3	50/125	Multimode 850 nm Laser-optimized) (TIA-492AAAC)	Aqua	850 LO 50/125	2-82m	HMX-MM-10H-SFP
OM4	50/125	Multimode (850 nm Laser-optimized) (TIA-492AAAC)	Aqua	850 LO 50 /125	2-300m	HMX-MM-10H-SFP
OS1 and OS2	9/125	Single-mode (TIA-492C000 / TIA-492E000)	Yellow	SM/NZDS, SM	10Km	HMX-SM-10G-SFP

This page intentionally left blank

# Appendices

## Appendix A: Technical Specifications

**Table A.1 Avocent® HMX 5100 DVI-D Transmitter Technical Specifications**

Category	Value
<b>Mechanical</b>	
Dimensions (D x W x H)	6 inches x 7.92 inches x 1.76 inches
Weight (without cables)	2.4 pounds
<b>Ports/Connectors</b>	
Teaming port	1 x SFP (fiber channel SFP module or active copper SFP module)
System port	1 x RJ-45 (1 x 8-pin modular for a direct connect configuration)
USB	1 x USB 2.0 type B
AUX (serial) port	1 x RS-232 9-pin type D
Video port	1 x DVI-D
Audio ports	2 x 3.5 mm audio jack
Direct connect	1 x 8-pin modular
Maximum resolution	1920 x 1200 at 60 Hz and 1080p
Maximum pixel rate	165 MHz
Supported video modes	All VESA and CEA video modes
<b>Power Supply</b>	
Connector	1 x IEC
AC input range	100-240 VAC
AC frequency	50/60 Hz
AC input current rating	0.8A
<b>Operating Temperature</b>	
Temperature	0-40° Celsius (32-104° Fahrenheit)

**Table A.2 Avocent® HMX 5100 DVI-D Receiver Technical Specifications**

Category	Value
<b>Mechanical</b>	
Dimensions (W x D x H)	6 inches x 7.92 inches x 1.76 inches
Weight (without cables)	2.4 pounds
<b>Ports/Connectors</b>	
Teaming port	1 x SFP (Fiber channel SFP module or active copper SFP module)
System port	1 x RJ45 (1 x 8-pin modular for a direct connect configuration)
USB	4 x USB 2.0 type A
AUX (serial) port	1 x RS232, 9-pin type D
Video port	1 x DVI-D
Audio ports	2 x 3.5 mm audio jack
Maximum resolution	1920 x 1200 at 60 Hz
Maximum pixel rate	165 MHz
Supported video modes	All VESA and CEA video modes
<b>Power Supply</b>	
Connector	1 x IEC
AC input range	100-240 VAC
AC frequency	50/60 Hz
AC Input current rating	0.8A
<b>Operating Temperature</b>	
Temperature	0°-40° Celsius (32°-104° Fahrenheit)

**Table A.3 Avocent® HMX 5200 DVI-D Transmitter Technical Specifications**

Category	Value
<b>Mechanical</b>	
Dimensions (W x D x H)	6 inches x 7.92 inches x 1.76 inches
Weight (without cables)	2.4 pounds
<b>Ports/Connectors</b>	
Teaming Port	1 x SFP (Fiber Channel SFP module or Active Copper SFP module)
System Port	1 x RJ45 (1 x 8-pin modular for a direct connect configuration)
Management Port	1 x RJ45
USB	1 x USB 2.0 type B
AUX (Serial) Port	1 x RS232, 9-pin, type D
Video Port	2 x DVI-D
Audio Ports	2 x 3.5 mm audio jack
Direct Connect	1 x 8-pin modular
Maximum Single Resolution	1920 x 1200 at 60 Hz (supports two single-link displays)
Maximum Dual Resolution	1920 x 1200 at 60 Hz (supports one dual-link display)
Maximum Single Pixel Rate	165 MHz
Maximum Dual Pixel Rate	330 MHz
Supported Video Modes	All VESA and CEA video modes
<b>Power Supply</b>	
Connector	1 x IEC
AC Input Range	100-240 VAC
AC Frequency	50/60 Hz
AC Input Current Rating	0.8A
<b>Operating Temperature</b>	
Temperature	0°-40° Celsius (32°-104° Fahrenheit)

**Table A.4 Avocent® HMX 5200 DVI-D Receiver Technical Specifications**

Category	Value
<b>Mechanical</b>	
Dimensions (W x D x H)	6 inches x 7.92 inches x 1.76 inches
Weight (without cables)	2.4 pounds
<b>Ports/Connectors</b>	
Teaming port	1 x SFP (fiber channel SFP module or active copper SFP module)
System port	1 x RJ45 (1 x 8-pin modular for a direct connect configuration)
Management port	1 x RJ45
USB	4 x USB 2.0 type A
AUX (serial) port	1 x RS232, 9-pin, type D
Video port	2 x DVI-D
Audio ports	2 x 3.5 mm audio jack
Maximum single resolution	1920 x 1200 at 60 Hz (supports two single-link displays)
Maximum dual resolution	2560 x 1600 at 60 Hz (supports one dual-link display)
Maximum single pixel rate	165 MHz
Maximum dual pixel rate	330 MHz
Supported video modes	All VESA and CEA video modes
<b>Power Supply</b>	
Connector	1 x IEC
AC Input Range	100-240 VAC
AC Frequency	50/60 Hz
AC Input Current Rating	0.8A
<b>Operating Temperature</b>	
Temperature	0°-40° Celsius (32°-104° Fahrenheit)

**Table A.5 Avocent® HMX 6200 DVI-D Transmitter Technical Specifications**

Category	Value
<b>Mechanical</b>	
Dimensions (W x D x H)	6 inches x 7.92 inches x 1.76 inches
Weight (without cables)	2.4 pounds
<b>Ports/Connectors</b>	
Teaming port	1 x SFP (fiber channel SFP module or active copper SFP module)
System port	1 x RJ45 (1 x 8-pin modular for a direct connect configuration)
Management port	1 x RJ45
USB	1 x USB 2.0 type B
AUX (serial) port	1 x RS232, 9-pin, type D
Video port	2 x DVI-D
Audio ports	2 x 3.5 mm audio jack
Maximum single resolution	1920 x 1200 at 60 Hz (supports two single-link displays)
Maximum dual resolution	2560 x 1600 at 60 Hz (supports one dual-link display)
Maximum single pixel rate	165 MHz
Maximum dual pixel rate	330 MHz
Supported video modes	All VESA and CEA video modes
<b>Power Supply</b>	
Connector	1 x IEC
AC Input range	100-240 VAC
AC frequency	50/60 Hz
AC input current rating	0.8A
<b>Operating Temperature</b>	
Temperature	0°-40° Celsius (32°-104° Fahrenheit)

**Table A.6 Avocent® HMX 6200 DVI-D Receiver Technical Specifications**

Category	Value
<b>Mechanical</b>	
Dimensions (D x W x H)	6 inches x 7.92 inches x 1.76 inches
Weight (without cables)	2.4 pounds
<b>Ports/Connectors</b>	
Teaming port	1 x SFP (fiber channel SFP module or active copper SFP module)
System port	1 x RJ45 (1 x 8-pin modular for a direct connect configuration)
Management port	1 x RJ45
USB	4 x USB 2.0 type A
AUX (serial) port	1 x RS232, 9-pin, type D
Video port	2 x DVI-D
Audio ports	2 x 3.5 mm audio jack
Maximum single resolution	1920 x 1200 at 60 Hz (supports two single-link displays)
Maximum dual resolution	2560 x 1600 at 60 Hz (supports one dual-link display)
Maximum single pixel rate	165 MHz
Maximum dual pixel rate	330 MHz
Supported video modes	All VESA and CEA video modes
<b>Power Supply</b>	
Connector	1 x IEC
AC input range	100-240 VAC
AC frequency	50/60 Hz
AC input current rating	0.8A
<b>Operating Temperature</b>	
Temperature	0°-40° Celsius (32°-104° Fahrenheit)



**Table A.7 Avocent® HMX 6200 DP Transmitter Technical Specifications**

Category	Value
<b>Mechanical</b>	
Dimensions (D x W x H)	5.3 x 5.9 x 1.5 inches
Weight (without cables)	1.7 pounds
<b>Ports/Connectors</b>	
Ethernet ports	2 x SFP (fiber channel SFP module or active copper SFP module up to 1Gb)
USB ports	1 x USB 2.0 type B
Video ports	2 x DisplayPort
Audio port	1 x 3.5mm analog audio jack
Maximum single resolution	2560x1600@60Hz
Maximum dual resolution	1920x1200 @60Hz
<b>Power Supply</b>	
Connector	3-pin proprietary connector
DC power input	12VDC, 1.5A max
AC input range	100-240VAC, 50/60Hz
Typical power consumption	7W
<b>Operating Temperature</b>	
Temperature	0°-40° Celsius (32°-104° Fahrenheit)

**Table A.8 Avocent® HMX 6200 DP Receiver Technical Specifications**

Category	Value
<b>Mechanical</b>	
Dimensions (D x W x H)	7.3 x 5.9 x 1.5 inches
Weight (without cables)	2.4 pounds
<b>Ports/Connectors</b>	
Ethernet ports	2 x SFP (fiber channel SFP module or active copper SFP module up to 1Gb)
USB ports	4 x USB 2.0 type B (2 on front and 2 on rear)
AUX (serial) port	1 x USB 2.0 type A (for use with USB-to-serial adapters)
Video port	2 x DisplayPort++ (supports HDMI with passive HDMI-to-DP cable)
Audio port	1 x 3.5mm combined headphone/mic/headset audio jack
Maximum Single Resolution	2560x1600@60Hz
Maximum Dual Resolution	1920x1200 @60Hz
<b>Power Supply</b>	
Connector	3-pin proprietary connector
DC power input	12VDC, 1.5A max
AC input range	100-240VAC, 50/60Hz
Typical power consumption	7W
<b>Operating Temperature</b>	
Temperature	0°-40° Celsius (32°-104° Fahrenheit)

**Table A.9 Avocent® HMX 5150T DVI-D, 5150T DP, 6150T DVI-D and 6150T DP Transmitter Technical Specifications**

Category	Value
<b>Mechanical</b>	
Dimensions (W x D x H)	2.17 in x 1 in x 4.3 in (55 mm x 25 mm x 110 mm)
Weight	0.4 lbs (0.2 kgs)
<b>Ports/Connectors</b>	
USB	2 x USB 2.0 type A (HMX 5150T transmitter is HID-only; HMX 6150T transmitter supports transparent high-speed USB)
Video Port	1 x DVI-D or 1 x DisplayPort
Audio Ports	2 x 3.5 mm audio jack (HMX 6150T transmitter also supports digital audio via HDMI and DisplayPort)
Maximum Resolution	HMX 5150T transmitter: 1920 x 1200 at 60 Hz (supports two single-link displays) HMX 6150T transmitter: 2560 x 1600 @ 60 Hz
<b>Power Supply</b>	
Connector	USB power: 2 x USB2.0; External power: 5VDC, 1A
<b>Operating Temperature</b>	
Temperature	32°-104° Fahrenheit (0°- 40° Celsius)

**Table A.10 Avocent® HMX 6210 DVI-D Transmitter Technical Specifications**

category	value
<b>Mechanical</b>	
Dimensions (W x D x H)	6 inches x 7.92 inches x 1.76 inches
Weight (without cables)	2.4 pounds
<b>Ports/Connectors</b>	
Teaming port	1 x SFP (fiber channel SFP module or active copper SFP module)
System port	1 x RJ45 (1 x 8-pin modular for a direct connect configuration)
VNC port	1 x RJ45
USB	1 x USB 2.0 type B
AUX (serial) port	1 x RS232, 9-pin, type D, signal extension up to a baud rate of 115200, software flow control, no hardware flow control
Video port	2 x DVI-D
Audio ports	2 x 3.5 mm audio jack
Maximum single resolution	1920 x 1200 at 60 Hz (supports two single-link displays)
Maximum dual resolution	2560 x 1600 at 60 Hz (supports one dual-link display)
Maximum single pixel rate	165 MHz
Maximum dual pixel rate	330 MHz
Supported video modes	All VESA and CEA video modes
<b>Power Supply</b>	
Connector	1 x IEC
AC input range	100-240 VAC
AC frequency	50/60 Hz
AC input current rating	0.8A
<b>Operating Temperature</b>	
Temperature	32°-104° Fahrenheit (0°- 40° Celsius)

**Table A.11 Avocent® HMX 6500 Technical Specifications**

<b>category</b>	<b>value</b>
<b>Mechanical</b>	
Dimensions (W x D x H)	8.3 inches by 8.5 inches by 1.6 inches
Weight (without cables)	4 pounds
<b>Ports/Connectors</b>	
Teaming port	2 x SFP (fiber channel SFP module or active copper SFP module)
System port	1 x RJ45 (1 x 8-pin modular for a direct connect configuration)
USB	6 USB 2.0 Type B ports with True Emulation to support keyboard, mouse and touch.
Video port	2 x DisplayPort
Audio ports	Analog line in/out 2 channel, 16 bit, 48KHz, 1V RMS in, 1V RMS out
Maximum single resolution	2560x1600 with refresh rates up to 60 Hz
Maximum dual resolution	1920x1200 with refresh rates up to 60 Hz.
Supported video modes	
<b>Power Supply</b>	
Connector	3-pin proprietary connector
DC power	12VDC, 5A max
AC input range	100-240VAC, 50/60Hz
Power consumption	20W (typical)
<b>Operating Temperature</b>	
Temperature	32°-104° Fahrenheit (0°- 40° Celsius)

**Table A.12 Avocent® HMX 8000 Transmitter Technical Specifications**

category	value
<b>Mechanical</b>	
Dimensions (W x D x H)	8.3 inches by 8.5 inches by 1.6 inches
Weight (without cables)	4 pounds
<b>Ports/Connectors</b>	
Teaming port	1 x SFP (fiber channel SFP module or active copper SFP module)
System port	1 x RJ45 (1 x 8-pin modular for a direct connect configuration)
USB	4 USB 2.0 Type B ports with true emulation to support keyboard, mouse and touch.
Video port	2 x DisplayPort
Audio ports	Analog line in/out 2 channel, 16 bit, 48KHz, 1V RMS in, 1V RMS out
Maximum single resolution	4K UHD 3840x2160 or DCI 4096x2160, with refresh rates up to 60 Hz.
Maximum dual resolution	4K UHD 3840x2160 or DCI 4096x2160, with refresh rates up to 60 Hz.
Supported video modes	4K UHD or DCI with refresh rates of 60Hz
<b>Power Supply</b>	
Connector	3-pin proprietary connector
AC input range	100-240VAC, 50/60Hz
AC input current rating	5A
<b>Operating Temperature</b>	
Temperature	32°-104° Fahrenheit (0°- 40° Celsius)

**Table A.13 Avocent® HMX 8000 Receiver Technical Specifications**

category	value
<b>Mechanical</b>	
Dimensions (W x D x H)	8.3 inches by 8.5 inches by 1.6 inches
Weight (without cables)	4 pounds
<b>Ports/Connectors</b>	
Teaming port	1 x SFP (fiber channel SFP module or active copper SFP module)
System port	1 x RJ45 (1 x 8-pin modular for a direct connect configuration)
USB	4 USB 2.0 Type B ports with true emulation to support keyboard, mouse and touch.
Video port	2 x DisplayPort
Audio ports	Analog line in/out 2 channel, 16 bit, 48KHz, 1V RMS in, 1V RMS out
Maximum single resolution	4K UHD 3840x2160 or DCI 4096x2160, with refresh rates up to 60 Hz.
Maximum dual resolution	4K UHD 3840x2160 or DCI 4096x2160, with refresh rates up to 60 Hz.
Supported video modes	4K UHD or DCI with refresh rates of 60Hz
<b>Power Supply</b>	
Connector	3-pin proprietary connector
AC Input range	100-240VAC, 50/60Hz
AC Input current rating	5A
<b>Operating Temperature</b>	
Temperature	32°-104° Fahrenheit (0°- 40° Celsius)

## Appendix B: Pinout Information

### B.1 Connecting device consoles or modems to serial ports

RS-232, 9-pin, type D adaptors can be used to connect remote computers or modems to HMX extender serial ports. The following pinout configurations are supported.

**Table B.1 Pinout Configuration**

Pin Number	Signal Name	Input/Output
1	Data Carrier Detect (DCD)	IN
2	Receiver Data (RxD)	IN
3	Transmit Data (TxD)	OUT
4	Data Terminal Ready (DTR)	OUT
5	Ground (GND)	N/A
6	Data Set Ready (DSR)	IN
7	Request to Send (RTS)	OUT
8	Clear to Send (CTS)	IN

















## Appendix C: On-Screen Display

In addition to the System Configuration utility user interface, the HMX extender system incorporates an On-Screen Display (OSD) interface, allowing you to access the transmitter from the local keyboard and mouse. The OSD is displayed on a monitor connected to a receiver and has a list of available targets to which you can connect. The OSD also supports user defined hotkeys and favorites for frequently used actions.

The OSD is positioned in the center of the screen and can be one of two sizes depending on current receiver resolution. The resolution used is the preferred resolution of the monitor as identified by the monitor EDID. If there is no video connection to a target, the OSD uses the display resolution on the receiver.

**Table C.1 Icon Descriptions**

Icon	Description
Favorites	
	Currently showing all channels/presets.
	Currently showing only favorites.
	Currently showing only numbered shortcuts.
	Click to add this channel as a favorite.
	This channel is a numbered shortcut.
Sorting	
	Currently showing channels and presets. Click to change.
	Currently showing only channels. Click to change.
	Currently showing only presets. Click to change.
	Filter this column using the specified term.
	Remove the search filter.
	Click to sort the list in ascending order via this column.
	The list is sorted in ascending order via this column.
Top Corner	
	Enter Remote OSD mode.
	Exit Remote OSD mode.

**Table C.1 Icon Descriptions (continued)**

















Icon	Description
	Display the help pages.
	Exit from the help pages.
	Refresh the current page.
	Close the OSD.
<b>Connection Buttons</b>	
 View Mode  Shared mode  Exclusive mode	Click to connect to the channel/preset.
 View mode  Shared mode  Exclusive mode	You are currently connected to the channel/preset.
 View mode  Shared mode  Exclusive mode	Another user is connected to the channel/preset.

Table C.1 Icon Descriptions (continued)

Icon	Description
 View mode	You are unable to connect to the channel/preset.
 Shared mode	
 Exclusive mode	
Blank icons	Connection mode is not permitted by the administrator (for example, a channel does not allow exclusive connections and a user does not have exclusive rights.)
	End this connection.

**To access the OSD:**

1. From a receiver, press **Ctrl +Alt +C** to access the OSD. The default hotkey can be configured at the system level and for each user.
2. When the OSD launches, enter your receiver username and password.
3. Click *Login*.

**C.1 Setting OSD alerts**

Alerts can be set within the receiver System Configuration utility to ensure that notifications are generated when changes are made in the OSD.

**To set OSD alerts:**

1. From the receiver System Configuration utility, select *System Configuration* on the left side of the page.
2. Select the Enable OSD alerts checkbox.

**C.2 Using a remote OSD**

The remote OSD feature allows authorized users to access and take control of remote receivers if necessary.

**NOTE: The remote OSD has a yellow background to distinguish it from the standard local OSD.**

**To use the remote OSD feature:**

1. Log in to the OSD and select a remote receiver from the list.

**NOTE: You cannot log out or log in while in a remote OSD.**

2. After using the displayed remote OSD, click X to exit.

**C.3 Hotkeys**

The OSD supports user-defined hotkeys and favorites for frequently used actions. These default hotkey combinations can be altered within the HMX Advanced Manager software.

**Table C.2 Key Combination Description**

Key Combination	Description
Left Ctrl + Left Alt + C	Launch the OSD.
Left Ctrl + Left Alt + X	Disconnect the current receiver.
Left Ctrl + Left Alt + 3	Connect to the channel/preset saved in shortcut slot 3.
Left Ctrl + Left Alt + A	Re-connect to the last channel.
Left Ctrl + Left Alt + V	Change the current connection to the view-only mode.
Left Ctrl + Left Alt + S	Change the current connection to the shared mode.
Left Ctrl + Left Alt + E	Change the current connection to the exclusive mode.

## C.4 Favorites and shortcuts

When the OSD contains many possible channels and presets, you can mark the most commonly visited ones as favorites. For those channels that you access by keyboard shortcut, there are also ten assignable hotkeys.

### To create a new favorite:

1. Log in to the OSD.
2. Click the favorites icon next to the channel or preset you choose.
3. Click *Save*.

### To create a new hotkey:

1. Log in to the OSD.
2. Click the favorites icon next to the channel or preset.
3. Click the 1 or 0 number prefix from an available slot.
4. Click *View Only*, *Shared* or *Exclusive*.
5. Click *Save*.

### To remove a hotkey:

1. Click the favorites icon.
2. Click the number prefix from 1 to 0 of an available slot.
3. To remove a previous channel from a slot, click the *X* icon on the right side of the slot.

## Appendix D: Supported Video Modes

The following video modes are supported and can be automatically configured by the transmitter. If a recognized video mode cannot be found, contact Technical Support for help.

**Table D.1 Supported Video Modes**

cvt reduced 640 x 480 @ 60Hz	cvt reduced 1280 x 1024 @ 60Hz
vesa 640 x 480 @ 60Hz	vesa 1280 x 1024 @ 60Hz
vesa 640 x 480 @ 72Hz	ibm 1280 x 1024 @ 67Hz
vesa 640 x 480 @ 75Hz	vesa 1280 x 1024 @ 75Hz
ibm 640 x 480 @ 75Hz	cvt reduced 1360 x 768 @ 60Hz
cvt reduced 800 x 600 @ 60Hz	vesa 1360 x 768 @ 60Hz
vesa 800 x 600 @ 56Hz	vesa 1366 x 768 @ 60Hz
vesa 800 x 600 @ 60Hz	vesa reduced 1366 x 768 @ 60Hz
vesa 800 x 600 @ 72Hz	vesa 1400 x 1050 @ 60Hz
vesa 800 x 600 @ 75Hz	vesa reduced 1400 x 1050 @ 60Hz
cvt 1024 x 600 @ 60Hz	cvt reduced 1600 x 900 @ 60Hz
cvt reduced 1024 x 600 @ 60Hz	vesa reduced 1600 x 900 @ 60Hz
cvt reduced 1024 x 768 @ 60Hz	cvt reduced 1600 x 1200 @ 60Hz
vesa 1024 x 768 @ 60Hz	vesa 1600 x 1200 @ 60Hz
vesa 1024 x 768 @ 70Hz	vesa 1680 x 1050 @ 60Hz
ibm 1024 x 768 @ 70Hz	vesa reduced 1680 x 1050 @ 60Hz
vesa 1024 x 768 @ 75Hz	cvt reduced 1920 x 1080 @ 50Hz
ibm 1024 x 768 @ 75Hz	cvt 1920 x 1080 @ 50Hz
cvt reduced 1152 x 864 @ 60Hz	vesa 1920 x 1080 @ 60Hz
vesa 1152 x 864 @ 70Hz	vesa reduced 1920 x 1200 @ 60Hz
vesa 1152 x 864 @ 75Hz	sun 1024 x 768 @ 77Hz
cvt 1280 x 720 @ 60Hz	sun 1152 x 900 @ 66Hz
vesa 1280 x 720 @ 60Hz	sun 1152 x 900 @ 76Hz
vesa 1280 x 768 @ 60Hz	sun 1024 x 1024 @ 61Hz
vesa reduced 1280 x 786 @ 60Hz	sun 1280 x 1024 @ 67Hz
vesa 1280 x 786 @ 75Hz	sun 1280 x 1024 @ 76Hz
vesa 1280 x 786 @ 85Hz	4K UHD 3840x2160 or DCI 4096x2160, with refresh rates up to 60 Hz.
vesa 1280 x 800 @ 60Hz	
cvt reduced 1280 x 960 @ 60Hz	
vesa 1280 x 960 @ 60Hz	

## Appendix E: Troubleshooting

### E.1 Video image of the HMX receiver has horizontal lines across the screen

When video is transmitted by extenders, the various lines of each screen are divided up and transmitted as separate data packets. If the reception of those packets is disturbed, blinding occurs, which means lines are displayed in place of the missing video data packets.

Possible causes for the loss of data packets:

- Incorrect switch configuration. The problem could be caused by multicast flooding, which causes unnecessary network traffic. IGMP snooping is designed to combat this, however, there can be numerous causes of the flooding.
- Speed/memory bandwidth issues within one or more switches. The speed and capabilities of different switch models varies greatly. If a switch cannot maintain pace with the quantity of data being sent through it, it inevitably starts dropping packets.
- One or more HMX units may output jumbo frames due to the video resolution (2048 horizontal pixels) being used. If jumbo frames are output by an HMX unit, but the network switches are configured to use jumbo frames, the switches attempt to break the large packets into standard packets. This process introduces a certain latency and could cause dropped packets.

#### Solutions for the loss of data packets:

- Ensure that IGMP snooping is enabled on all switches within the subnet.
- Where each HMX unit is connected as the sole device on a port connection to a switch, enable IGMP Fast-Leave (also called Immediate Leave) to reduce unnecessary processing on each switch.
- Check the video resolutions provided to the HMX transmitters. If resolutions using 2048 horizontal pixels are unavoidable, ensure the Jumbo frames are enabled on all switches.
- Check the forwarding mode on the switches. If "Store and forward" is being used, try selecting *Cut-through* to reduce latency on lesser switch designs.
- Ensure that one device within the subnet is correctly configured as an IGMP Querier. This is usually a layer three switch or multicast router.
- Try adjusting the transmitter settings on each HMX to make the output data stream as efficient as possible.

### E.2 Mouse pointer of the receiver is slow

A slow mouse pointer is often related to either using dithering on the video output of one or more transmitting computers or using VGA-to-DVI video converters.

Dithering is used to improve the perceived quality and color depth of images by diffusing or altering the color of pixels between video frames. This practice is commonly used on Apple Mac computers using ATI or Nvidia® graphics cards. VGA-to-DVI converters unwittingly produce a similar issue by creating high levels of pixel background noise.

HMX units attempt to considerably reduce network traffic by transmitting only the pixels that change between successive video frames. When dithering is enabled and/or VGA-to-DVI converters are used, this can have the effect of changing almost every pixel between each frame, thus forcing the HMX transmitter to send each entire frame, resulting in greatly increased network traffic and sluggish performance.

#### Solutions for a slow mouse pointer:

- For Linux®, check the video settings on the computer. If the dither video box option is enabled, disable it.

- Apple Macintosh with NVIDIA graphics uses the Vertiv utility for Mac – contact Technical Support.

#### **Apple Mac with ATI graphics:**

- Enable the anti-dither removal feature.

#### **Windows PCs:**

- If you suspect these issues with computers, contact Technical Support for assistance.

Replace old VGA adaptors on host computers with DVI video cards.

### **E.3 Monitor displays pink screen**

It is possible that the source computer and HMX transmitter are sending a high resolution dual-link signal in response to a request from your dual-link monitor. However, your HMX receiver is unable to correctly process the signal, causing the pink screen issue (DVI resolutions above 1920 x 1200 are generally dual-link).

HMX 6200T and 6210T transmitters are able to send dual-link video when requested, however, an HMX 6200R receiver is required to process the higher resolution signal fully at the other end. Other receivers, such as the HMX1000R, 5100R and 5200R, cannot process dual-link DVI because they are single-link devices.

#### **Solutions for a pink screen:**

Ensure that the HMX transmitter is set to supply a single-link EDID to the graphics card. When the video source is changed to a single-link video resolution, the pink screen should disappear and the video should be displayed normally. Alternatively, change the monitor to a single-link DVI monitor.

IMPORTANT: Do not to mix dual-link transmitters with single-link receivers.

On an HMX Advanced Manager controlled system, verify the Video compatibility checkbox is enabled to ensure the correct video mode is displayed for the monitor being used.

### **E.4 Audio output of the receiver sounds scratched**

Audio crackle, like blinding, is a symptom of missing packets.

#### **Solutions for missing packets:**

See Solutions under blinding.

### **E.5 HMX Advanced Manager cannot locate HMX extenders**

The following are possible causes:

- The HMX units must be reset to their zero config IP addresses for HMX Advanced Manager discovery. If you have a working network of HMX units without HMX Advanced Manager and then add HMX Advanced Manager to the network, the HMX Advanced Manager will not discover the HMXs until they are reset to the zero config IP addresses.
- Layer 2 Cisco® switches may have Spanning Tree Protocol (STP) enabled but not have portfast enabled on the ports to which HMX units are connected. Without portfast enabled, HMX units are assigned the same zero config IP address at reboot and HMX Advanced Manager only acquires them one at a time on a random basis.



You can tell whether portfast is enabled on a switch that is running STP. When you plug the network cable from a working HMX unit into the switch port, check how long it takes for the port indicator to change from orange to green. If it takes roughly one second, portfast is on; if it takes roughly thirty seconds, portfast is disabled.

**Solutions to locate HMX extenders:**

- Ensure the HMX units and the HMX Advanced Manager server are located in the same subnet. HMX Advanced Manager cannot cross subnet boundaries.
- Manually reset the HMX units to their zero config IP addresses.
- Enable portfast on all switch ports that have HMX units attached to them, or try temporarily disabling STP on the switches while HMX Advanced Manager attempts to locate HMX units.

This page intentionally left blank

### **Connect with Vertiv on Social Media**



<https://www.facebook.com/vertiv/>



<https://www.instagram.com/vertiv/>



<https://www.linkedin.com/company/vertiv/>



<https://www.twitter.com/Vertiv/>



---

Vertiv.com | Vertiv Headquarters, 1050 Dearborn Drive, Columbus, OH, 43085, USA

© 2022 Vertiv Group Corp. All rights reserved. Vertiv™ and the Vertiv logo are trademarks or registered trademarks of Vertiv Group Corp. All other names and logos referred to are trade names, trademarks or registered trademarks of their respective owners. While every precaution has been taken to ensure accuracy and completeness here, Vertiv Group Corp. assumes no responsibility, and disclaims all liability, for damages resulting from use of this information or for any errors or omissions. Specifications, rebates and other promotional offers are subject to change at Vertiv's sole discretion upon notice