

## SYSTEM OVERVIEW

**Description:** 120 VAC @ up to 24 kVA Inverter System

The Vertiv™ NetSure™ Inverter System is a complete inverter system containing inverters, intelligent control, metering, monitoring, and distribution.

The inverter system can be set to operate in one of three input power modes: AC Input Power Mode, DC Input Power Mode, and DC Input Only Power Mode.

**Note:** *List 05 and 05E have no AC input and can only operate in 'DC Input Only Power Mode'.*

- In the AC Input Power Mode, each inverter module operates with the commercial AC input to supply 120 VAC power to the loads. In the event commercial AC power fails or becomes abnormal, the inverter modules immediately transfer operation with the 48 VDC nominal input to power to the inverters.
- In the DC Input Power Mode, each inverter module operates with the 48 VDC nominal input to supply 120 VAC power to the loads. In the event DC power fails or becomes abnormal or an inverter module fails, the inverter module immediately transfers operation with the commercial 120 VAC input to power to the inverters.
- In the DC Input Only Power Mode, each inverter module operates with the 48 VDC nominal input to supply 120 VAC power to the loads. In the event DC power fails or becomes abnormal or an inverter module fails, the inverter module shuts off.

The inverter system contains an EPO (Emergency Power Off) function. Connection points for a normally closed external EPO switch are provided on the customer interface board. If an external EPO switch is wired to the customer interface board, activating the switch to open the circuit activates the EPO function. The EPO function shuts down and locks out the inverters. When the EPO switch is returned to normal (closed loop), the inverters remain off. The inverters will restart when the AC and DC power inputs are removed and restored after 30 seconds or more (until the LEDs on the modules extinguish) (depending on the synchronizing time with the system). (Note that there is an EPO shorting link factory installed that can be replaced with a customer provided switch.)

This inverter system consists of the following components. These components are factory packaged to provide the inverter system configurations listed in Table 1. Note the ratings are not only determined by the maximum number of inverters the system can be provided with, but also the rating of the AC distribution panel. The overall system rating cannot exceed the AC distribution panel rating.

- **Inverter Module Mounting Shelf(s)**  
The inverter system consists of one or more inverter module mounting shelves, depending on power rating. The inverter module mounting shelves house the inverter modules.
- **Inverter Modules**  
The inverter system utilizes 1 kVA/1 kW inverter modules (1 kVA at 40 °C and 0.5 kVA at 65 °C), supplying 120 VAC power from a commercial AC power source or from a 48 VDC nominal input. Refer to the Inverter Instructions (UM11201000) for more information.
- **AC Load Distribution Shelf(s)**  
The inverter system consists of one or more AC load distribution shelves, depending on power rating. A choice of a bulk output AC load distribution shelf or a NEMA output AC load distribution shelf is provided.
- **NCU (NetSure™ Control Unit) Controller**  
The controller provides inverter control, metering functions, monitoring functions, and local/remote alarm functions. The controller also provides data acquisition and system alarm management. The controller contains a color LCD display and keypad for local access. The controller provides an Ethernet port and comes with comprehensive webpages for remote access. The controller has SNMP capability for remote system management. The controller supports software upgrade via its USB port. Refer to the NCU Controller Instructions (UM1M830BNA) for more information.

**Note:** *If the inverter system is being added to an existing Vertiv™ NetSure™ Power System with an NCU controller, a Rev B version NCU should be utilized in the DC power system.*

Vertiv™ NetSure™ Inverter System  
System Application Guide

System Configurations	List Number
19", 5 kVA maximum, Bulk Output Shelf	584130100 List 01
19", 5 kVA maximum, NEMA Output Shelf	584130100 List 07
19", 6 kVA maximum, Bulk Output Shelf	584130100 List 01E
23", 6 kVA maximum (5.76 kVA per NEC breaker de-rating), NEMA Output Shelf	584130100 List 02
23", 6 kVA maximum (5.76 kVA per NEC breaker de-rating), NEMA Output Shelf	584130100 List 02E
19", 10 kVA maximum, Bulk Output Shelf	584130100 List 03
19", 10 kVA maximum, NEMA Output Shelf	584130100 List 08
19", 12 kVA maximum, Bulk Output Shelf	584130100 List 03E
23", 12 kVA maximum (11.5 kVA per NEC breaker de-rating), NEMA Output Shelf	584130100 List 04
23", 12 kVA maximum (11.5 kVA per NEC breaker de-rating), NEMA Output Shelf	584130100 List 04E
19", 15 kVA maximum, Bulk Output Shelf - DC INPUT ONLY	584130100 List 05
19", 20 kVA maximum, Bulk Output Shelf - DC INPUT ONLY	584130100 List 05E
23", 18 kVA maximum (18 kVA per NEC breaker de-rating), NEMA Output Shelf	584130100 List 06
23", 24 kVA maximum (23 kVA per NEC breaker de-rating), NEMA Output Shelf	584130100 List 06E

Table 1

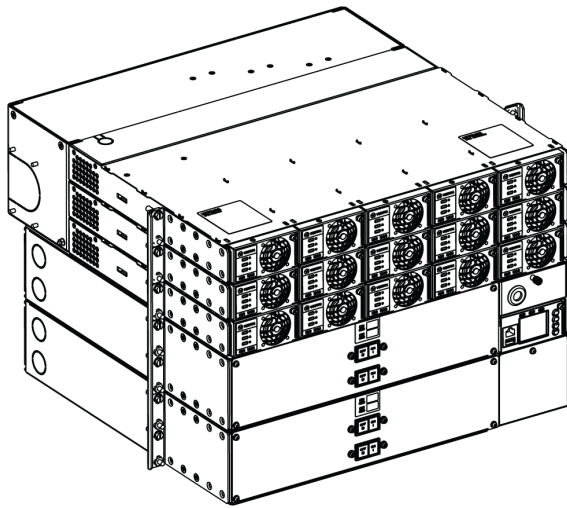

15 kVA Bulk Output System  
(584130100 List 05)

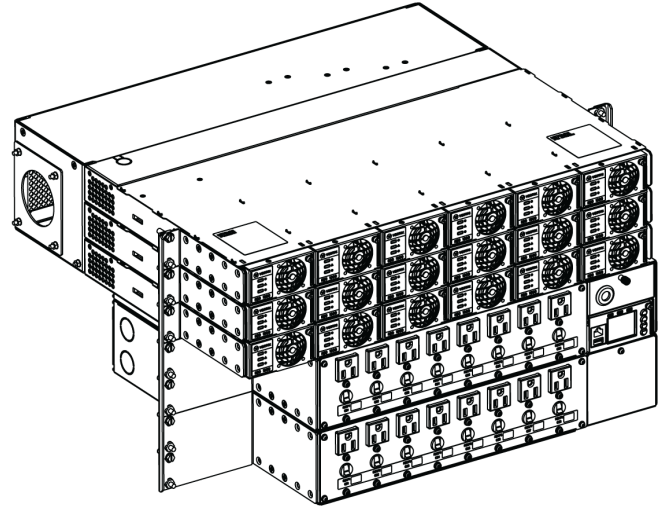

18 kVA NEMA Output System  
(584130100 List 06)

# Vertiv™ NetSure™ Inverter System

## System Application Guide

---

### **General Inverter Systems Specifications**

See detailed specifications on page 42.

Family:	NetSure™
Spec. No.:	584130100
AC Input Voltage:	Nominal 120 VAC, single phase, 50 Hz or 60 Hz. Operating range 96 VAC to 140 VAC. Acceptable frequency range 47 Hz to 53 Hz or 57 Hz to 63 Hz.
DC Input Voltage:	Nominal -48 VDC. Operating range -42 VDC to -58 VDC.
AC Output Voltage	120 VAC, 50 Hz or 60 Hz
AC Output Capacity:	See Table 1.
11201000 Inverter Rating:	See UM11201000.
Agency Approval:	cULus Listed to UL 1778
Framework Type:	For mounting in a 19-inch or 23-inch wide relay rack (depending on configuration)
Mounting Width:	19-inches or 23-inches, nominal (depending on configuration)
Mounting Depth:	Varies (see “Overall Dimensions” on page 44)
Mounting Height:	Varies (see “Overall Dimensions” on page 44)
Access:	Front and Rear for Installation and Maintenance, Front for Operation
Control:	Microprocessor
Color:	Faceplates: Textured Gray Other Surfaces: Bright Zinc
Environment:	-20 °C to +65 °C (-4 °F to +149 °F) The inverter delivers 50% load at an ambient temperature of +65 °C (+149 °F) with linear derating to 50% from 45 °C to 65 °C. The inverter delivers 0% load at an ambient temperature of +80 °C with linear derating to 0% from 65 °C to 80 °C.

**TABLE OF CONTENTS**

SYSTEM OVERVIEW .....1

MAIN COMPONENTS ILLUSTRATIONS .....6

    584130100 .....6

LIST DESCRIPTIONS .....7

    List Numbers .....7

        List 01: Inverter System, 19", up to 5 kVA maximum, Bulk Output .....7

        List 01E: Inverter System, 19", up to 6 kVA maximum, Bulk Output .....8

        List 02: Inverter System, 23", up to 6 kVA maximum (5.76 kVA per NEC Breaker De-rating), NEMA Output .....9

        List 02E: Inverter System, 23", up to 6 kVA maximum (5.76 kVA per NEC Breaker De-rating), NEMA Output .....10

        List 03: Inverter System, 19", up to 10 kVA maximum, Bulk Output .....11

        List 03E: Inverter System, 19", up to 12 kVA maximum, Bulk Output .....12

        List 04: Inverter System, 23", up to 12 kVA maximum (11.5 kVA per NEC Breaker De-rating), NEMA Output .....13

        List 04E: Inverter System, 23", up to 12 kVA maximum (11.5 kVA per NEC Breaker De-rating), NEMA Output .....14

        List 05: Inverter System, 19", up to 15 kVA maximum, Bulk Output - DC INPUT ONLY .....15

        List 05E: Inverter System, 19", up to 20 kVA maximum, Bulk Output - DC INPUT ONLY .....16

        List 06: Inverter System, 23", up to 18 kVA maximum (18 kVA per NEC Breaker De-rating), NEMA Output .....17

        List 06E: Inverter System, 23", up to 24 kVA maximum (23 kVA per NEC Breaker De-rating), NEMA Output .....18

        List 07: Inverter System, 19", up to 5 kVA maximum, NEMA Output .....19

        List 08: Inverter System, 19", up to 10 kVA maximum, NEMA Output .....20

ACCESSORY DESCRIPTIONS .....21

    Controller .....21

        NCU (NetSure™ Control Unit) Controller, P/N 1M830BNA .....21

        Optional Temperature Probes .....22

    Optional SM-Temp Temperature Concentrator .....23

        SM-Temp Temperature Concentrator, P/N 547490 .....23

        SM-Temp Jumpers, P/N 552888 .....23

    Inverter .....23

        Inverter Module, P/N 11201000 .....23

        Inverter Module Mounting Position Blank Cover Panel, P/N SXA1100035/1 .....23

    19" to 23" Relay Rack Adapter Brackets .....24

    Crimp Lugs .....24

        Standard Crimp Lug Tables .....24

    User Replaceable Components .....24

RECOMMENDED WIRE SIZES, BRANCH CIRCUIT PROTECTION, CRIMP LUGS, AND WIRING ILLUSTRATIONS .....25

    Relay Rack Frame Grounding Requirements .....25

    System Shelf Frame Grounding .....25

    AC Input Connections (Spec. No. 584130100 Lists 01, 01E, 02, 02E, 03, 03E, 04, 04E, 06, 06E, 07, and 08 - does NOT apply to Lists 05 and 05E) .....28

        AC Input Branch Circuit Protection and Wire Size Selection .....28

    DC Input Connections (Spec. No. 584130100 Lists 01, 01E, 02, 02E, 03, 03E, 04, 04E, 05, 05E, 06, 06E, 07, and 08) .....30

        DC Input Branch Circuit Protection and Wire Size Selection .....30

    AC Output Connections (Spec. No. 584130100 List 01, 01E, 03, 03E, 05, and 05E) .....34

        AC Output Branch Circuit Protection and Wire Size Selection .....34

    AC Output Connections (Spec. No. 584130100 List 02, 02E, 04, 04E, 06, 06E, 07, and 08) .....37

    External Alarm, Reference, Monitoring, and Control Connections .....38

        General .....38

        External Alarm, Reference, Monitoring, and Control Connections Locations .....38

        IB2 (Controller Interface Board) .....39

        Customer Interface Board – **MANDATORY WIRING FOR SYSTEM OPERATION!!** .....40

    NCU Controller Ethernet Connection (if required) .....41

        NCU Front Panel Ethernet Port .....41

        IB4 Board Ethernet Port .....41

SPECIFICATIONS .....42

    1. System .....42

        1.1 AC Input and DC Input Ratings (see also “General Inverter Systems Specifications” starting on page 3.) .....42

# Vertiv™ NetSure™ Inverter System

## System Application Guide

---

1.2 AC Output Ratings (see also “General Inverter Systems Specifications” starting on page 3.).....	42
1.3 Environmental Ratings.....	42
1.4 Compliance Information.....	43
1.5 IB2 (Controller Interface Board) Ratings.....	43
1.6 Safety Standard IEC/EN62040-1-1.....	43
2. Inverter.....	43
3. Controller.....	43
MECHANICAL SPECIFICATIONS.....	44
Overall Dimensions.....	44
List 01 and 07 (List 01 Shown).....	44
List 01E.....	45
List 02.....	46
List 02E.....	47
List 03 and 08 (List 03 Shown).....	48
List 03E.....	49
List 04.....	50
List 04E.....	51
List 05.....	52
List 05E.....	53
List 06.....	54
List 06E.....	55
Weights.....	56
RELATED DOCUMENTATION.....	56

**MAIN COMPONENTS ILLUSTRATIONS**

**584130100**

List 05 and List 06 Shown.  
Other Configurations Similar.

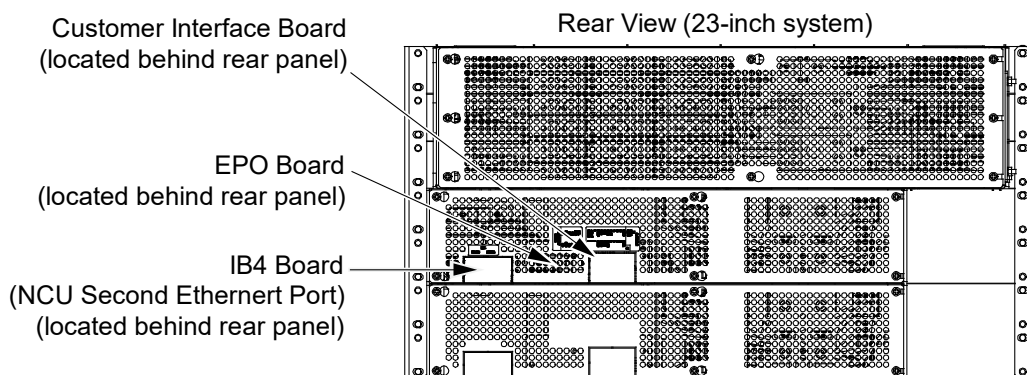
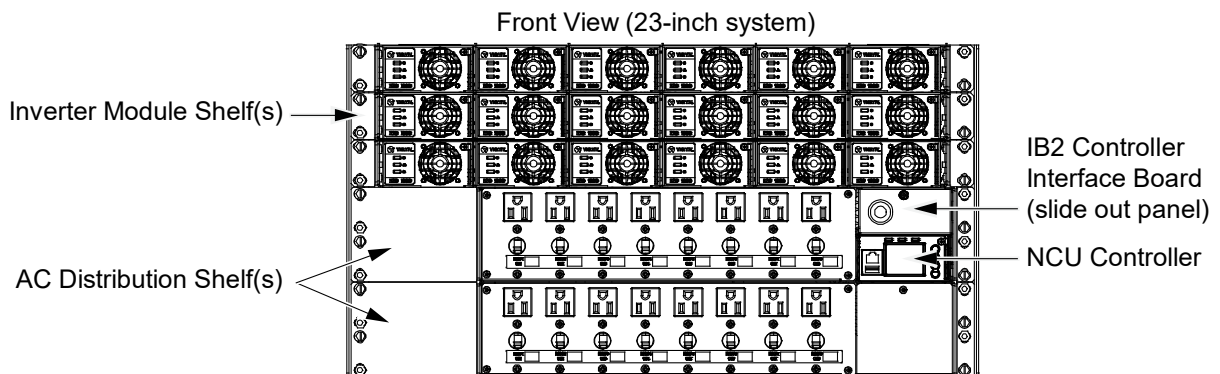
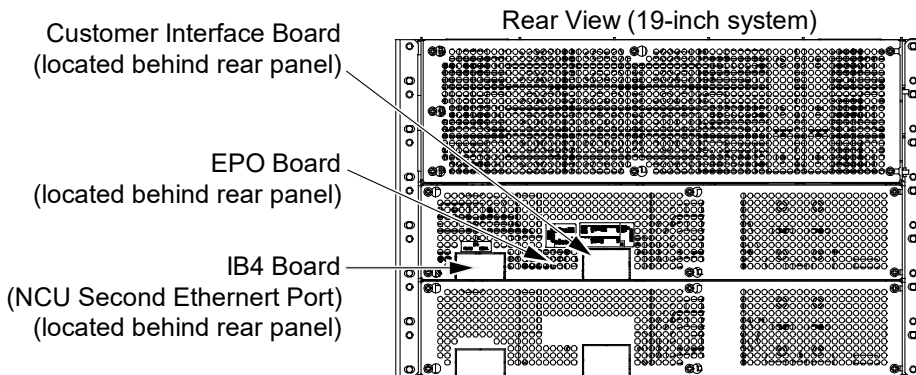
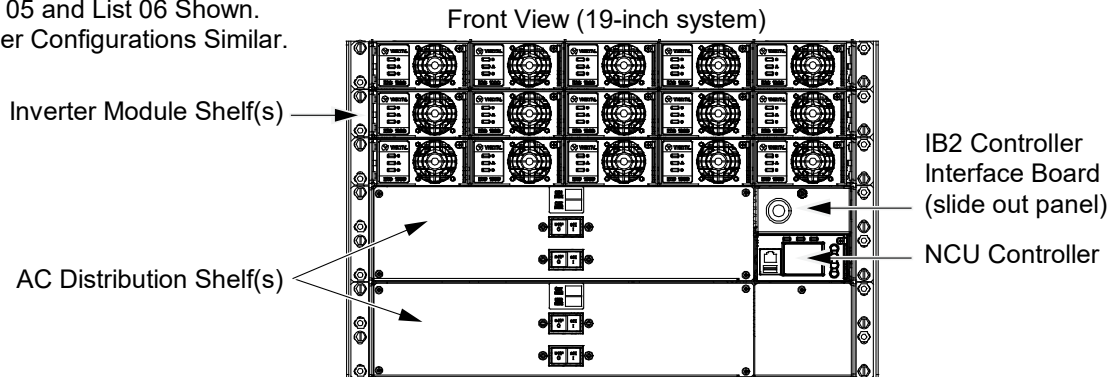

## LIST DESCRIPTIONS

### List Numbers

#### List 01: Inverter System, 19", up to 5 kVA maximum, Bulk Output

##### Features

Provides a bulk output inverter system consisting of the following factory packaged components.

- ◆ One (1) 5-position inverter module mounting shelf.
- ◆ One (1) 1U bulk output AC distribution shelf (includes one 70 A circuit breaker).
- ◆ Accepts one (1) NCU Controller.
- ◆ Includes the IB4 board (provides a network connection point for NCU remote access).
- ◆ Includes the IB2 controller interface board (provides eight (8) programmable form C- relay outputs, eight (8) programmable binary inputs, and two (2) temperature inputs).
- ◆ Includes the EPO (Emergency Power Off) board which provides the EPO function.
- ◆ Includes the customer interface board (see Figure 8).

##### Restrictions

Mounts in a 19" wide relay rack.

Maximum system output power is 5 kVA at 40 °C.

Maximum system output power is 2.5 kVA at 65 °C.

Output load not to exceed 80% (56 A) of rated value of 70 A circuit breaker at 40 °C and 65 °C.

##### Ordering Notes

- 1) Order one (1) NCU Controller P/N 1M830BNA (see page 21).  
Also specify appropriate configuration file for your site.
- 2) Order up to five (5) inverter modules P/N 1I1201000 per inverter module mounting shelf (see page 23).
- 3) Order an inverter mounting position blank cover panel P/N SXA1100035/1 for each empty inverter mounting position in the system as desired (see page 23).
- 4) Order optional temperature probes for ambient and battery temperature monitoring as required. Refer to "Optional Temperature Probes" on page 22.
- 5) Order DC input lugs as required per "Crimp Lugs" on page 24.

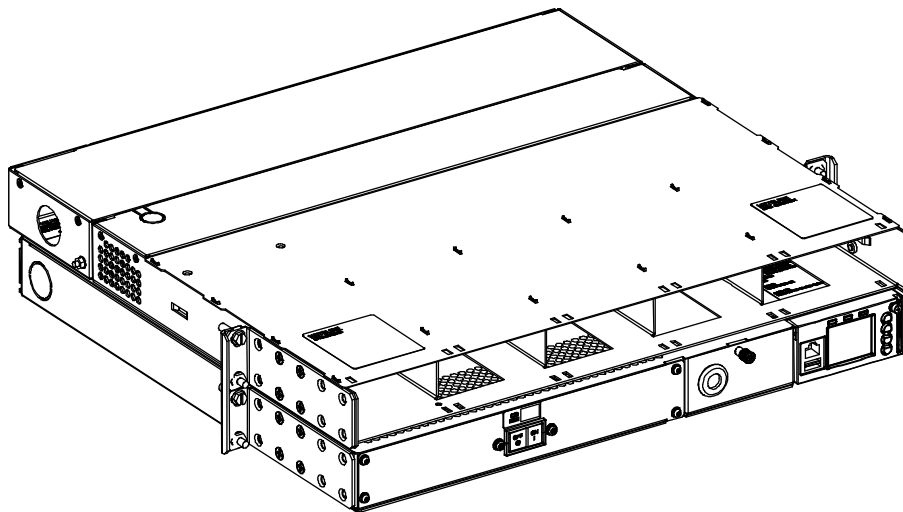

**List 01E: Inverter System, 19", up to 6 kVA maximum, Bulk Output**

**Features**

Provides a bulk output inverter system consisting of the following factory packaged components.

- ◆ Two (2) 5-position inverter module mounting shelves.
- ◆ One (1) 1U bulk output AC distribution shelf (includes one 70 A circuit breaker).
- ◆ Accepts one (1) NCU Controller.
- ◆ Includes the IB4 board (provides a network connection point for NCU remote access).
- ◆ Includes the IB2 controller interface board (provides eight (8) programmable form C- relay outputs, eight (8) programmable binary inputs, and two (2) temperature inputs).
- ◆ Includes the EPO (Emergency Power Off) board which provides the EPO function.
- ◆ Includes the customer interface board (see Figure 8).

**Restrictions**

Mounts in a 19" wide relay rack.

Maximum system output power is 6 kVA at 40 °C.

Maximum system output power is 3 kVA at 65 °C.

Output load not to exceed 80% (56 A) of rated value of 70 A circuit breaker at 40 °C and 65 °C.

**Ordering Notes**

- 1) Order one (1) NCU Controller P/N 1M830BNA (see page 21).  
Also specify appropriate configuration file for your site.
- 2) Order up to five (5) inverter modules P/N 1I1201000 per inverter module mounting shelf (see page 23).
- 3) Order an inverter mounting position blank cover panel P/N SXA1100035/1 for each empty inverter mounting position in the system as desired (see page 23).
- 4) Order optional temperature probes for ambient and battery temperature monitoring as required. Refer to "Optional Temperature Probes" on page 22.
- 5) Order DC input lugs as required per "Crimp Lugs" on page 24.

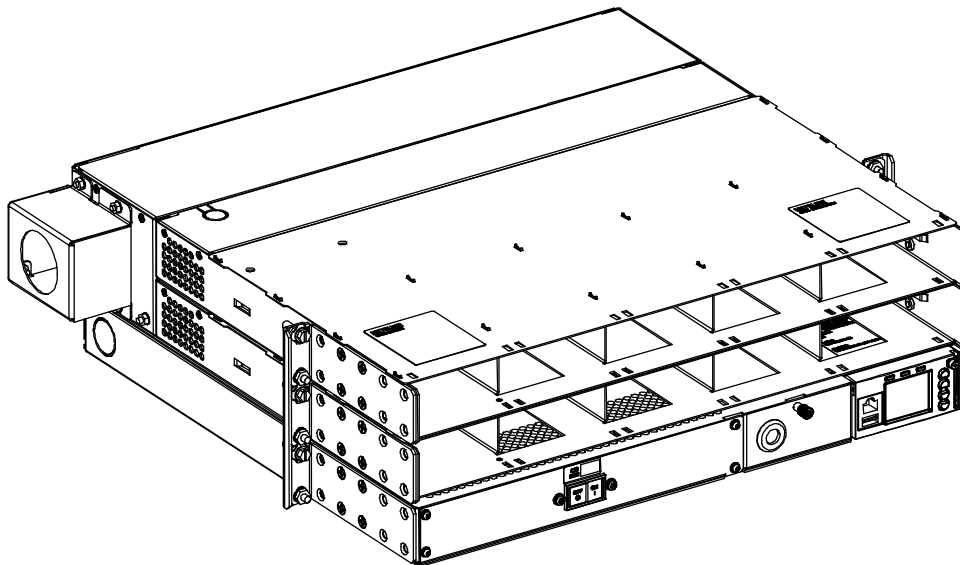



**List 02: Inverter System, 23", up to 6 kVA maximum (5.76 kVA per NEC Breaker De-rating), NEMA Output**

**Features**

Provides a NEMA output inverter system consisting of the following factory packaged components.

- ◆ One (1) 6-position inverter module mounting shelf.
- ◆ One (1) 1U NEMA output AC distribution shelf (includes four 15 A circuit breakers).
- ◆ Accepts one (1) NCU Controller.
- ◆ Includes the IB4 board which provides a network connection point for NCU remote access.
- ◆ Includes the IB2 controller interface board (provides eight (8) programmable form C- relay outputs, eight (8) programmable binary inputs, and two (2) temperature inputs).
- ◆ Includes the EPO (Emergency Power Off) board which provides the EPO function.
- ◆ Includes the customer interface board (see Figure 8).

**Restrictions**

Mounts in a 23" wide relay rack.

Maximum system output power is 5.76 kVA at 40 °C.

Maximum system output power is 3 kVA at 65 °C.

Output load per 15 A NEMA outlet not to exceed 80% (12 A) of rated value of circuit breaker at 40 °C and 65 °C.

**Ordering Notes**

- 1) Order one (1) NCU Controller P/N 1M830BNA (see page 21).  
Also specify appropriate configuration file for your site.
- 2) Order up to six (6) inverter modules P/N 111201000 per inverter module mounting shelf (see page 23).
- 3) Order an inverter mounting position blank cover panel P/N SXA1100035/1 for each empty inverter mounting position in the system as desired (see page 23).
- 4) Order optional temperature probes for ambient and battery temperature monitoring as required. Refer to "Optional Temperature Probes" on page 22.
- 5) Order DC input lugs as required per "Crimp Lugs" on page 24.

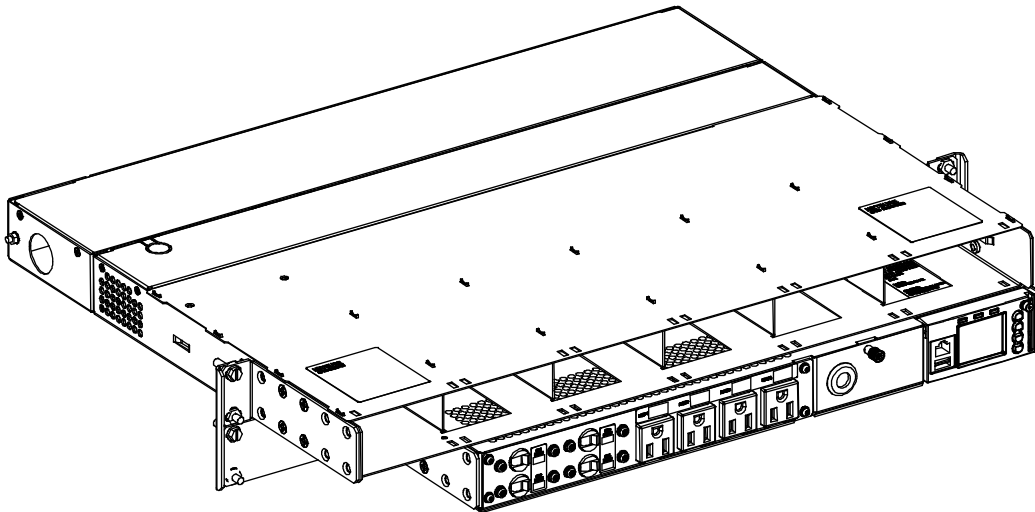

**List 02E: Inverter System, 23", up to 6 kVA maximum (5.76 kVA per NEC Breaker De-rating), NEMA Output**

**Features**

Provides a NEMA output inverter system consisting of the following factory packaged components.

- ◆ Two (2) 6-position inverter module mounting shelves.
- ◆ One (1) 1U NEMA output AC distribution shelf (includes four 15 A circuit breakers).
- ◆ Accepts one (1) NCU Controller.
- ◆ Includes the IB4 board which provides a network connection point for NCU remote access.
- ◆ Includes the IB2 controller interface board (provides eight (8) programmable form C- relay outputs, eight (8) programmable binary inputs, and two (2) temperature inputs).
- ◆ Includes the EPO (Emergency Power Off) board which provides the EPO function.
- ◆ Includes the customer interface board (see Figure 8).

**Restrictions**

Mounts in a 23" wide relay rack.

Maximum system output power is 5.76 kVA at 40 °C.

Maximum system output power is 3 kVA at 65 °C.

Output load per 15 A NEMA outlet not to exceed 80% (12 A) of rated value of circuit breaker at 40 °C and 65 °C.

**Ordering Notes**

- 1) Order one (1) NCU Controller P/N 1M830BNA (see page 21).  
Also specify appropriate configuration file for your site.
- 2) Order up to six (6) inverter modules P/N 111201000 per inverter module mounting shelf (see page 23).
- 3) Order an inverter mounting position blank cover panel P/N SXA1100035/1 for each empty inverter mounting position in the system as desired (see page 23).
- 4) Order optional temperature probes for ambient and battery temperature monitoring as required. Refer to "Optional Temperature Probes" on page 22.
- 5) Order DC input lugs as required per "Crimp Lugs" on page 24.

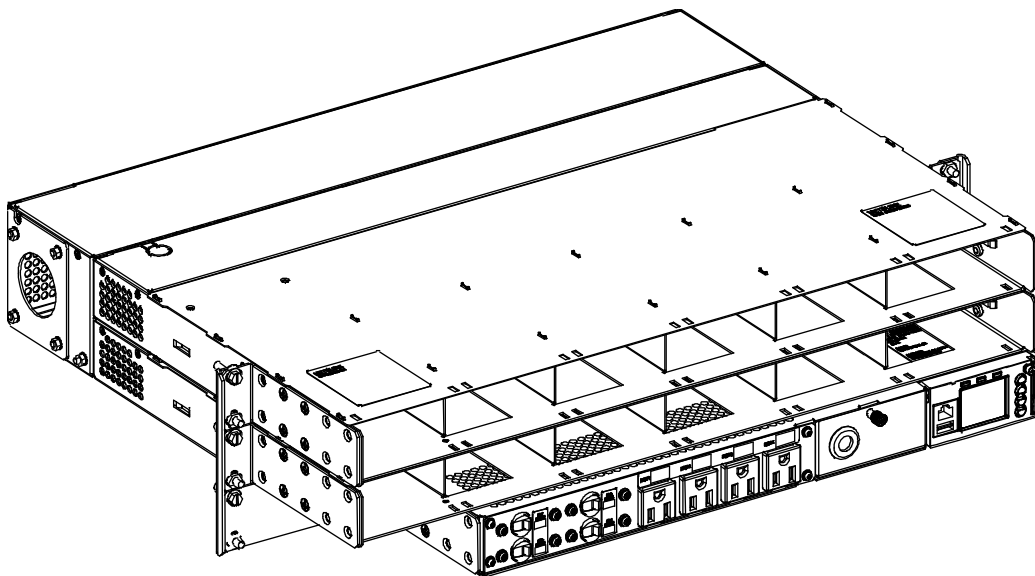

**List 03: Inverter System, 19", up to 10 kVA maximum, Bulk Output**

**Features**

Provides a bulk output inverter system consisting of the following factory packaged components.

- ◆ Two (2) 5-position inverter module mounting shelves.
- ◆ One (1) 2U bulk output AC distribution shelf (includes two 70 A circuit breakers).
- ◆ Accepts one (1) NCU Controller.
- ◆ Includes the IB4 board (provides a network connection point for NCU remote access).
- ◆ Includes the IB2 controller interface board (provides eight (8) programmable form C- relay outputs, eight (8) programmable binary inputs, and two (2) temperature inputs).
- ◆ Includes the EPO (Emergency Power Off) board which provides the EPO function.
- ◆ Includes the customer interface board (see Figure 8).

**Restrictions**

Mounts in a 19" wide relay rack.

Maximum system output power is 10 kVA at 40 °C.

Maximum system output power is 5 kVA at 65 °C.

Output load not to exceed 80% (56 A) of rated value of each 70 A circuit breaker at 40 °C and 65 °C.

**Ordering Notes**

- 1) Order one (1) NCU Controller P/N 1M830BNA (see page 21).  
Also specify appropriate configuration file for your site.
- 2) Order up to five (5) inverter modules P/N 1I1201000 per inverter module mounting shelf (see page 23).
- 3) Order an inverter mounting position blank cover panel P/N SXA1100035/1 for each empty inverter mounting position in the system as desired (see page 23).
- 4) Order optional temperature probes for ambient and battery temperature monitoring as required. Refer to "Optional Temperature Probes" on page 22.
- 5) Order DC input lugs as required per "Crimp Lugs" on page 24.

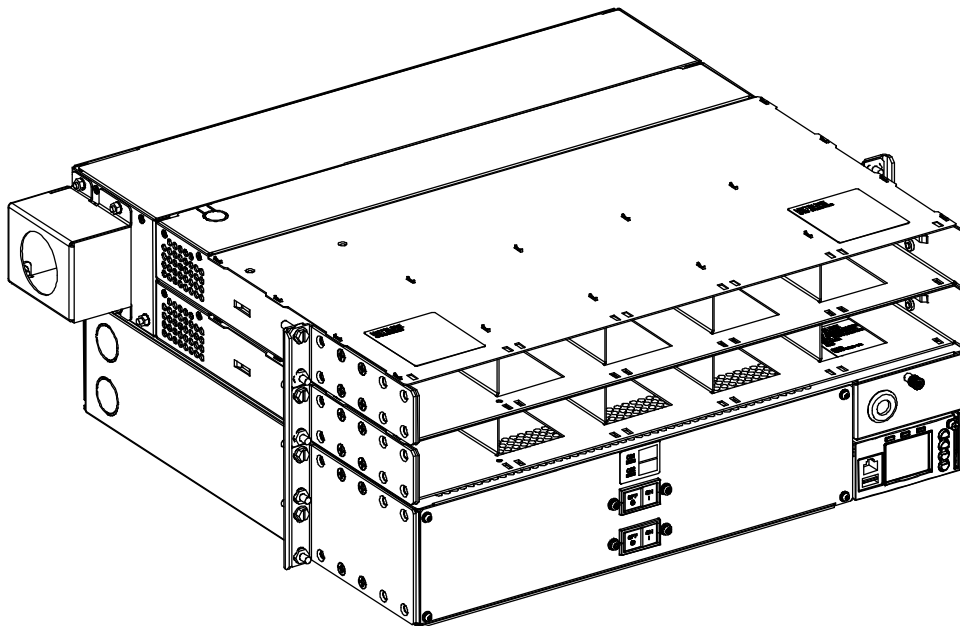

**List 03E: Inverter System, 19", up to 12 kVA maximum, Bulk Output**

**Features**

Provides a bulk output inverter system consisting of the following factory packaged components.

- ◆ Three (3) 5-position inverter module mounting shelves.
- ◆ One (1) 2U bulk output AC distribution shelf (includes two 70 A circuit breakers).
- ◆ Accepts one (1) NCU Controller.
- ◆ Includes the IB4 board (provides a network connection point for NCU remote access).
- ◆ Includes the IB2 controller interface board (provides eight (8) programmable form C- relay outputs, eight (8) programmable binary inputs, and two (2) temperature inputs).
- ◆ Includes the EPO (Emergency Power Off) board which provides the EPO function.
- ◆ Includes the customer interface board (see Figure 8).

**Restrictions**

Mounts in a 19" wide relay rack.

Maximum system output power is 12 kVA at 40 °C.

Maximum system output power is 7.5 kVA at 65 °C.

Output load not to exceed 80% (56 A) of rated value of each 70 A circuit breaker at 40 °C and 65 °C.

**Ordering Notes**

- 1) Order one (1) NCU Controller P/N 1M830BNA (see page 21).  
Also specify appropriate configuration file for your site.
- 2) Order up to five (5) inverter modules P/N 1I1201000 per inverter module mounting shelf (see page 23).
- 3) Order an inverter mounting position blank cover panel P/N SXA1100035/1 for each empty inverter mounting position in the system as desired (see page 23).
- 4) Order optional temperature probes for ambient and battery temperature monitoring as required. Refer to "Optional Temperature Probes" on page 22.
- 5) Order DC input lugs as required per "Crimp Lugs" on page 24.

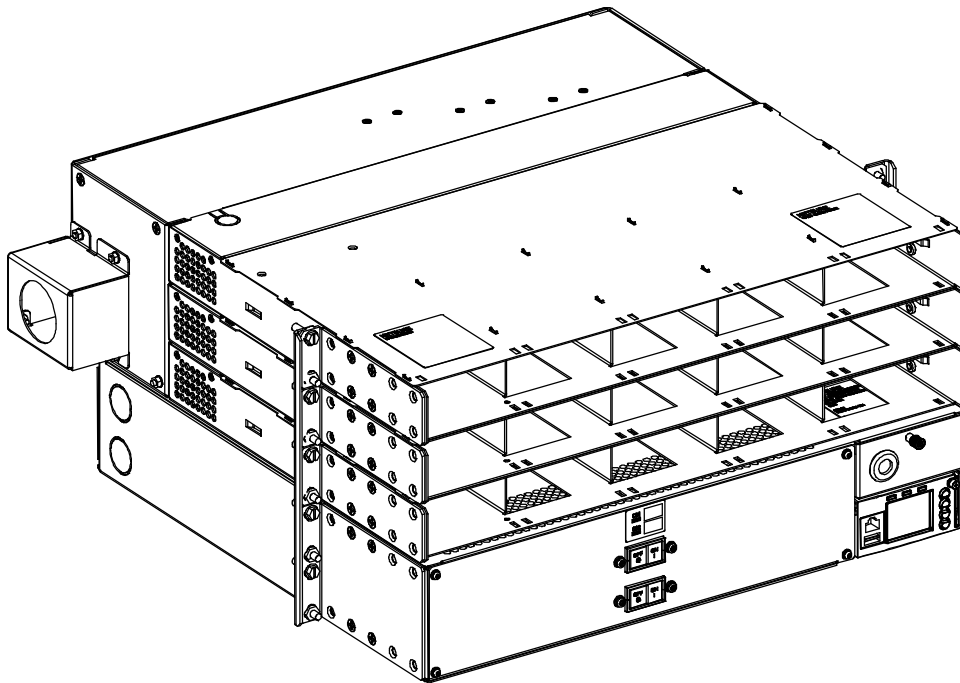

**List 04: Inverter System, 23", up to 12 kVA maximum (11.5 kVA per NEC Breaker De-rating), NEMA Output**

**Features**

Provides a NEMA output inverter system consisting of the following factory packaged components.

- ◆ Two (2) 6-position inverter module mounting shelves.
- ◆ One (1) 2U NEMA output AC distribution shelf (includes eight 15 A circuit breakers).
- ◆ Accepts one (1) NCU Controller.
- ◆ Includes the IB4 board (provides a network connection point for NCU remote access).
- ◆ Includes the IB2 controller interface board (provides eight (8) programmable form C- relay outputs, eight (8) programmable binary inputs, and two (2) temperature inputs).
- ◆ Includes the EPO (Emergency Power Off) board which provides the EPO function.
- ◆ Includes the customer interface board (see Figure 8).

**Restrictions**

Mounts in a 23" wide relay rack.

Maximum system output power is 11.5 kVA at 40 °C.

Maximum system output power is 6 kVA at 65 °C.

Output load per 15 A NEMA outlet not to exceed 80% (12 A) of rated value of circuit breaker at 40 °C and 65 °C.

**Ordering Notes**

- 1) Order one (1) NCU Controller P/N 1M830BNA (see page 21).  
Also specify appropriate configuration file for your site.
- 2) Order up to six (6) inverter modules P/N 111201000 per inverter module mounting shelf (see page 23).
- 3) Order an inverter mounting position blank cover panel P/N SXA1100035/1 for each empty inverter mounting position in the system as desired (see page 23).
- 4) Order optional temperature probes for ambient and battery temperature monitoring as required. Refer to "Optional Temperature Probes" on page 22.
- 5) Order DC input lugs as required per "Crimp Lugs" on page 24.

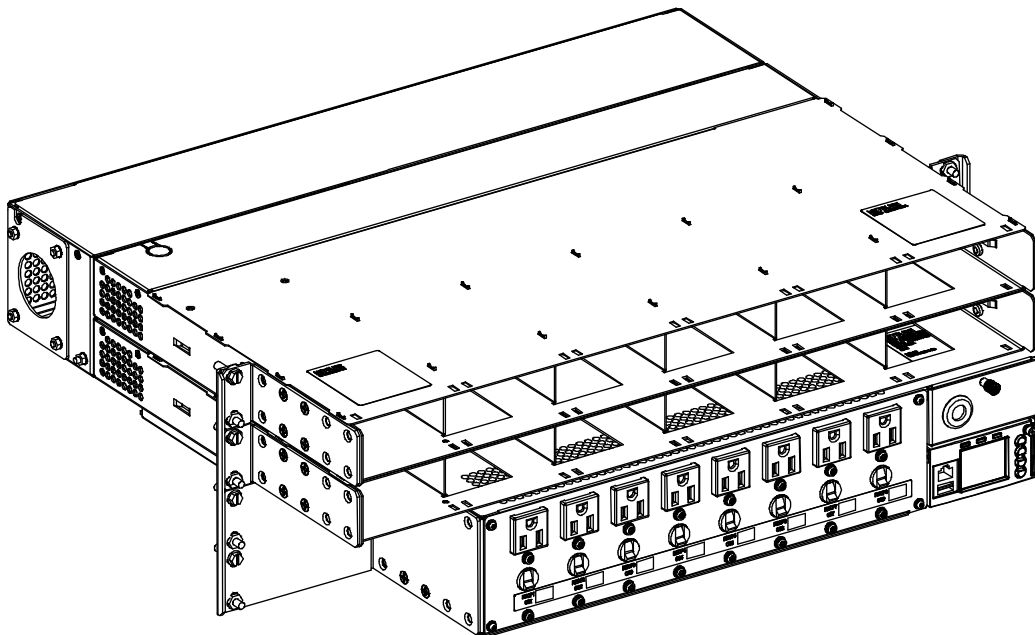

**List 04E: Inverter System, 23", up to 12 kVA maximum (11.5 kVA per NEC Breaker De-rating), NEMA Output**

**Features**

Provides a NEMA output inverter system consisting of the following factory packaged components.

- ◆ Three (3) 6-position inverter module mounting shelves.
- ◆ One (1) 2U NEMA output AC distribution shelf (includes eight 15 A circuit breakers).
- ◆ Accepts one (1) NCU Controller.
- ◆ Includes the IB4 board (provides a network connection point for NCU remote access).
- ◆ Includes the IB2 controller interface board (provides eight (8) programmable form C- relay outputs, eight (8) programmable binary inputs, and two (2) temperature inputs).
- ◆ Includes the EPO (Emergency Power Off) board which provides the EPO function.
- ◆ Includes the customer interface board (see Figure 8).

**Restrictions**

Mounts in a 23" wide relay rack.

Maximum system output power is 11.5 kVA at 40 °C.

Maximum system output power is 9 kVA at 65 °C.

Output load per 15 A NEMA outlet not to exceed 80% (12 A) of rated value of circuit breaker at 40 °C and 65 °C.

**Ordering Notes**

- 1) Order one (1) NCU Controller P/N 1M830BNA (see page 21).  
Also specify appropriate configuration file for your site.
- 2) Order up to six (6) inverter modules P/N 111201000 per inverter module mounting shelf (see page 23).
- 3) Order an inverter mounting position blank cover panel P/N SXA1100035/1 for each empty inverter mounting position in the system as desired (see page 23).
- 4) Order optional temperature probes for ambient and battery temperature monitoring as required. Refer to "Optional Temperature Probes" on page 22.
- 5) Order DC input lugs as required per "Crimp Lugs" on page 24.

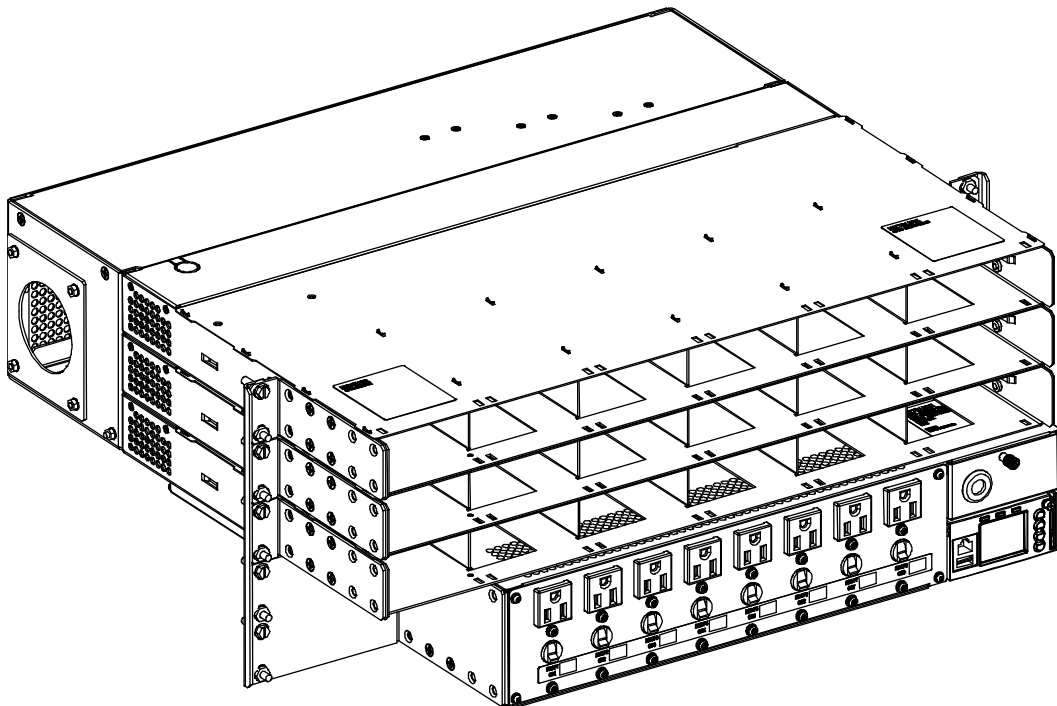

**List 05: Inverter System, 19", up to 15 kVA maximum, Bulk Output - DC INPUT ONLY**

**Features**

Provides a bulk output inverter system consisting of the following factory packaged components.

- ◆ Three (3) 5-position inverter module mounting shelves.
- ◆ Two (1) 2U bulk output AC distribution shelves (each includes two 70 A circuit breakers).
- ◆ Accepts one (1) NCU Controller.
- ◆ Includes the IB4 board (provides a network connection point for NCU remote access).
- ◆ Includes the IB2 controller interface board (provides eight (8) programmable form C- relay outputs, eight (8) programmable binary inputs, and two (2) temperature inputs).
- ◆ Includes the EPO (Emergency Power Off) board which provides the EPO function.
- ◆ Includes the customer interface board (see Figure 8).

**Restrictions**

Mounts in a 19" wide relay rack.

Maximum system output power is 15 kVA at 40 °C.

Maximum system output power is 7.5 kVA at 65 °C.

Output load not to exceed 80% (56 A) of rated value of each 70 A circuit breaker at 40 °C and 65 °C.

**Ordering Notes**

- 1) Order one (1) NCU Controller P/N 1M830BNA (see page 21).  
Also specify appropriate configuration file for your site.
- 2) Order up to five (5) inverter modules P/N 111201000 per inverter module mounting shelf (see page 23).
- 3) Order an inverter mounting position blank cover panel P/N SXA1100035/1 for each empty inverter mounting position in the system as desired (see page 23).
- 4) Order optional temperature probes for ambient and battery temperature monitoring as required. Refer to "Optional Temperature Probes" on page 22.
- 5) Order DC input lugs as required per "Crimp Lugs" on page 24.

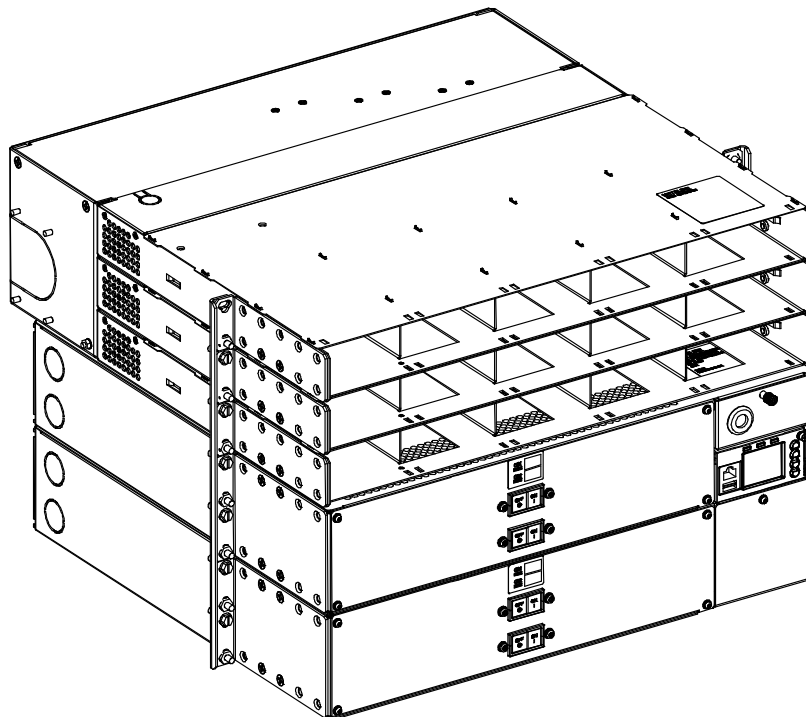

**List 05E: Inverter System, 19", up to 20 kVA maximum, Bulk Output - DC INPUT ONLY**

**Features**

Provides a bulk output inverter system consisting of the following factory packaged components.

- ◆ Four (4) 5-position inverter module mounting shelves.
- ◆ Two (1) 2U bulk output AC distribution shelves (each includes two 70 A circuit breakers).
- ◆ Accepts one (1) NCU Controller.
- ◆ Includes the IB4 board (provides a network connection point for NCU remote access).
- ◆ Includes the IB2 controller interface board (provides eight (8) programmable form C- relay outputs, eight (8) programmable binary inputs, and two (2) temperature inputs).
- ◆ Includes the EPO (Emergency Power Off) board which provides the EPO function.
- ◆ Includes the customer interface board (see Figure 8).

**Restrictions**

Mounts in a 19" wide relay rack.

Maximum system output power is 20 kVA at 40 °C.

Maximum system output power is 10 kVA at 65 °C.

Output load not to exceed 80% (56 A) of rated value of each 70 A circuit breaker at 40 °C and 65 °C.

**Ordering Notes**

- 1) Order one (1) NCU Controller P/N 1M830BNA (see page 21).  
Also specify appropriate configuration file for your site.
- 2) Order up to five (5) inverter modules P/N 111201000 per inverter module mounting shelf (see page 23).
- 3) Order an inverter mounting position blank cover panel P/N SXA1100035/1 for each empty inverter mounting position in the system as desired (see page 23).
- 4) Order optional temperature probes for ambient and battery temperature monitoring as required. Refer to "Optional Temperature Probes" on page 22.
- 5) Order DC input lugs as required per "Crimp Lugs" on page 24.

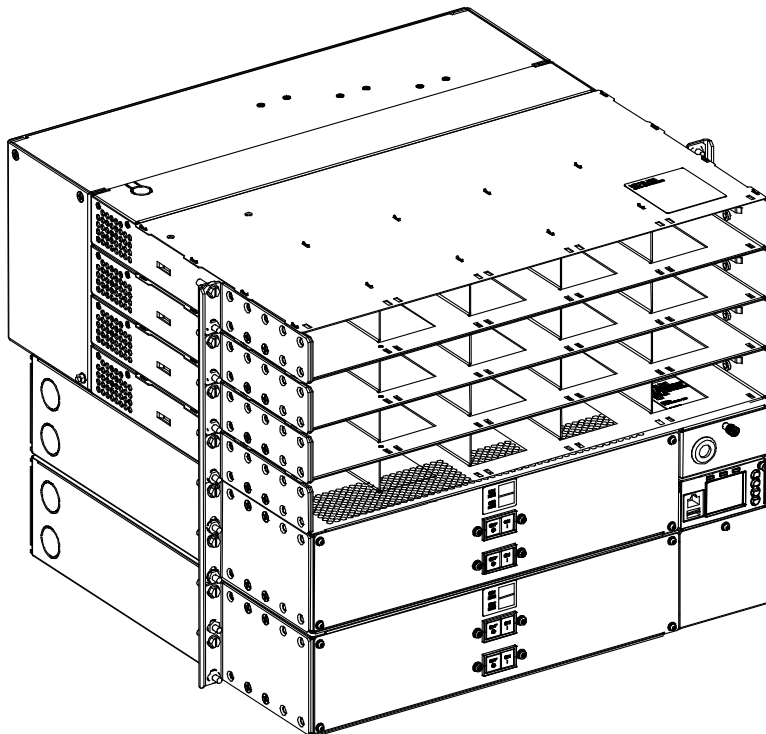



**List 06: Inverter System, 23", up to 18 kVA maximum (18 kVA per NEC Breaker De-rating), NEMA Output**

**Features**

Provides a NEMA output inverter system consisting of the following factory packaged components.

- ◆ Three (3) 6-position inverter module mounting shelves.
- ◆ Two (2) 2U NEMA output AC distribution shelves (each includes eight 15 A circuit breakers).
- ◆ Accepts one (1) NCU Controller.
- ◆ Includes the IB4 board (provides a network connection point for NCU remote access).
- ◆ Includes the IB2 controller interface board (provides eight (8) programmable form C- relay outputs, eight (8) programmable binary inputs, and two (2) temperature inputs).
- ◆ Includes the EPO (Emergency Power Off) board which provides the EPO function.
- ◆ Includes the customer interface board (see Figure 8).

**Restrictions**

Mounts in a 23" wide relay rack.

Maximum system output power is 18 kVA at 40 °C.

Maximum system output power is 9 kVA at 65 °C.

Output load per 15 A NEMA outlet not to exceed 80% (12 A) of rated value of circuit breaker at 40 °C and 65 °C.

**Ordering Notes**

- 1) Order one (1) NCU Controller P/N 1M830BNA (see page 21).  
Also specify appropriate configuration file for your site.
- 2) Order up to six (6) inverter modules P/N 111201000 per inverter module mounting shelf (see page 23).
- 3) Order an inverter mounting position blank cover panel P/N SXA1100035/1 for each empty inverter mounting position in the system as desired (see page 23).
- 4) Order optional temperature probes for ambient and battery temperature monitoring as required. Refer to "Optional Temperature Probes" on page 22.
- 5) Order DC input lugs as required per "Crimp Lugs" on page 24.

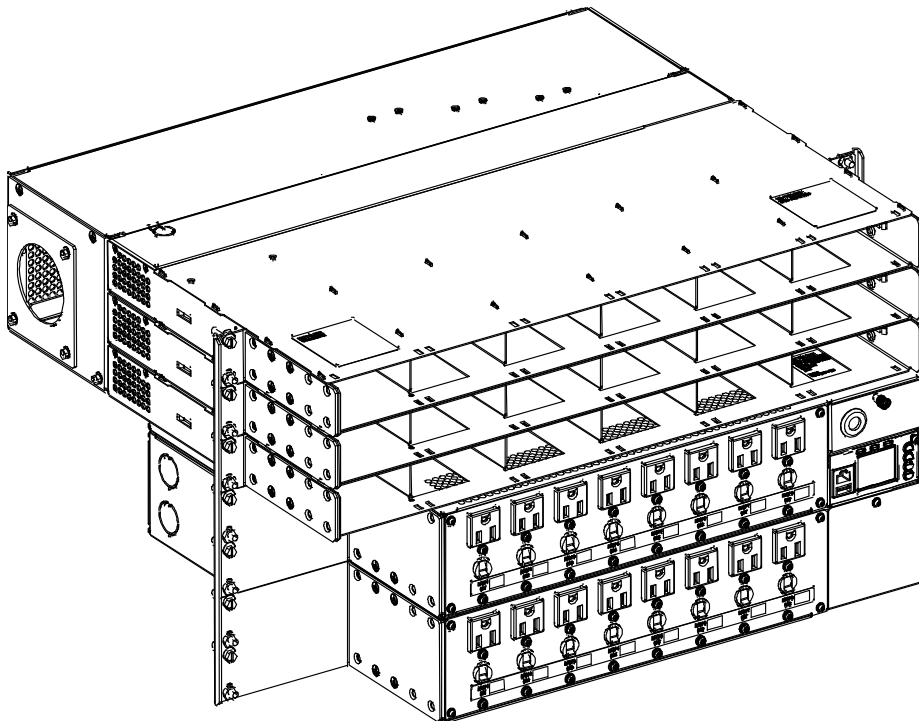

**List 06E: Inverter System, 23", up to 24 kVA maximum (23 kVA per NEC Breaker De-rating), NEMA Output**

**Features**

Provides a NEMA output inverter system consisting of the following factory packaged components.

- ◆ Four (4) 6-position inverter module mounting shelves.
- ◆ Two (2) 2U NEMA output AC distribution shelves (each includes eight 15 A circuit breakers).
- ◆ Accepts one (1) NCU Controller.
- ◆ Includes the IB4 board (provides a network connection point for NCU remote access).
- ◆ Includes the IB2 controller interface board (provides eight (8) programmable form C- relay outputs, eight (8) programmable binary inputs, and two (2) temperature inputs).
- ◆ Includes the EPO (Emergency Power Off) board which provides the EPO function.
- ◆ Includes the customer interface board (see Figure 8).

**Restrictions**

Mounts in a 23" wide relay rack.

Maximum system output power is 23 kVA at 40 °C.

Maximum system output power is 12 kVA at 65 °C.

Output load per 15 A NEMA outlet not to exceed 80% (12 A) of rated value of circuit breaker at 40 °C and 65 °C.

**Ordering Notes**

- 1) Order one (1) NCU Controller P/N 1M830BNA (see page 21).  
Also specify appropriate configuration file for your site.
- 2) Order up to six (6) inverter modules P/N 111201000 per inverter module mounting shelf (see page 23).
- 3) Order an inverter mounting position blank cover panel P/N SXA1100035/1 for each empty inverter mounting position in the system as desired (see page 23).
- 4) Order optional temperature probes for ambient and battery temperature monitoring as required. Refer to "Optional Temperature Probes" on page 22.
- 5) Order DC input lugs as required per "Crimp Lugs" on page 24.

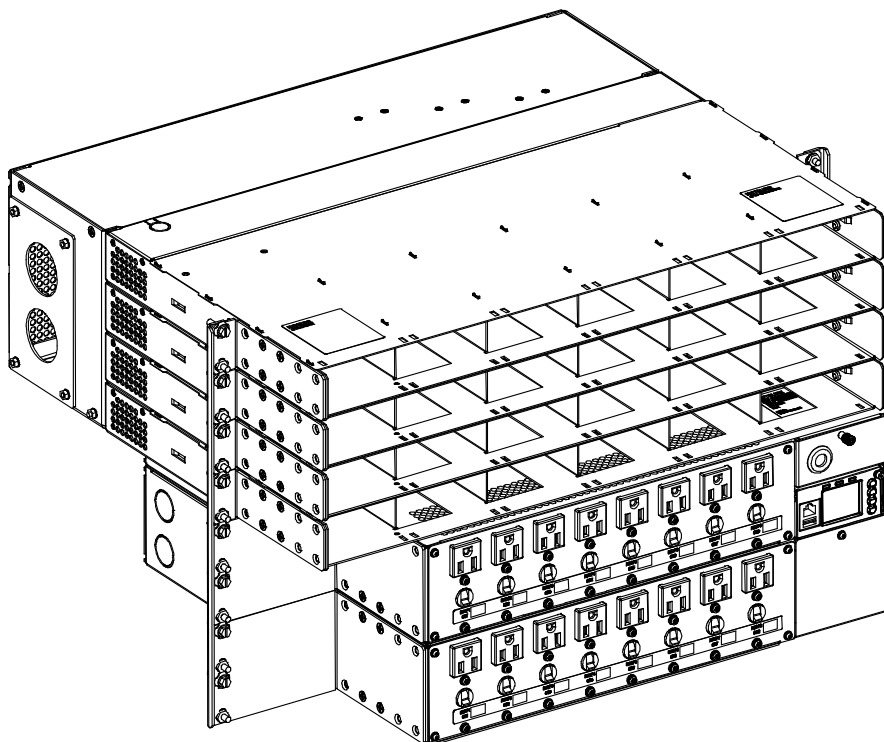

**List 07: Inverter System, 19", up to 5 kVA maximum, NEMA Output**

**Features**

Provides a NEMA output inverter system consisting of the following factory packaged components.

- ◆ One (1) 5-position inverter module mounting shelf.
- ◆ One (1) 1U NEMA output AC distribution shelf (includes four 15 A circuit breakers).
- ◆ Accepts one (1) NCU Controller.
- ◆ Includes the IB4 board (provides a network connection point for NCU remote access).
- ◆ Includes the IB2 controller interface board (provides eight (8) programmable form C- relay outputs, eight (8) programmable binary inputs, and two (2) temperature inputs).
- ◆ Includes the EPO (Emergency Power Off) board which provides the EPO function.
- ◆ Includes the customer interface board (see Figure 8).

**Restrictions**

Mounts in a 19" wide relay rack.

Maximum system output power is 5 kVA at 40 °C.

Maximum system output power is 2.5 kVA at 65 °C.

Output load per 15 A NEMA outlet not to exceed 80% (12 A) of rated value of circuit breaker at 40 °C and 65 °C.

**Ordering Notes**

- 1) Order one (1) NCU Controller P/N 1M830BNA (see page 21). Also specify appropriate configuration file for your site.
- 2) Order up to five (5) inverter modules P/N 1I1201000 per inverter module mounting shelf (see page 23).
- 3) Order an inverter mounting position blank cover panel P/N SXA1100035/1 for each empty inverter mounting position in the system as desired (see page 23).
- 4) Order optional temperature probes for ambient and battery temperature monitoring as required. Refer to "Optional Temperature Probes" on page 22.
- 5) Order DC input lugs as required per "Crimp Lugs" on page 24.

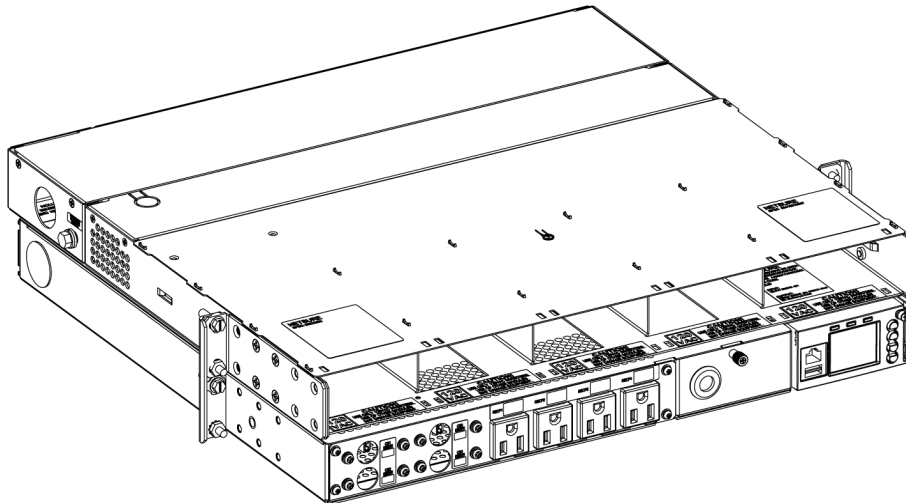

**List 08: Inverter System, 19", up to 10 kVA maximum, NEMA Output**

**Features**

Provides a NEMA output inverter system consisting of the following factory packaged components.

- ◆ Two (2) 5-position inverter module mounting shelves.
- ◆ One (1) 2U NEMA output AC distribution shelf (includes eight 15 A circuit breakers).
- ◆ Accepts one (1) NCU Controller.
- ◆ Includes the IB4 board (provides a network connection point for NCU remote access).
- ◆ Includes the IB2 controller interface board (provides eight (8) programmable form C- relay outputs, eight (8) programmable binary inputs, and two (2) temperature inputs).
- ◆ Includes the EPO (Emergency Power Off) board which provides the EPO function.
- ◆ Includes the customer interface board (see Figure 8).

**Restrictions**

Mounts in a 19" wide relay rack.

Maximum system output power is 10 kVA at 40 °C.

Maximum system output power is 5 kVA at 65 °C.

Output load per 15 A NEMA outlet not to exceed 80% (12 A) of rated value of circuit breaker at 40 °C and 65 °C.

**Ordering Notes**

- 1) Order one (1) NCU Controller P/N 1M830BNA (see page 21). Also specify appropriate configuration file for your site.
- 2) Order up to ten (10) inverter modules P/N 111201000 per inverter module mounting shelf (see page 23).
- 3) Order an inverter mounting position blank cover panel P/N SXA1100035/1 for each empty inverter mounting position in the system as desired (see page 23).
- 4) Order optional temperature probes for ambient and battery temperature monitoring as required. Refer to "Optional Temperature Probes" on page 22.
- 5) Order DC input lugs as required per "Crimp Lugs" on page 24.

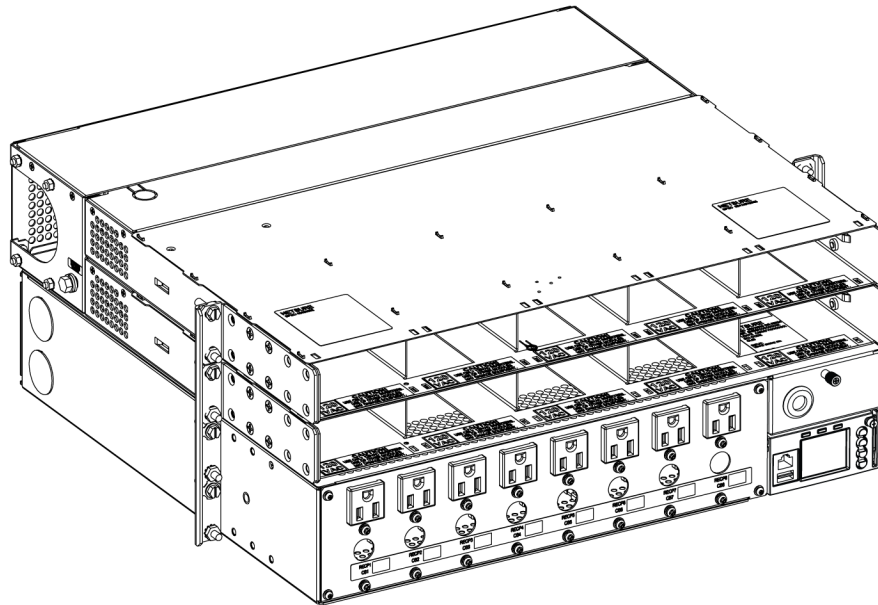

## ACCESSORY DESCRIPTIONS

### Controller

#### **NCU (NetSure™ Control Unit) Controller, P/N 1M830BNA**

##### **Features**

- ◆ NCU Controller, Model M830BNA (Spec. No. 1M830BNA).
- ◆ Factory programmed with the configuration file specified when ordered.  
**Note:** The controller is provided with the factory default configuration unless otherwise specified.  
**Note:** Contact us for custom NCU configurations.
- ◆ Refer to the NCU Controller Instructions (UM1M830BNA) for more information.

##### **Restrictions**

Only one (1) controller per inverter system is required.

##### **Ordering Notes**

- 1) Order one (1) NCU controller per inverter system, P/N 1M830BNA.  
**Note:** If the inverter system is being added to an existing Vertiv™ NetSure™ Power System with an NCU controller, a Rev B version NCU should be utilized in the DC power system.
- 2) Order optional temperature probes for ambient and battery temperature monitoring as required. Refer to “Optional Temperature Probes” on page 22.
- 3) Order optional SM-Temp Temperature Concentrator (Supervisory Module for Temperature Probes) as desired (shipped loose) (see page 23). Also order SM-Temp CAN Bus Interface Cable, P/N 562868, and “SM-Temp Jumpers, P/N 552888” (see page 23) as required.  
**Note:** A system can have up to (8) SM-Temp modules (each of which can accept up to eight temperature probes) that can be used in the power system for ambient and battery monitoring.
- 4) Ordering an NCU for replacing an NCU or as a spare NCU.

If the NCU is to be used as a replacement in a specific system, it should be ordered with the same configuration file as the original NCU controller. This is identified by a six-digit number. If the controller part number ends with a six-digit number, for example, 1M830BNA559242, the configuration file number is the last six characters. If the part number does not have these characters, the configuration file number can be found on the controller nameplate – “Programmed with Configuration File #####”. The controller may also have a Unique Identification Number (UIN). This number indicates that certain parameters were set at the factory to match the controller to the options selected with the power plant. If the controller has a UIN, the plant will have shipped with a USB drive labelled with the UIN. The UIN label may also be located near the controller slot in the system. If the controller has a UIN, provide this UIN number, along with the configuration number, when ordering so that the new controller will match that of the original controller shipped with the system. The user manual provided with the controller provides instructions for replacing and programming the controller. It is important to follow these instructions carefully. The user manual also provides instructions for saving certain controller files that are created when changes are made to the system after leaving the factory. These files can be programmed into the replacement controller so it can match the latest saved state of the original controller.

If the NCU is being ordered as a spare part for any of a group of power plants, the same procedure can be followed. If the replacement controller’s configuration does not match that of the original controller, the original files can be retrieved from the USB drive shipped with the plant, if available. If the USB drive is not available, contact the factory or technical assistance center to obtain a copy of the original configuration file (all package) so it can be programmed into the new controller.

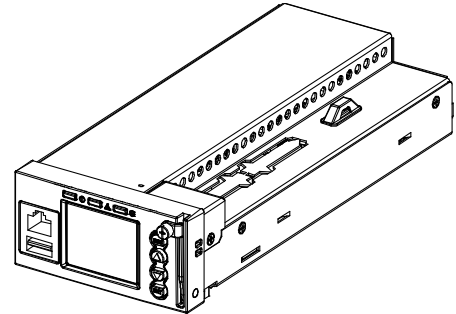

### Optional Temperature Probes

#### Features

- ◆ Up to two (2) temperature probes can be connected to the IB2 (Controller Interface Board). The temperature probes can be programmed to monitor ambient temperature and/or battery temperature.
- ◆ The temperature sensor end of the probe contains a tab with a 5/16" clearance hole for mounting.
- ◆ Temperature probes can also be used with the optional SM-Temp Temperature Concentrator.

#### Restrictions

A temperature probe programmed to monitor battery temperature should be mounted on the negative post of a battery cell to sense battery temperature. A temperature probe programmed to monitor ambient temperature should be mounted in a convenient location, away from direct sources of heat or cold.

#### Ordering Notes

- 1) Order temperature probes as required. Note that each temperature probe consists of two or three pieces which plug together to make a complete probe (see the following illustration). For a complete temperature probe, order one (1) P/N 552992 (10.3 meters) or one (1) P/N 556155 (3.3 meters). If additional length is required, order temperature probe extension cable P/N 04119122 (10 meters).
- 2) If more probes are desired, order one or more SM-Temp Temperature Concentrator, P/N 547490. See "SM-Temp Temperature Concentrator, P/N 547490" on page 23.

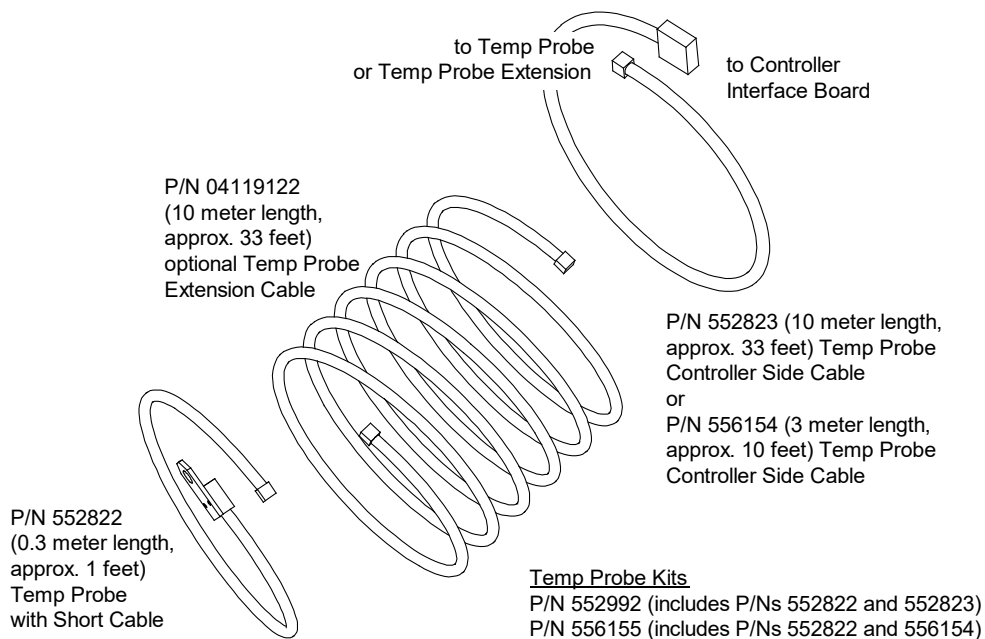

## Optional SM-Temp Temperature Concentrator

### SM-Temp Temperature Concentrator, P/N 547490

#### **Features**

- ◆ Allows for multiple temperature probes to be used for ambient temperature monitoring and/or battery temperature monitoring.
- ◆ Provides (8) temperature probe inputs per SM-Temp unit.
- ◆ Can cascade up to (8) SM-Temp units, connecting up to sixty-four (64) temperature probes.
- ◆ The SM-Temp Concentrator is connected at the end of the NCU CAN bus. Via the CAN Bus, the NCU reads each temperature probe from each SM-Temp Concentrator.
- ◆ Refer to the SM-Temp Temperature Concentrator Instructions (UM547490) for more information.

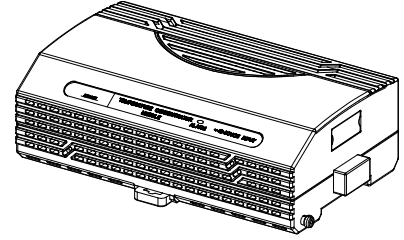

#### **Ordering Notes**

- 1) Order SM-Temp Temperature Concentrator, P/N 547490, as required.
- 2) Order up to (8) temperature probes for each concentrator. See “Optional Temperature Probes” on page 22.
- 3) Order one (1) SM-Temp CAN Bus Interface Cable, P/N 562868, to connect the SM-Temp into the controller’s CAN bus.
- 4) Order SM-Temp jumpers (P/N 552888) to interconnect SM-Temp units, as required. See “SM-Temp Jumpers, P/N 552888” on page 23.

### SM-Temp Jumpers, P/N 552888

#### **Features**

- ◆ Provides 20’ of 18 AWG solid red / black twisted pair cable and three (3) wire splices for connecting the CAN bus of multiple SM-Temp modules together.

#### **Ordering Notes**

- 1) Order P/N 552888 as required.

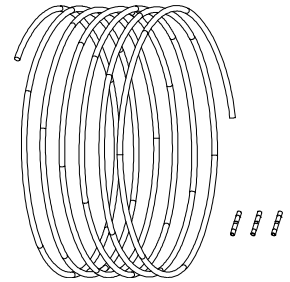

## Inverter

### Inverter Module, P/N 111201000

#### **Features**

- ◆ Model I120-1000, Spec. No. 111201000, 120 VAC, 1 kVA/1 kW at 45 °C and 120 VAC / 0.5 kVA at 65 °C inverter module.
- ◆ Refer to the Inverter Instructions (UM111201000) for more information.

#### **Ordering Notes**

- 1) Order by P/N 111201000 as required.

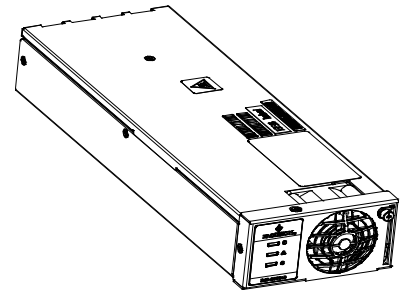

### Inverter Module Mounting Position Blank Cover Panel, P/N SXA1100035/1

#### **Features**

- ◆ Covers one (1) unused inverter mounting position.

#### **Ordering Notes**

- 1) Order by P/N SXA1100035/1 as required. Order an inverter module mounting position blank cover panel for each empty inverter module mounting position in the system, as desired.

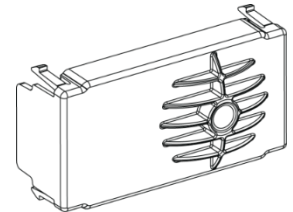

**19” to 23” Relay Rack Adapter Brackets**

- ◆ 563148 N/A 1U tall – two brackets (one for each side) and four screws included
  
- ◆ 563146 N/A 2U tall – two brackets (one for each side) and four screws included

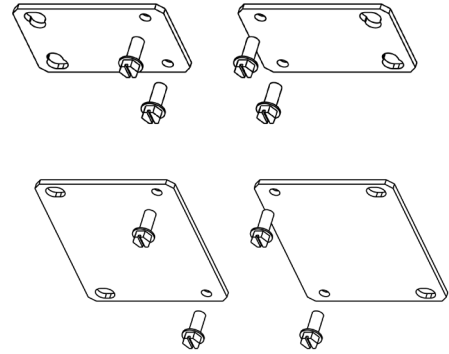

**Crimp Lugs**

**Standard Crimp Lug Tables**

**Features**

- ◆ For use on the -48 VDC nominal input busbars.

**Ordering Notes**

- 1) Specify part number from Table 2 for desired lead size.

Lead Size	Part Number	
14-10 AWG	245342300	
8 AWG	245390200	
6 AWG	245346700	

Table 2  
Crimp Lug  
Two-Hole, 1/4” Bolt Clearance Hole, 5/8” Centers

**User Replaceable Components**

**Ordering Notes**

- 1) Refer to Table 3.

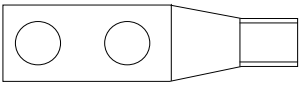
Item	Part Number
Inverter Module	11201000
NCU Controller	1M830BNA
Temp Probe Sensor	552822
Controller IB2 Interface Board	MA4C5U31
Controller IB4 (second Ethernet port) Board	558076

Table 3  
User Replaceable Components



## RECOMMENDED WIRE SIZES, BRANCH CIRCUIT PROTECTION, CRIMP LUGS, AND WIRING ILLUSTRATIONS

### Relay Rack Frame Grounding Requirements

For relay rack grounding requirements, refer to the current edition of the American National Standards Institute (ANSI) approved National Fire Protection Association's (NFPA) National Electrical Code (NEC), applicable local codes, and your specific site requirements.

A customer's grounding network lead can be attached to the top of each relay rack. Provision is made for installing a lead with a two-hole lug that has 1/4" bolt clearance holes on 5/8" centers. Refer to Table 2 for lug selection.

### System Shelf Frame Grounding

For system shelf grounding requirements, refer to the current edition of the American National Standards Institute (ANSI) approved National Fire Protection Association's (NFPA) National Electrical Code (NEC), applicable local codes, and your specific site requirements.

A connection to the customer's grounding network or main grounding electrode is made using a grounding electrode conductor terminated on the system enclosure. System shelf grounding is accomplished through ground washers properly installed on the relay rack mounting brackets.

Note: A direct connection to the main grounding electrode is required even if the relay rack or cabinet frame is already grounded. A 1/4-20 frame ground point (marked "Grounding Electrode Terminal") is located on the rear of the system near the AC input (see Figure 1 for typical location of the Grounding Electrode Terminal). Terminal hardware is shipped loose with the system and must be installed after the system is mounted to the relay rack or cabinet frame. Provide a grounding electrode conductor to this point using a copper conductor that complies with National Electrical Code (NEC) for ampacity. Refer to Table 4 for ground lead size recommendation and lug selection.

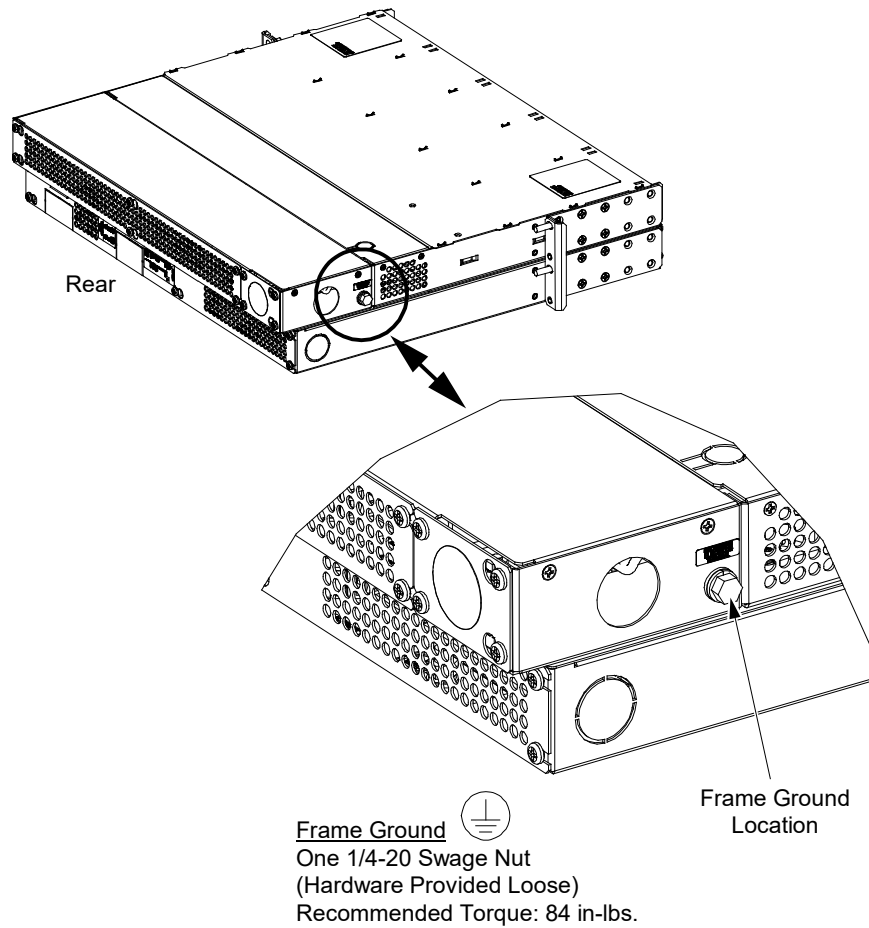

Figure 1  
Typical Location of Grounding Electrode Terminal

System Size	Ground Lead Size	Lug Part Number	
One (1) Inverter Shelf	8 AWG	245350400	
Two (2) Inverter Shelves	6 AWG	245350600	
Three (3) or Four (4) Inverter Shelves	2 AWG	245350800	

Table 4  
Grounding Electrode Terminal Crimp Lug  
(One-Hole, 1/4" Bolt Clearance Hole)

IMPORTANT NOTE:

Please see mandatory Customer Interface Board wiring outlined on page 40. The NCU and system will NOT operate without these connections!!

**AC Input Connections (Spec. No. 584130100 Lists 01, 01E, 02, 02E, 03, 03E, 04, 04E, 06, 06E, 07, and 08 - does NOT apply to Lists 05 and 05E)**

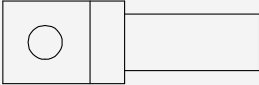
**AC Input Branch Circuit Protection and Wire Size Selection**

Refer to Table 5 for recommended wire sizes and branch circuit protection. Refer to Figure 2 for an illustration.

Spec. No. 584130100 Lists 01, 01E, 02, 02E, 03, 03E, 04, 04E, 06, 06E, 07, and 08 Inverter System Recommended AC Input Branch Circuit Protection and Wire Size							
Provides Input Terminations for “One AC Feed per Inverter System” (Nominal 120 VAC, Single Phase, 50 Hz / 60 Hz) (AC Input Information Does NOT Apply to Lists 05 and 05E - These Systems Are DC Input Only)							
List Number	Input Voltage	Input Current	Overcurrent Protection <sup>(1)</sup>		Conductor Wire Size <sup>(2) (3) (4)</sup>	EGC Wire Size	Conduit Size (in)
			OC PD Minimum	OC PD Maximum			
40 °C and 65 °C Ambient Temperature <sup>(5)</sup>							
List 01, 07	120 VAC	45 A	60 A	70 A	6 AWG	10 AWG	3/4"
List 01E	120 VAC	54 A	70 A	90 A	4 AWG	8 AWG	1-1/4"
List 02	120 VAC	54 A	70 A	90 A	4 AWG	8 AWG	3/4"
List 02E	120 VAC	54 A	70 A	90 A	4 AWG	8 AWG	1-1/4"
List 03, 08	120 VAC	90 A	125 A	125 A	2 AWG	6 AWG	1-1/4"
List 03E	120 VAC	108 A	150 A	150 A	1/0 AWG	6 AWG	1-1/4"
List 04	120 VAC	108 A	150 A	150 A	1/0 AWG	6 AWG	1-1/4"
List 04E	120 VAC	108 A	150 A	150 A	1/0 AWG	6 AWG	2"
List 06	120 VAC	162 A	225 A	250 A	1/0 AWG x 2 (parallel)	4 AWG	2"
List 06E	120 VAC	207 A	300 A	300 A	1/0 AWG x 2 (parallel)	6 AWG x 2 (1 per conduit)	1-1/4"x 2 (parallel)

- <sup>1</sup> The AC input branch circuit protective device should be of the time-delay or high inrush type.
- <sup>2</sup> Wire sizes based on recommendations of the American National Standards Institute (ANSI) approved National Fire Protection Association’s (NFPA) National Electrical Code (NEC). Table 310.15 (B) (16) for copper wire at 90 °C conductor temperature. For operation in countries where the NEC is not recognized, follow applicable codes.
- <sup>3</sup> Equipment grounding conductors must be provided with the AC input conductors supplied to the module mounting assembly. Frame ground terminals must be connected to earth ground, not power system neutral. Equipment grounding conductor size based on recommendations of the NEC Table 250-122 for copper wire. If aluminum or copper clad aluminum grounding conductor is used, refer to Table 250-122 for increased conductor size. For operation in countries where the NEC is not recognized, follow applicable codes.
- <sup>4</sup> THHN 90°C Wire.
- <sup>5</sup> Table values are based on full-power operation of inverter modules at 40 °C ambient temperature. For systems designed to operate in a 65 °C ambient environment, wire the system using the OCPD and field-wiring sizes as recommended for 40 °C ambient temperature due to the linear power derating of the inverter module between 45 °C and 65 °C. Refer to Section 1.2.1 (AC Input Ratings) and Figure 1.1 (Power Derating Based on Temperature) of the Inverter Module User Manual (UMI1201000).

If NEC calculations for field-wiring at 65 °C indicate that a larger wire gauge should be used vs. the 40 °C wire gauge, then the calculated 65 °C gauge should be used. However, the power derating of the inverter modules should outpace any increase in gauge due to NEC wire derating.

**Table 5**  
Spec. No. 584130100 Lists 01, 01E, 02, 02E, 03, 03E, 04, 04E, 06, 06E, 07, and 08  
Inverter System Recommended AC Input Branch Circuit Protection and Wire Size

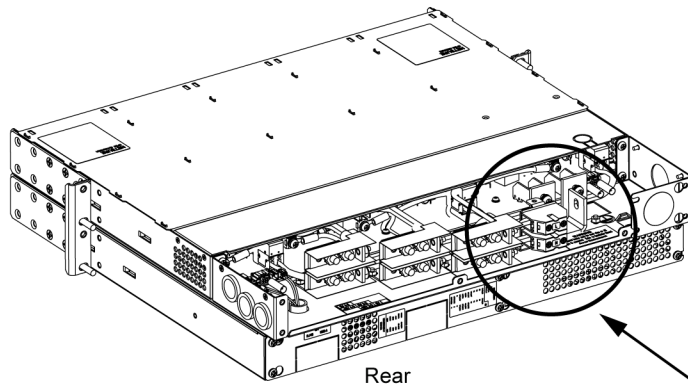

584130100 List 01 Shown.  
Other Configurations Similar.

Rear Panel(s) Removed in Illustrations

- 584130100 List 01
- 584130100 List 02
- 584130100 List 07

Wire Size Capacity: 20 AWG to 4 AWG.  
Recommended Torque: 26 in-lbs.

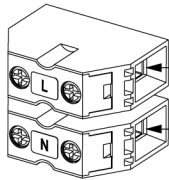

Line  
Neutral

AC Input Feed  
Terminal Block  
120 VAC, 50 / 60 HZ,  
Single Phase

- 584130100 List 01E
- 584130100 List 02E
- 584130100 List 03
- 584130100 List 03E
- 584130100 List 04
- 584130100 List 08

Wire Size Capacity: 14 AWG to 2/0 AWG.  
Recommended Torque:  
35 lbf.in (3.95 N.m) 12 AWG  
35 lbf.in (3.95 N.m) 14 AWG  
40 lbf.in (4.52 N.m) 8 AWG  
120 lbf.in (13.56 N.m) 6 AWG to 2/0 AWG

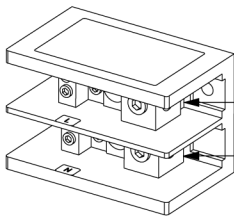

Line  
Neutral

AC Input Feed  
Terminal Block  
120 VAC, 50 / 60 HZ,  
Single Phase

- 584130100 List 04E
- 584130100 List 06
- 584130100 List 06E

Wire Size Capacity: 14 AWG to 2/0 AWG.  
Recommended Torque:  
35 lbf.in (3.95 N.m) 14 AWG to 10 AWG  
40 lbf.in (4.52 N.m) 8 AWG  
120 lbf.in (13.56 N.m) 6 AWG to 2/0 AWG

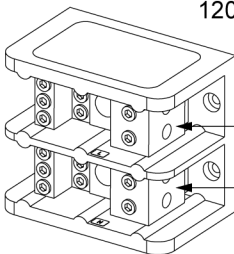

Line  
Neutral

AC Input Feed  
Terminal Block  
120 VAC, 50 / 60 HZ,  
Single Phase

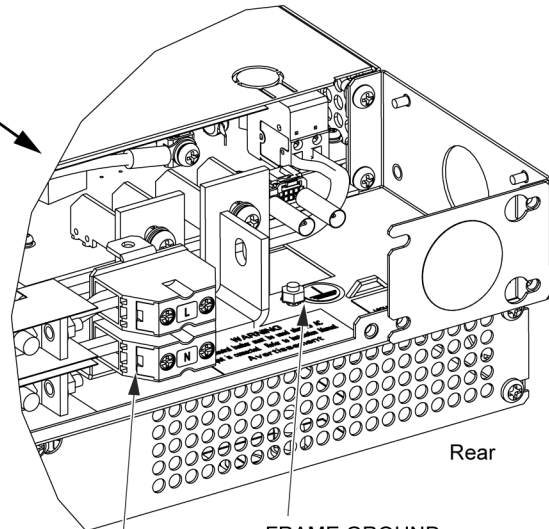

AC Input Feed  
Terminal Block  
120 VAC, 50 / 60 HZ,  
Single Phase

**FRAME GROUND**  
One M4 x 7mm  
Stud and Hardware.  
Recommended torque:  
20 in-lbs.

Figure 2  
AC Input Connections

**DC Input Connections (Spec. No. 584130100 Lists 01, 01E, 02, 02E, 03, 03E, 04, 04E, 05, 05E, 06, 06E, 07, and 08)**

**DC Input Branch Circuit Protection and Wire Size Selection**

Refer to Table 6 for recommended wire sizes and branch circuit protection. Refer to Figure 3 for an illustration.

**Note:** If the input to the inverter system is provided from a DC input source only, an AC neutral reference must be provided by bonding the "Neutral" output of the inverter system to the frame of the inverter system with the furnished bonding busbar. Refer to IM584130100 for a procedure.

Spec. No. 584130100 Lists 01, 01E, 02, 02E, 03, 03E, 04, 04E, 05, 05E, 06, 06E, 07, and 08 Inverter System Recommended DC Input Branch Circuit Protection and Wire Size Provides Input Terminations for "One DC Feed per Two Inverters" (Nominal 48 VDC)							
List Number	Input Voltage	Input Current per DC Feed	Overcurrent Protection <sup>(1)</sup>	40 °C Ambient Temperature		65 °C Ambient Temperature	
				Wire <sup>(2) (3)</sup>	Conduit Size (in)	Wire <sup>(2) (3)</sup>	Conduit Size (in)
List 01, 02, 07	48 - 54 VDC	46 – 40 A	60 A	8 AWG	1/2 (x3) <sup>(4)</sup>	8 AWG	1/2 (x3) <sup>(4)</sup>
List 01E, 02E, 03, 04, 08	48 - 54 VDC	46 – 40 A	60 A	6 AWG	1 (x2) <sup>(5)</sup>	6 AWG	1 (x2) <sup>(5)</sup>
List 03E, 04E, 05, 06	48 - 54 VDC	46 – 40 A	60 A	6 AWG	1 (x3) <sup>(6)</sup>	6 AWG	1 (x3) <sup>(6)</sup>
List 05E, 06E	48 - 54 VDC	46 – 40 A	60 A	6 AWG	1 (x4) <sup>(7)</sup>	6 AWG	1 (x4) <sup>(7)</sup>

- <sup>1</sup> The DC input branch circuit protective device should be of the time-delay or high inrush type.
- <sup>2</sup> Wire sizes based on recommendations of the American National Standards Institute (ANSI) approved National Fire Protection Association's (NFPA) National Electrical Code (NEC). Table 310.15 (B) (16) for copper wire at 90 °C conductor temperature. For operation in countries where the NEC is not recognized, follow applicable codes.
- <sup>3</sup> THHN 90°C Wire.
- <sup>4</sup> Six (6) inverter modules (DC Input: 2 current and 1 ground wire) per three (3) DC conduits per system.
- <sup>5</sup> Twelve (12) inverter modules (DC Input: 6 current and 1 ground wire) per two (2) DC conduits per system.
- <sup>6</sup> Eighteen (18) inverter modules (DC Input: 6 current and 1 ground wire) per three (3) DC conduits per system.
- <sup>7</sup> Twenty-Four (24) inverter modules (DC Input: 6 current and 1 ground wire) per four (4) DC conduits per system.
- <sup>8</sup> If the input to the inverter system is provided from a DC input source only, an AC neutral reference must be provided by bonding the "Neutral" output of the inverter system to the frame of the inverter system with the furnished bonding busbar. Refer to IM584130100 for a procedure.

Table 6  
Spec. No. 584130100 Lists 01, 01E, 02, 02E, 03, 03E, 04, 04E, 05, 05E, 06, 06E, 07, and 08  
Inverter System Recommended DC Input Branch Circuit Protection and Wire Size

# Vertiv™ NetSure™ Inverter System

## System Application Guide

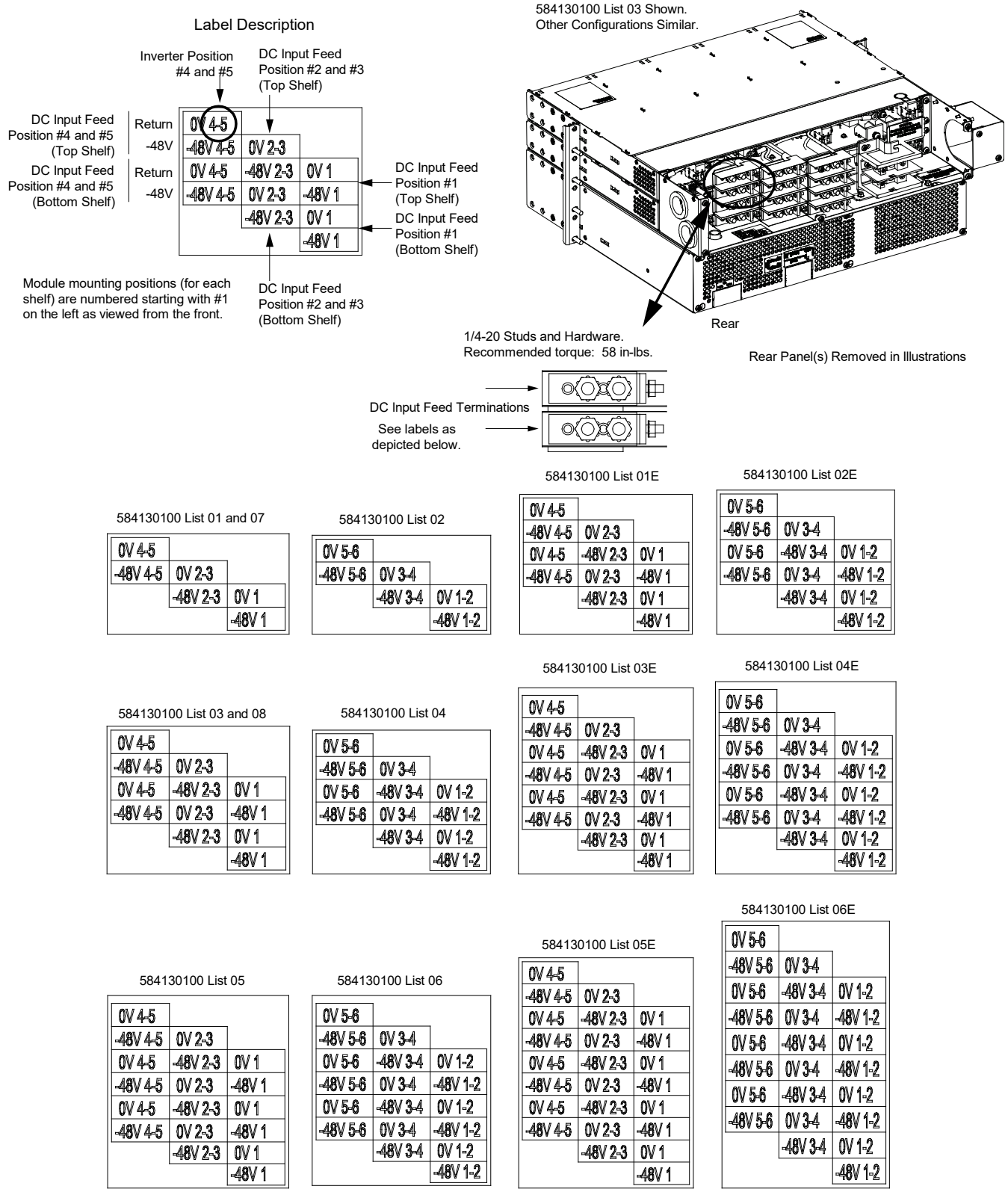
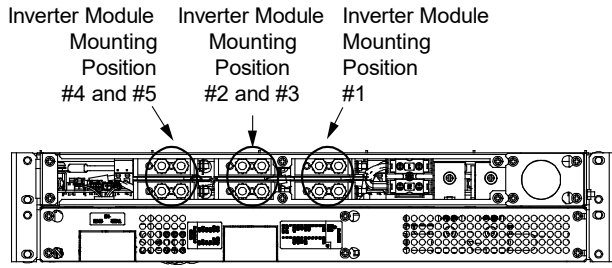
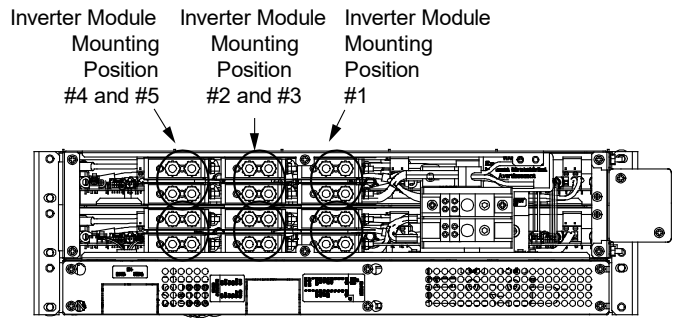

Figure 3 (cont'd on next page)  
DC Input Connections

Vertiv™ NetSure™ Inverter System  
System Application Guide



Rear 584130100 List 01 and 07



Rear 584130100 List 01E

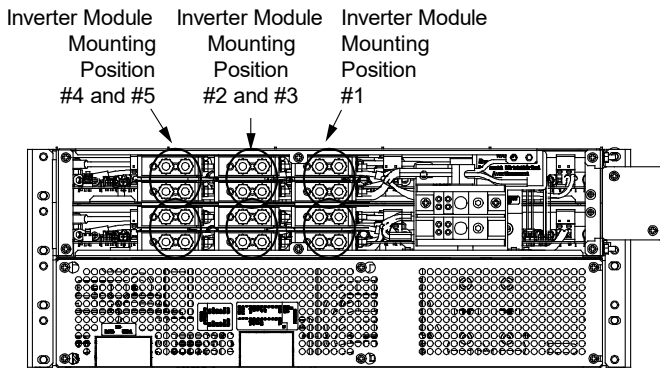

Rear 584130100 List 03 and 08

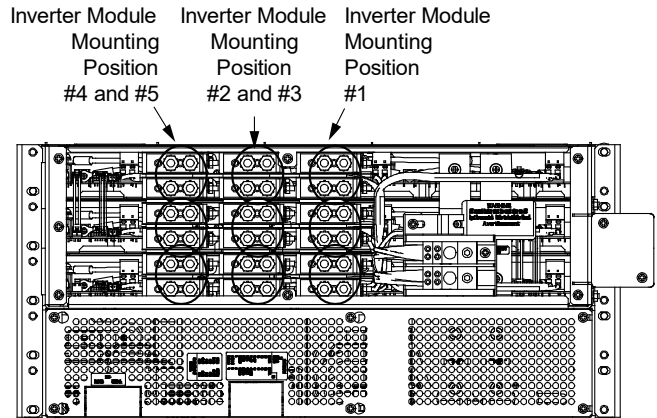

Rear 584130100 List 03E

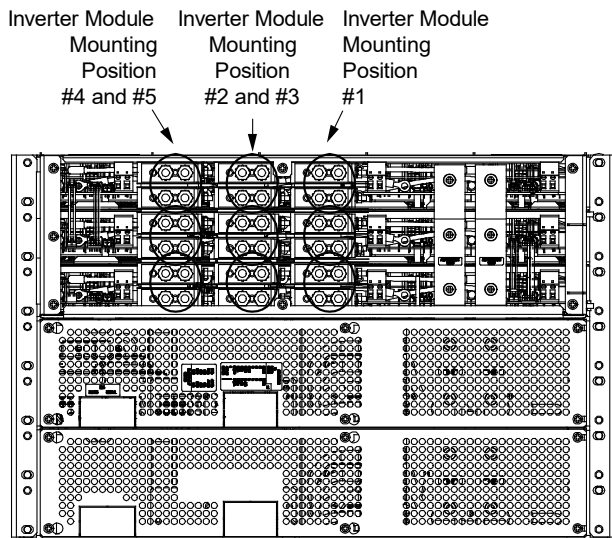

Rear 584130100 List 05

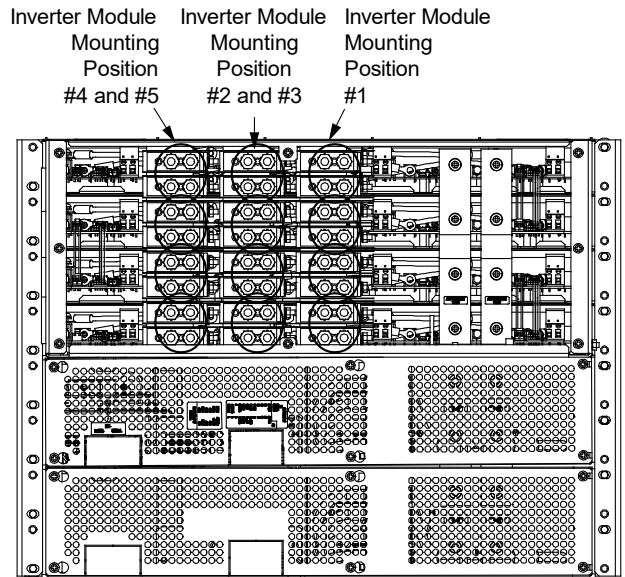

Rear 584130100 List 05E

Figure 3 (cont'd from previous page, cont'd from previous page)  
DC Input Connections



# Vertiv™ NetSure™ Inverter System

## System Application Guide

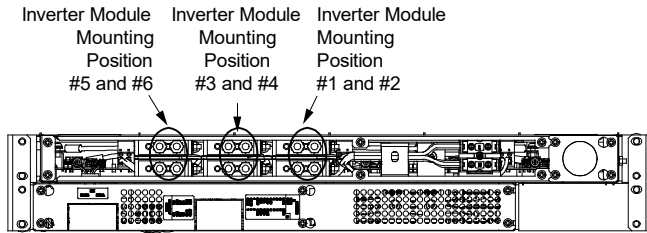

Rear 584130100 List 02

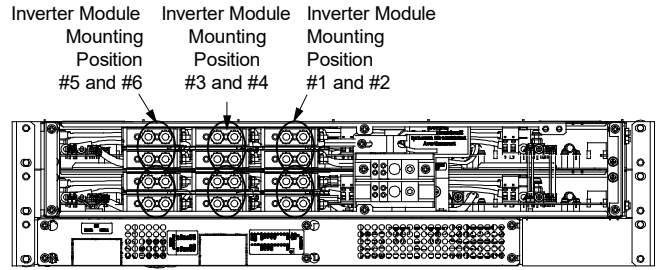

Rear 584130100 List 02E

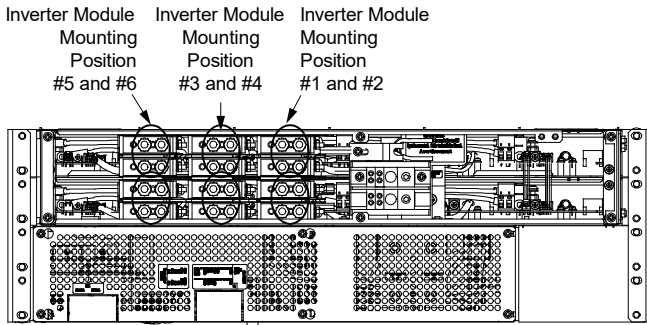

Rear 584130100 List 04

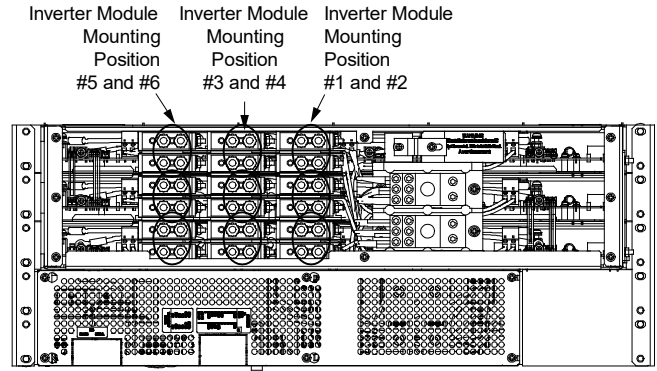

Rear 584130100 List 04E

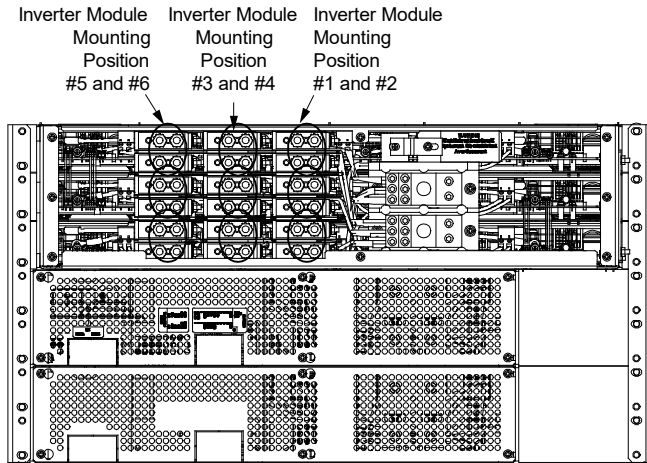

Rear 584130100 List 06

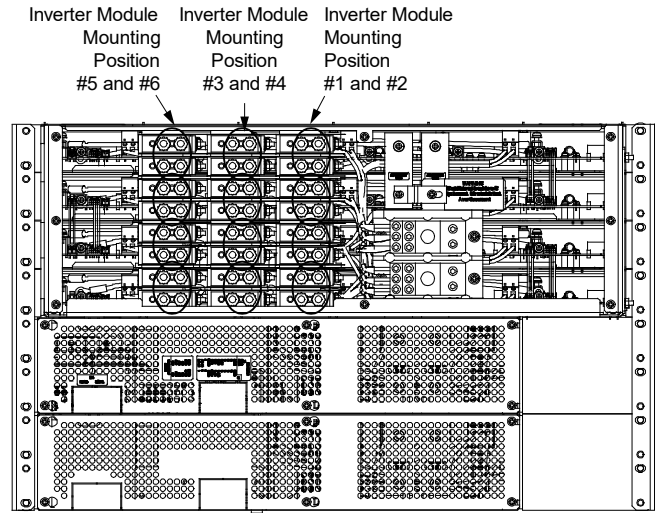

Rear 584130100 List 06E

Figure 3 (cont'd from previous page)  
DC Input Connections

**AC Output Connections (Spec. No. 584130100 List 01, 01E, 03, 03E, 05, and 05E)**

**AC Output Branch Circuit Protection and Wire Size Selection**

Refer to Table 7 and Table 8 for recommended wire sizes and branch circuit protection. Refer to Figure 4 for an illustration. Each 120 VAC output is protected by a 70 A circuit breaker located on the front of the unit.

Spec. No. 584130100 List 01 and 01E Inverter System Recommended AC Output Branch Circuit Protection and Wire Size 1RU AC Termination Panel with One (1) 70 A Overcurrent Protection Device (Nominal 120 VAC, Single Phase, 50 Hz / 60 Hz)						
Output Voltage	Output Current	Overcurrent Protection	40 °C Ambient Temperature		65 °C Ambient Temperature	
			Wire <sup>(3) (4)</sup>	Conduit Size (in) <sup>(5)</sup>	Wire <sup>(3) (4)</sup>	Conduit Size (in) <sup>(5)</sup>
120 VAC	50 A Note 1	70 A	6 AWG	3/4	4 AWG	1 Note 2

- <sup>1</sup> Output current determined as 50 A max (50 A X 120 VAC = 6 kVA rating) for the AC distribution panel.
- <sup>2</sup> The equipment grounding conductor can be 8 AWG minimum. If the installation uses two (2) 4 AWG cables and an 8 AWG ground cable, then 3/4-inch conduit is permissible. If the equipment grounding conductor is equivalent in size to the 4 AWG current carrying cables, then a 1-inch conduit is required and cannot be accommodated on the 1RU AC distribution panel.
- <sup>3</sup> Wire sizes based on recommendations of the American National Standards Institute (ANSI) approved National Fire Protection Association’s (NFPA) National Electrical Code (NEC). Table 310.15 (B) (16) for copper wire at 90 °C conductor temperature. For operation in countries where the NEC is not recognized, follow applicable codes.
- <sup>4</sup> THHN 90°C Wire.
- <sup>5</sup> Two current and one ground wire per conduit (one AC output conduit).

Table 7  
Spec. No. 584130100 List 01 and 01E  
Inverter System Recommended AC Output Branch Circuit Protection and Wire Size

Spec. No. 584130100 List 03, 03E, 05 and 05E Inverter System Recommended AC Output Branch Circuit Protection and Wire Size 2RU AC Termination Panel with Two (2) 70 A Overcurrent Protection Devices (Nominal 120 VAC, Single Phase, 50 Hz / 60 Hz)						
Output Voltage	Output Current	Overcurrent Protection	40 °C Ambient Temperature		65 °C Ambient Temperature	
			Wire <sup>(3) (4)</sup>	Conduit Size (in) <sup>(5)</sup>	Wire <sup>(3) (4)</sup>	Conduit Size (in) <sup>(5)</sup>
120 VAC	56 A Note 1	70 A	4 AWG	1 Note 2	4 AWG	1 Note 2

- <sup>1</sup> Output current determined as 80% of the 70 A breaker that is being used in the AC distribution panel.
- <sup>2</sup> The equipment grounding conductor can be 8 AWG minimum. If the installation uses two (2) 4 AWG cables and an 8 AWG ground cable, then 3/4-inch conduit is permissible. If the equipment grounding conductor is equivalent in size to the 4 AWG current carrying cables, then a 1-inch conduit is required.
- <sup>3</sup> Wire sizes based on recommendations of the American National Standards Institute (ANSI) approved National Fire Protection Association's (NFPA) National Electrical Code (NEC). Table 310.15 (B) (16) for copper wire at 90 °C conductor temperature. For operation in countries where the NEC is not recognized, follow applicable codes.
- <sup>4</sup> THHN 90°C Wire.
- <sup>5</sup> Two current and one ground wire per conduit (two AC output conduits).

Table 8  
Spec. No. 584130100 List 03, 03E, 05 and 05E  
Inverter System Recommended AC Output Branch Circuit Protection and Wire Size

# Vertiv™ NetSure™ Inverter System

## System Application Guide

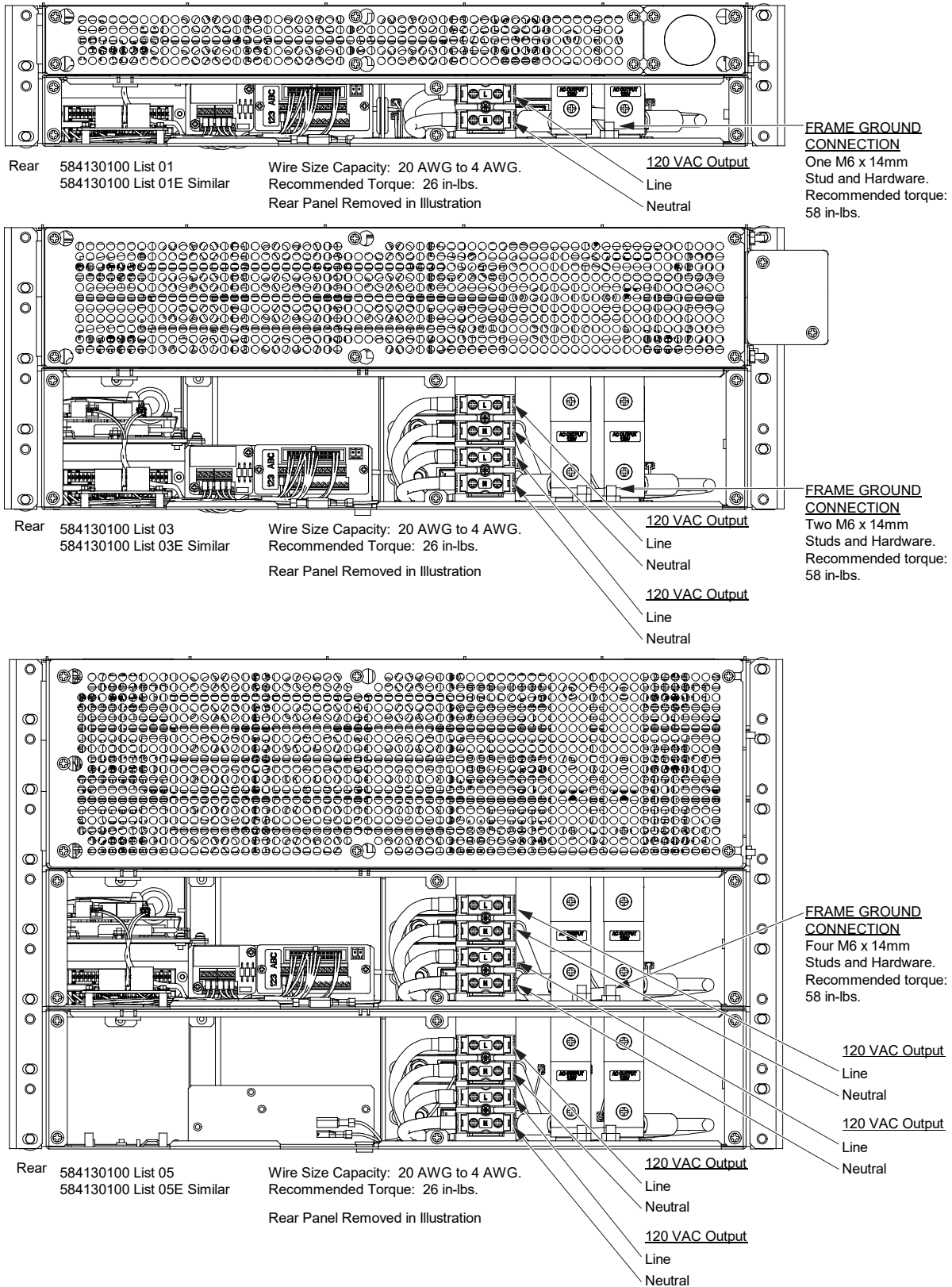
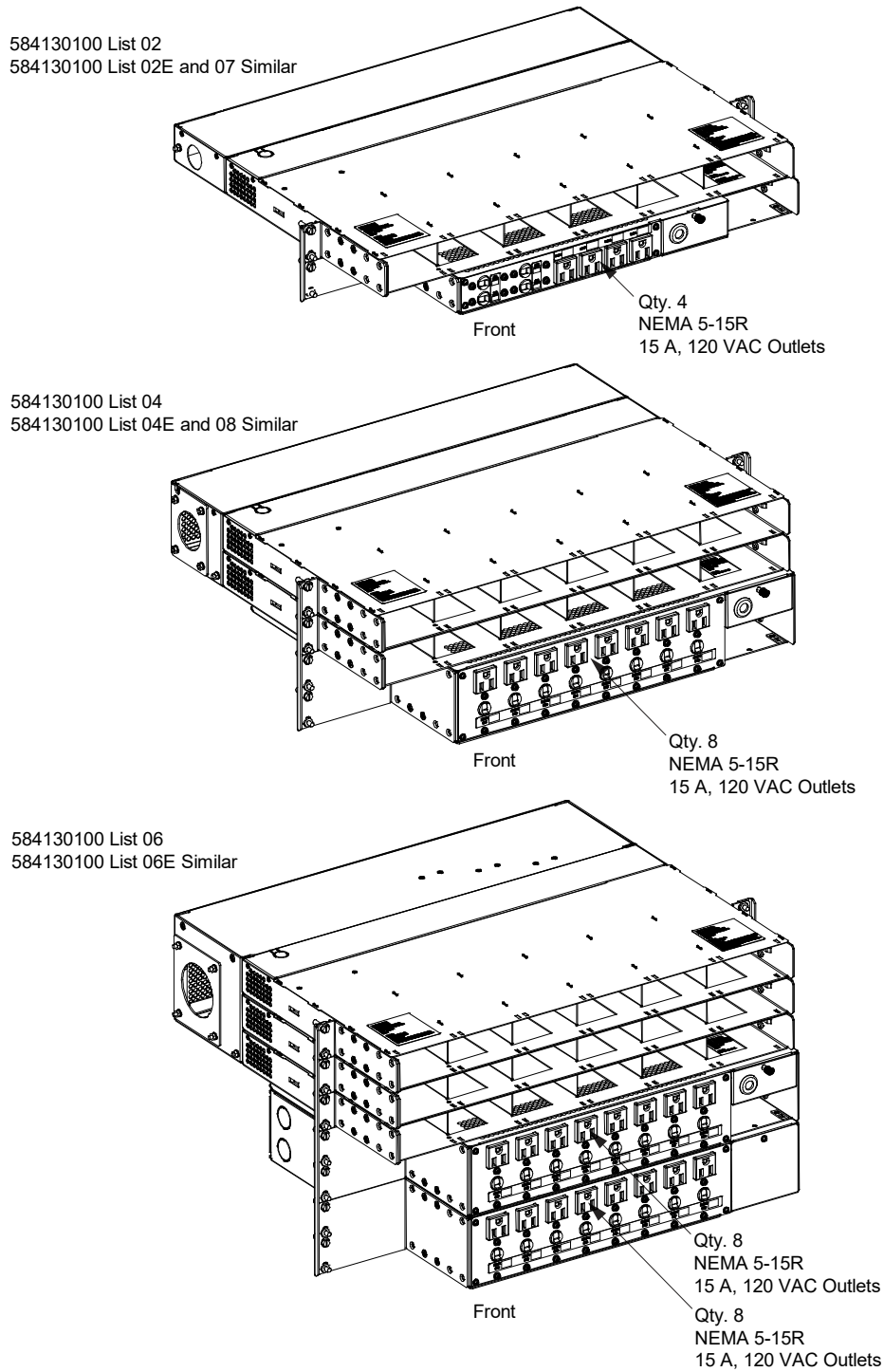

Figure 4  
AC Output Connections (List 01, 01E, 03, 03E, 05 and 05E)

**AC Output Connections (Spec. No. 584130100 List 02, 02E, 04, 04E, 06, 06E, 07, and 08)**

The 1RU and 2RU AC distribution panels with 15A NEMA / IEC connectors are automatically factory wired via the line cords that connect to the NEMA / IEC outlets. Refer to Figure 5 for an illustration of the NEMA panel.



### External Alarm, Reference, Monitoring, and Control Connections

#### General

Recommended wire size is 22 AWG for loop lengths up to 200 ft. and 18 AWG to 20 AWG for loop lengths over 200 ft.

#### External Alarm, Reference, Monitoring, and Control Connections Locations

Refer to Figure 6.

584130100 List 01 Shown.  
Other Configurations Similar.

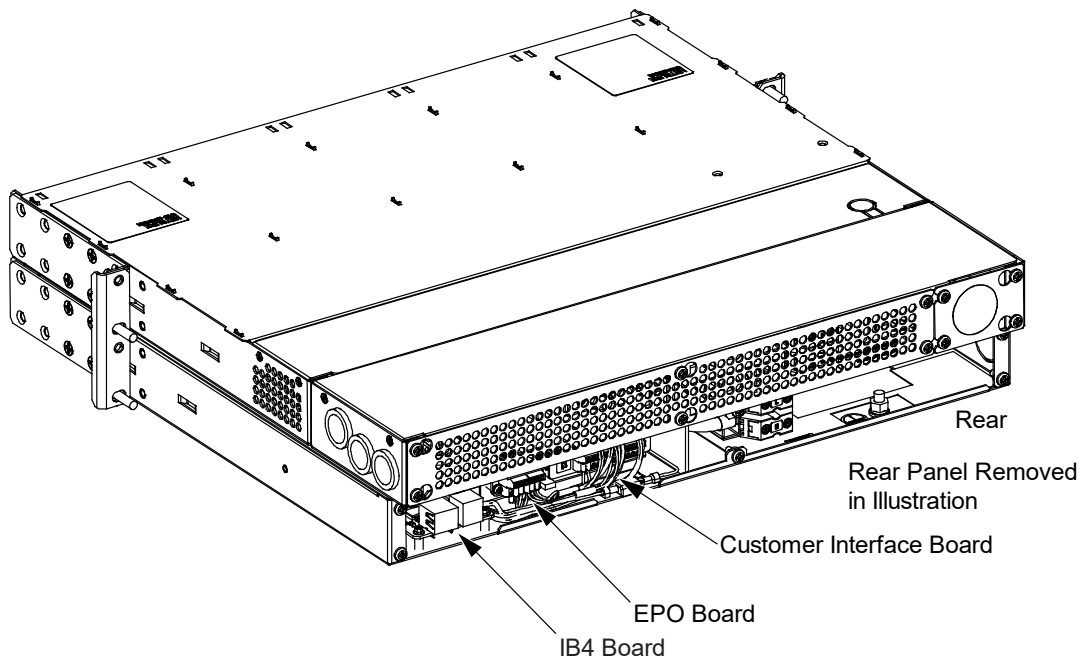
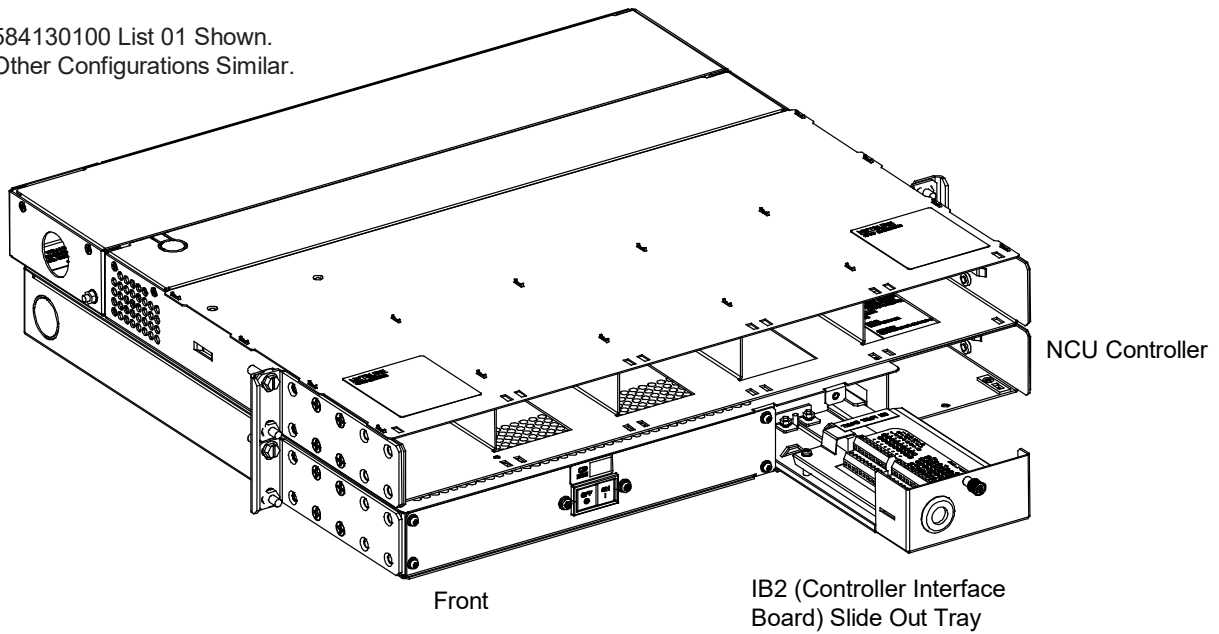

Figure 6  
External Alarm, Reference, Monitoring, and Control Connections Locations

**IB2 (Controller Interface Board)**

Refer to Figure 7.

The relay assigned to “Critical Summary” alarm (relay 1 by default) will operate in the “Fail Safe Mode”. “Fail Safe Mode” means Relay 1 is de-energized during an alarm condition, opening the contacts between the C and NO terminals, and closing the contacts between the C and NC terminals. The remaining seven (7) relays energize during an alarm condition, closing the contacts between the C and NO terminals, and opening the contacts between the C and NC terminals.

Not all I/O points may be available for customer connection (some may be used for factory system connections). The digital inputs and relay outputs may be preprogrammed for specific functions. Refer to the configuration drawing (C-drawing) supplied with your system for your system’s specific configuration.

**J3-J9:**

Wire Size Capacity: 16 AWG to 26 AWG.  
Wire Strip Length: 0.20 inch.  
Recommended Torque: 2.2 in-lbs.

IB2 Assembly (with shield)

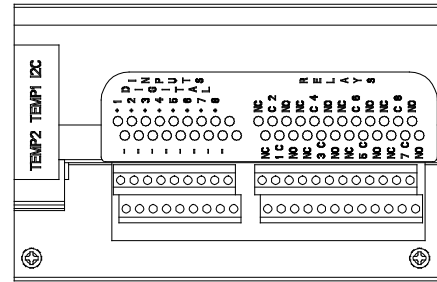

Switch settings must be in this position to interface with the controller.

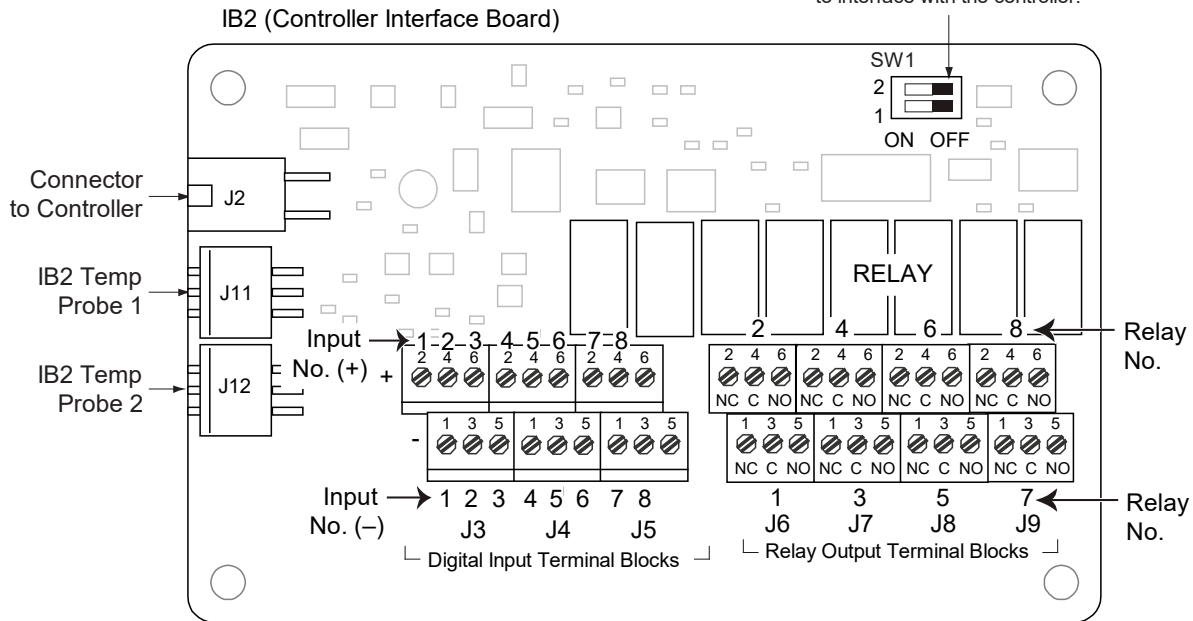

Schematic Diagram of IB2 (Controller Interface Board)

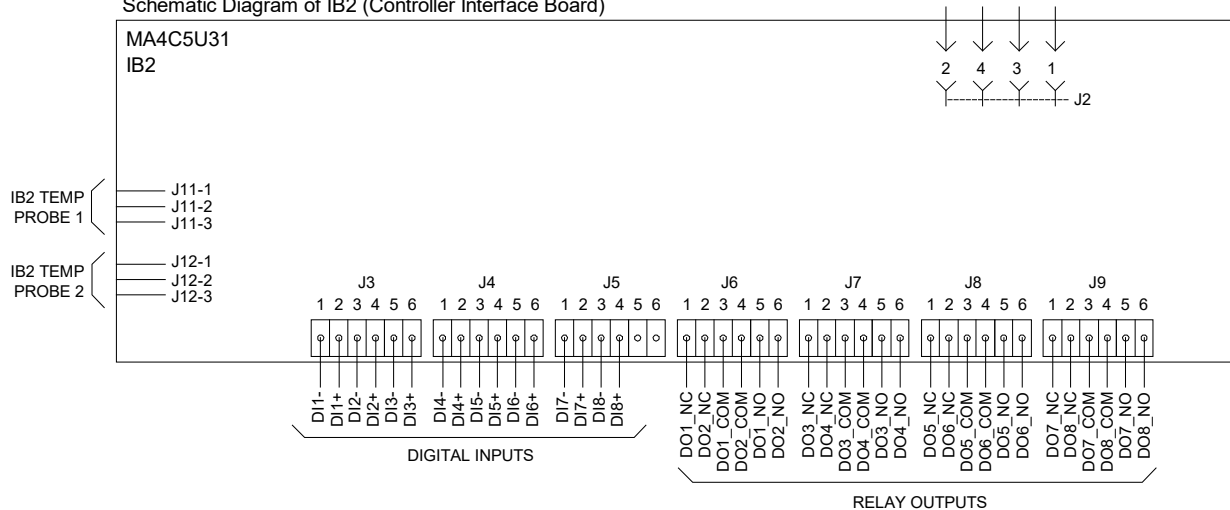
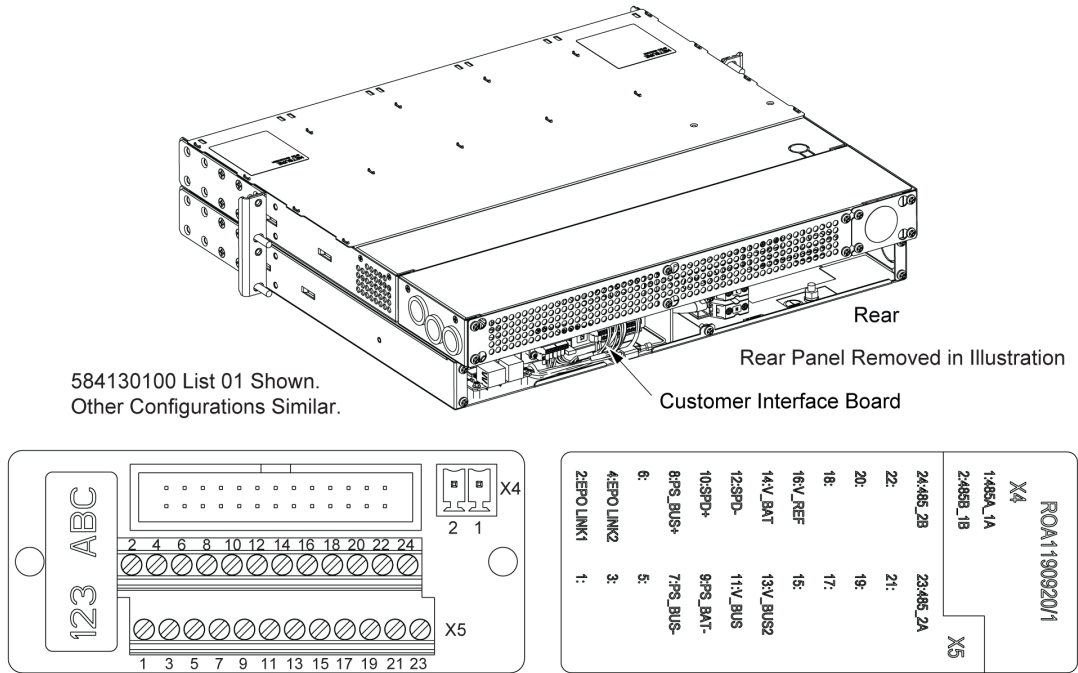

Figure 7  
IB2 (Controller Interface Board)

**Customer Interface Board – MANDATORY WIRING FOR SYSTEM OPERATION!!**

Refer to Figure 8.



**REQUIRED CONNECTIONS**

The following connections from the Customer Interface Board to the locations outlined below are **REQUIRED** for the inverter system to operate properly. Connect the loose ends of the pre-terminated wires to the appropriate points in the power system described below.

**NCU Power Connections:**

- From PS\_BUS- (X5 pin 7) to system negative busbar - 1A fuse or breaker
- From PS\_BUS+ (X5 pin 8) to system positive busbar

**OPTIONAL CONNECTIONS**

The following are optional connections to the Customer Interface Board:

**Southbound MODBUS**

- Connections:
- RS485+\_1 (X4 pin 1)
  - RS485-\_1 (X4 pin 2)

**Northbound MODBUS**

- Connections:
- RS485+\_2 (X5 pin 23)
  - RS485-\_2 (X5 pin 24)

**Digital Input for Surge Protection Device**

- Connections:
- SPD+ (X5 pin 10)
  - SPD- (X5 pin 12)

**Notes:**

- Relay switch state detection - NC dry contact

**Emergency Power Off Connections:**

- EPO\_LINK 1 (X5 pin 2) factory connected to EPO\_LINK 2 (X5 pin 4)

**Notes:**

- Link closed = normal operation
- Link open = EPO activated
- Customer can replace the EPO link with a normally closed emergency switch on site

Figure 8  
Customer Interface Board – Mandatory Wiring for System Operation



### NCU Controller Ethernet Connection (if required)

The controller provides a Web Interface via an Ethernet connection to a TCP/IP network. This interface can be accessed locally on a computer and/or remotely through a network. The system has two Ethernet ports. One located on the NCU front panel and the other located on the IB4 board. The function of these Ethernet ports are as follows.

#### NCU Front Panel Ethernet Port

An RJ-45 10BaseT jack is provided on the front of the controller for connecting a computer directly to the NCU. This jack has a standard Ethernet pin configuration scheme, twisted pair. Refer to Figure 9 for location. Refer to the NCU Instructions (UM1M830BNA) for operational details.

**Note:** DO NOT connect your Local Area Network (LAN) to the NCU front Ethernet port.

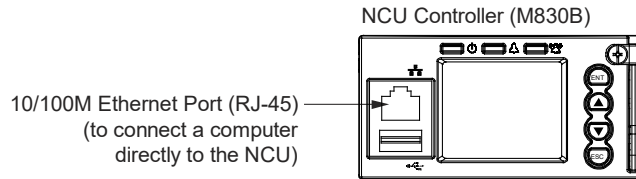

Figure 9  
NCU Ethernet Port  
(for connecting a computer directly to the NCU)

#### IB4 Board Ethernet Port

An RJ-45 10BaseT jack is provided on the IB4 board for connection into a customer's network. Use this Ethernet port to connect the NCU to your Local Area Network (LAN). This jack has a standard Ethernet pin configuration scheme, twisted pair. Refer to Figure 10 for IB4 board and Ethernet port location. Use shielded Ethernet cable (grounded at both ends). Note that the IB4 board's RJ-45 jack is connected to chassis ground. Refer to the NCU Instructions (UM1M830BNA) for operational details.

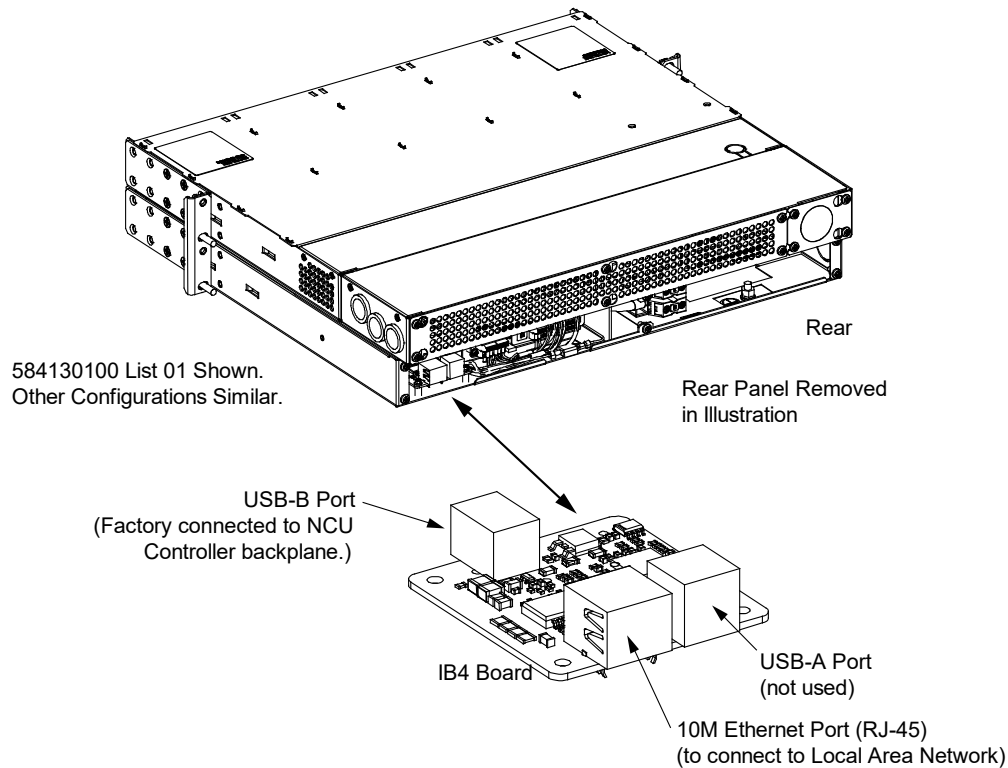

Figure 10  
IB4 Board Ethernet Port  
(for connection into a customer's network)

## SPECIFICATIONS

### 1. SYSTEM

- 1.1 AC Input and DC Input Ratings (see also “General Inverter Systems Specifications” starting on page 3.)
  - 1.1.1 Operating Voltage Range: 42 VDC to 58 VDC, 96 VAC to 140 VAC.
  - 1.1.2 Frequency Range: 50 Hz (47 Hz to 53 Hz) or 60 Hz (57 Hz to 63 Hz).
  - 1.1.3 Stopping Voltages: Refer to 1.1.1.
  - 1.1.4 Restart Voltages: After low voltage shutdown 48 VDC / 101 VAC; After high voltage shutdown 57 VDC / 135 VAC.
  - 1.1.5 Nominal Input Current (per inverter @ 100% load): 23 A @ -48 VDC, 8.8 A @ 120 VAC.
  - 1.1.6 Maximum Input Current (per inverter @ 100% load): 26.4 A @ -42 VDC, 11 A @ 96 VAC.
- 1.2 AC Output Ratings (see also “General Inverter Systems Specifications” starting on page 3.)
  - 1.2.1 Nominal Output Voltage: 120 VAC.
  - 1.2.2 Output Voltage Tolerance: Fixed 120 VAC.
  - 1.2.3 Output Frequency: 50 Hz or 60 Hz.
  - 1.2.4 Total Harmonic Distortion (linear load): < 3% @ 100% linear load for inverter.
  - 1.2.5 Nominal Output Power: 1000 W / 1000 VA per inverter.
  - 1.2.6 Overload: 110% to 125% @ 42 VDC to 48 VDC (15s), 125% @ 96 VAC to 140 VAC (15s).  
Maximum input current: 3 x In (nominal current) for 120ms.
  - 1.2.7 Power Factor: >0.99.
- 1.3 Environmental Ratings
  - 1.3.1 Operating Ambient Temperature Range: -20 °C to +65 °C (-4 °F to +149 °F).
  - 1.3.2 Storage Ambient Temperature Range: -40 °C to +70 °C (-40 °F to +158 °F).
  - 1.3.3 Relative Humidity: Capable of operating in an ambient relative humidity range of 0% to 90%, non-condensing.
  - 1.3.4 Altitude: Capable of operating in an altitude range of -200 feet to 10,000 feet. The maximum operating ambient temperature should be de-rated by 3 °C per 1000 feet above 6562 feet.
  - 1.3.5 Audible Noise:
    - (A) 50 dB per Telcordia GR-63.
    - (B) Inverter Requirements: 50 dB(A) at <25 degrees C measured at 60cm distance.
  - 1.3.6 Surge Protection:
    - (A) AC Input Power Port: Level 4 (4kV) (Line to Earth), Level 3 (2kV) (Line to Line) Based on B.
    - (B) AC Output Power Port: Level 4 (2kV) (Line to Earth), Level 3 (1kV) (Line to Line) Based on B.
    - (C) Signal and Control Ports (cables length exceed 30m): Level 2 (1kV) based on B.
  - 1.3.7 Ventilation Requirements: The system must be mounted so ventilating openings are not blocked and temperature of the air entering the system does not exceed the Operating Ambient Temperature Range stated above. Refer also to “Mounting” below.
  - 1.3.8 Mounting: This power system is designed to mount in a standard 19” or 23” relay rack or equipment rack having 1-3/4” multiple drillings. Refer to “Overall Dimensions” on page 44 for mounting dimensions.
    - This product is recommended to be installed in a restricted access location on or above a non-combustible surface.
    - This product is recommended to be located in a controlled environment with access to crafts persons only.
    - The system must be mounted in an environment that does not exceed the Operating Ambient Temperature Range stated above.
    - Clearance requirements are (relay rack or equipment rack):
      - a) Recommended minimum aisle space clearance for the front of each bay is 2'6" (for operation and maintenance).
      - b) Recommended minimum aisle space clearance for the rear of each bay is 2'0" (for installation and maintenance).
      - c) No space required above or below the unit (for ventilation only, installation and maintenance may require more clearance).

### 1.4 Compliance Information

#### 1.4.1 Safety Compliance:

- (A) UL 1778, 5th Ed, 2014-06-13 (Uninterruptible Power Systems).
- (B) CAN/CSA C22.2 NO. 107.3:14, 3rd Ed (Uninterruptible Power Systems).

### 1.5 IB2 (Controller Interface Board) Ratings

#### 1.5.1 Digital Input Ratings

- (A) Maximum Voltage Rating: 60 VDC.
- (B) Active High: > 19 VDC.
- (C) Active Low: < 1 VDC.

#### 1.5.2 Relay Ratings

- (A) Steady State: 0.5 A @ 60 VDC; 1.0 A @ 30 VDC.
- (B) Peak: 3 A @ 30 VDC.

### 1.6 Safety Standard IEC/EN62040-1-1

#### 1.6.1 Number of Inverters Required to Open a Circuit Breaker in the Event of a Short Circuit Condition:

- (A) AC Distribution Panels with 70 A Circuit Breaker: Four (4) inverters in a 25 °C or 40 °C ambient are required to open the 70 A circuit breaker in the event a short condition occurs downstream of the overcurrent device. Eight (8) inverters would be required in a 65 °C ambient.
- (B) AC Distribution Panels with 15 A Circuit Breaker: One (1) inverter in a 25 °C or 40 °C ambient is required to open the 15 A circuit breaker in the event a short condition occurs downstream of the overcurrent device. Two (2) inverters would be required in a 65 °C ambient.
- (C) The inverter system will turn off in five (5) seconds if a short condition occurs downstream of the overcurrent device and the overcurrent device has not opened.

## 2. INVERTER

Refer to the Inverter Instructions (UM111201000).

## 3. CONTROLLER

Refer to the NCU Controller Instructions (UM1M830BNA).

For controller factory settings, refer to the Controller Configuration Drawing (C-drawing).

**MECHANICAL SPECIFICATIONS**

**Overall Dimensions**

List 01 and 07 (List 01 Shown)

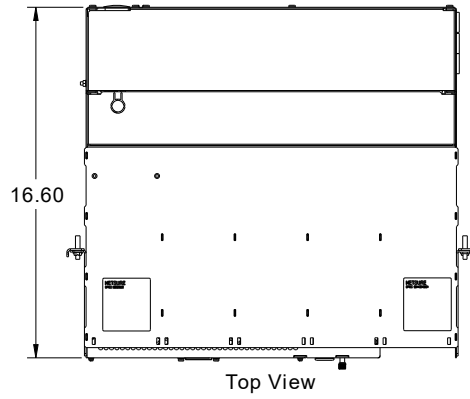

- Notes:
1. All dimensions are in inches unless otherwise specified.
  2. Finish:  
Faceplates: Textured Gray.  
Other Surfaces: Bright Zinc.

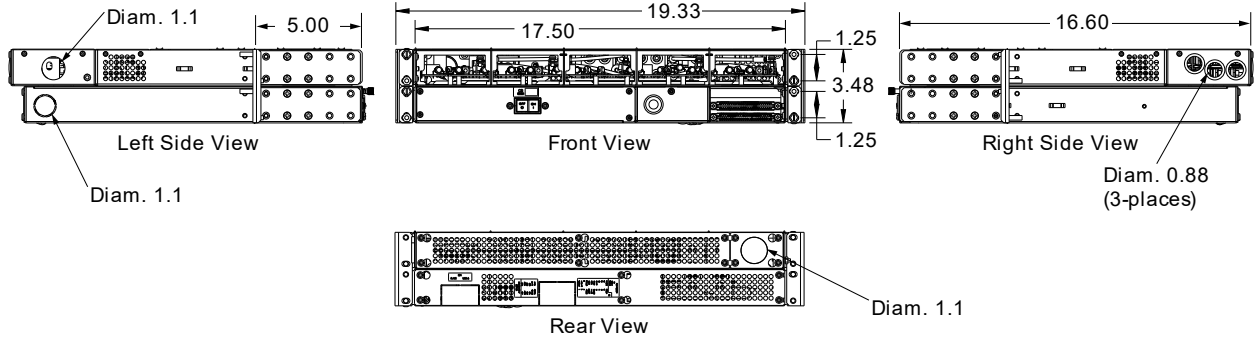

# Vertiv™ NetSure™ Inverter System

## System Application Guide

### List 01E

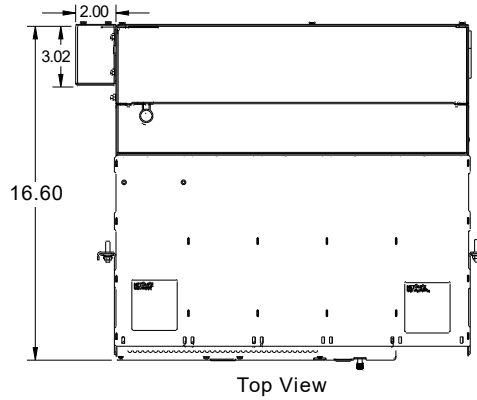

- Notes:
1. All dimensions are in inches unless otherwise specified.
  2. Finish:  
Faceplates: Textured Gray.  
Other Surfaces: Bright Zinc.

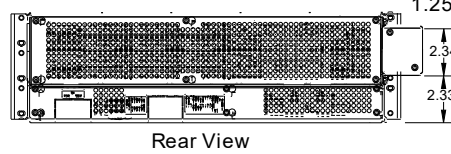
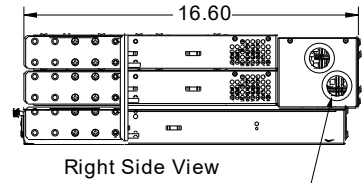
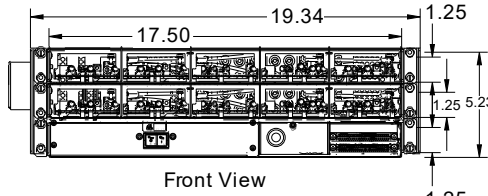
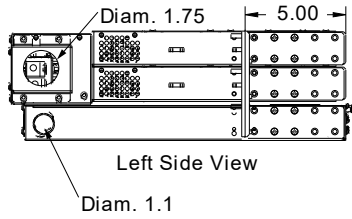

# Vertiv™ NetSure™ Inverter System

## System Application Guide

### List 02

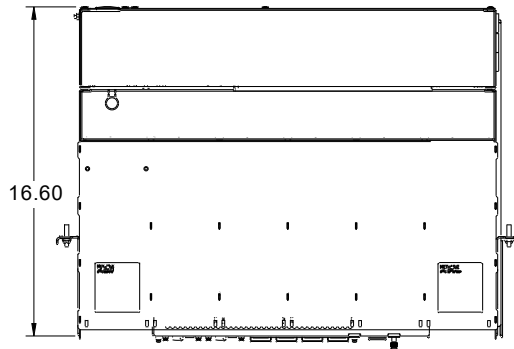

Top View

- Notes:
1. All dimensions are in inches unless otherwise specified.
  2. Finish:  
Faceplates: Textured Gray.  
Other Surfaces: Bright Zinc.

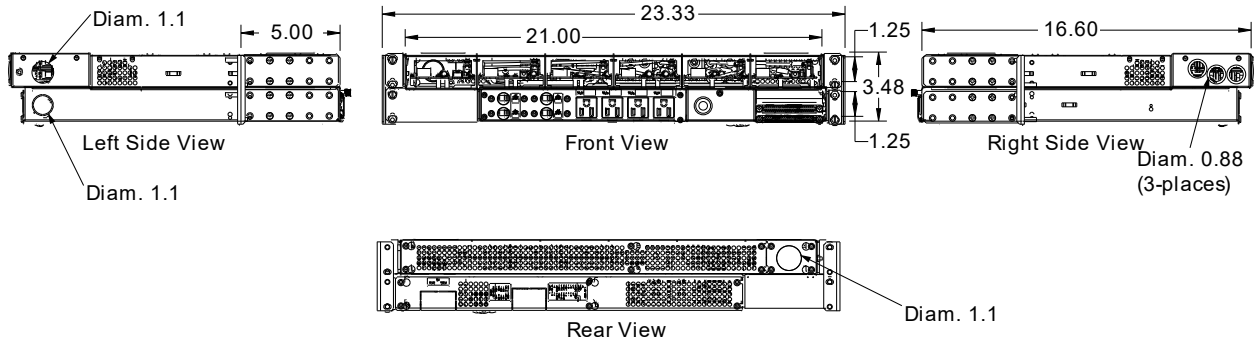

Vertiv™ NetSure™ Inverter System  
System Application Guide

List 02E

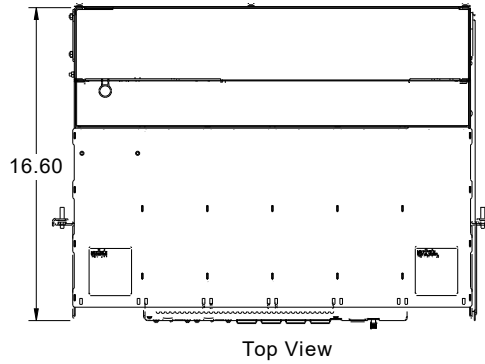

- Notes:
1. All dimensions are in inches unless otherwise specified.
  2. Finish:  
Faceplates: Textured Gray.  
Other Surfaces: Bright Zinc.

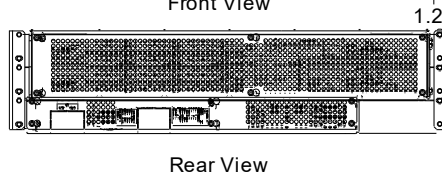
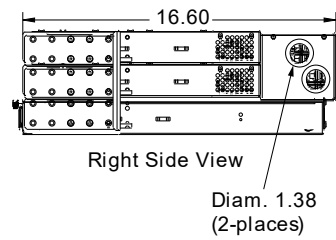
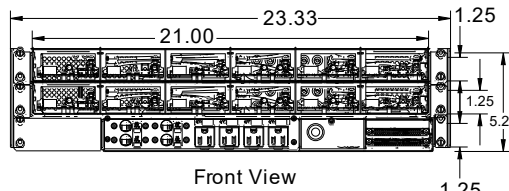
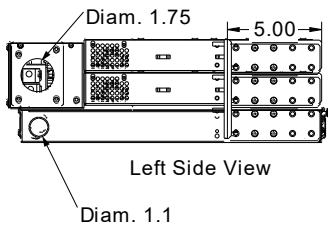

# Vertiv™ NetSure™ Inverter System

## System Application Guide

### List 03 and 08 (List 03 Shown)

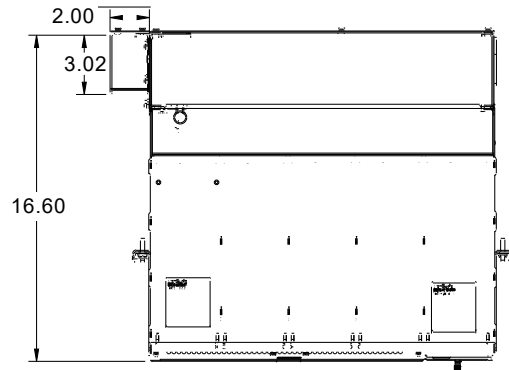

Top View

- Notes:
1. All dimensions are in inches unless otherwise specified.
  2. Finish:  
Faceplates: Textured Gray.  
Other Surfaces: Bright Zinc.

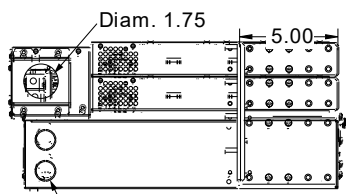

Left Side View

Diam. 1.1 (2-places)

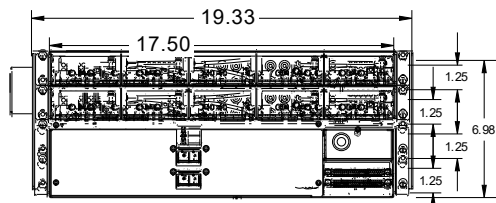

Front View

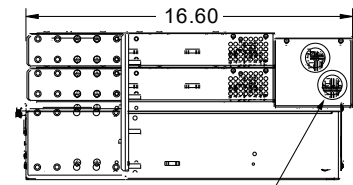

Right Side View  
Diam. 1.38  
(2-places)

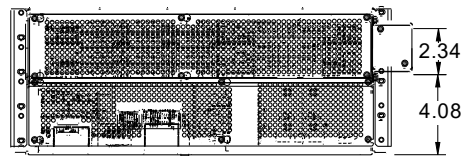

Rear View



# Vertiv™ NetSure™ Inverter System

## System Application Guide

### List 03E

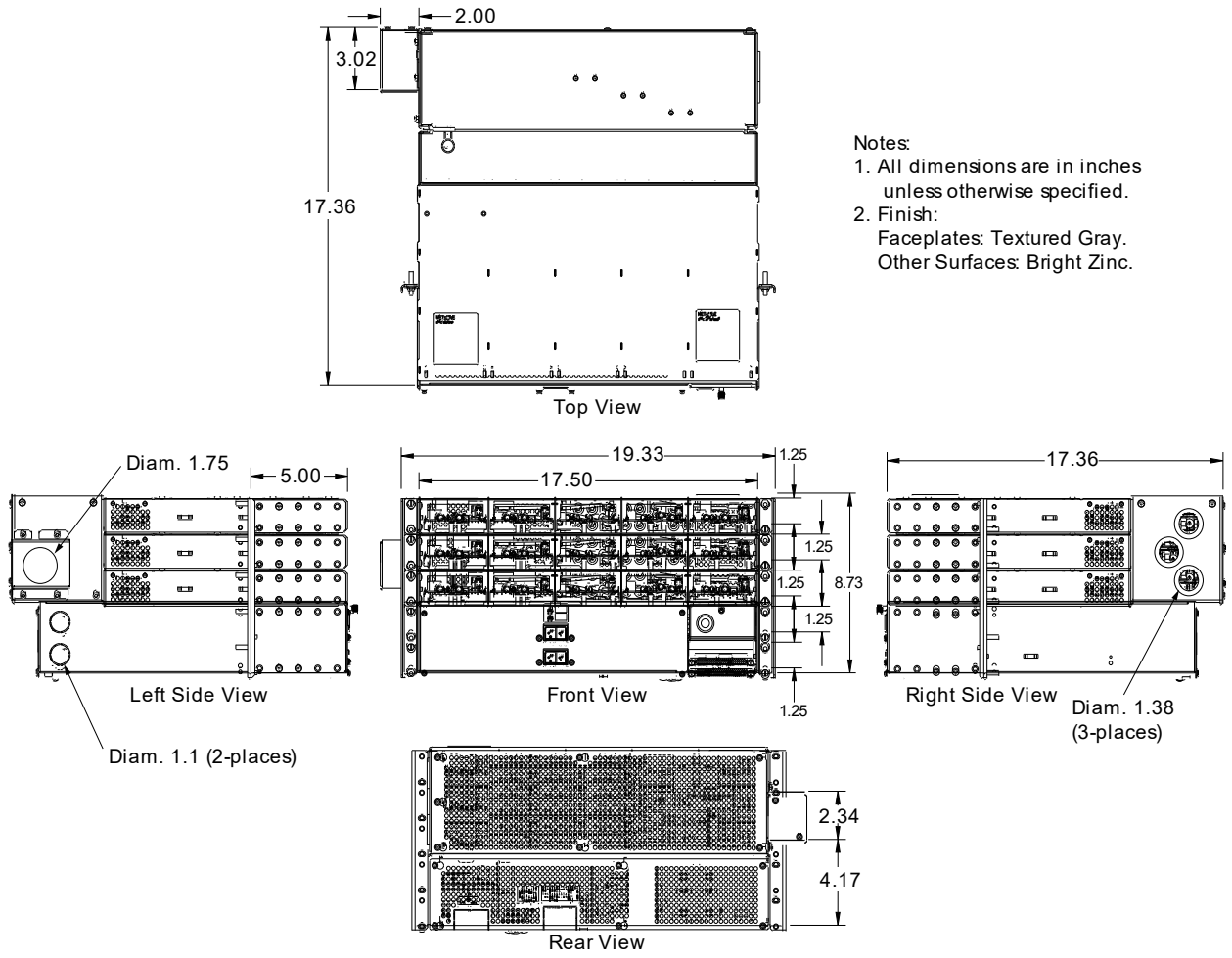

- Notes:
1. All dimensions are in inches unless otherwise specified.
  2. Finish:  
Faceplates: Textured Gray.  
Other Surfaces: Bright Zinc.

Vertiv™ NetSure™ Inverter System  
System Application Guide

List 04

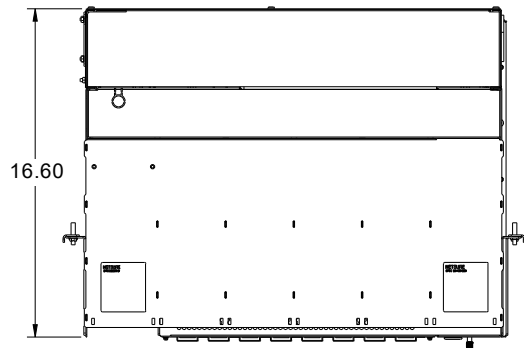

Top View

- Notes:
1. All dimensions are in inches unless otherwise specified.
  2. Finish:  
Faceplates: Textured Gray.  
Other Surfaces: Bright Zinc.

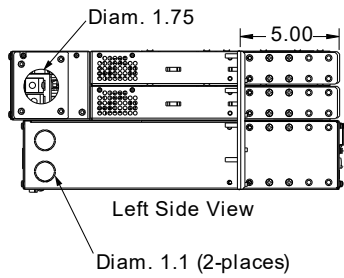

Left Side View

Diam. 1.1 (2-places)

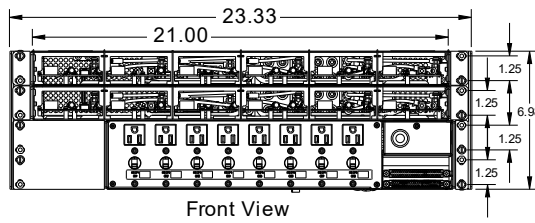

Front View

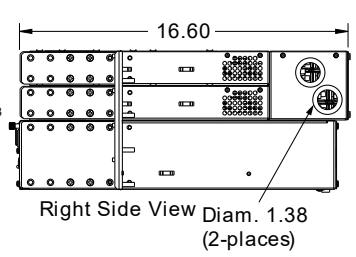

Right Side View

Diam. 1.38 (2-places)

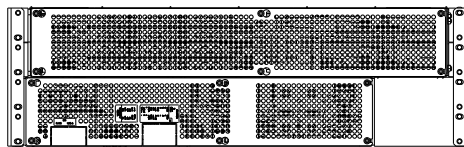

Rear View

# Vertiv™ NetSure™ Inverter System

## System Application Guide

### List 04E

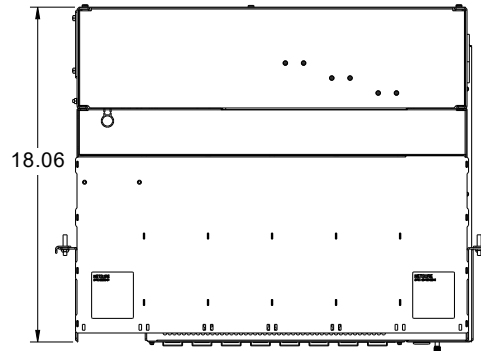

Top View

- Notes:
1. All dimensions are in inches unless otherwise specified.
  2. Finish:  
Faceplates: Textured Gray.  
Other Surfaces: Bright Zinc.

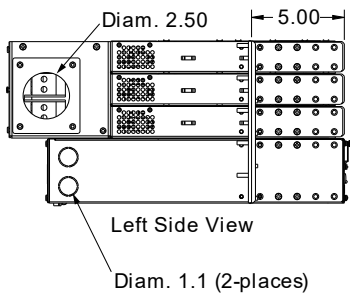

Left Side View

Diam. 1.1 (2-places)

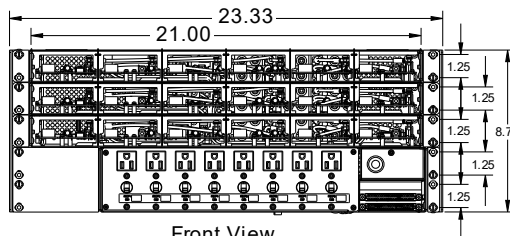

Front View

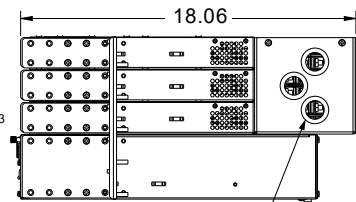

Right Side View

Diam. 1.38 (3-places)

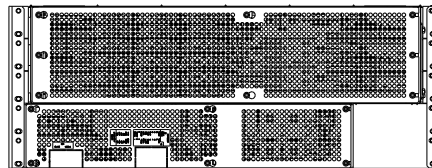

Rear View

Vertiv™ NetSure™ Inverter System  
System Application Guide

List 05

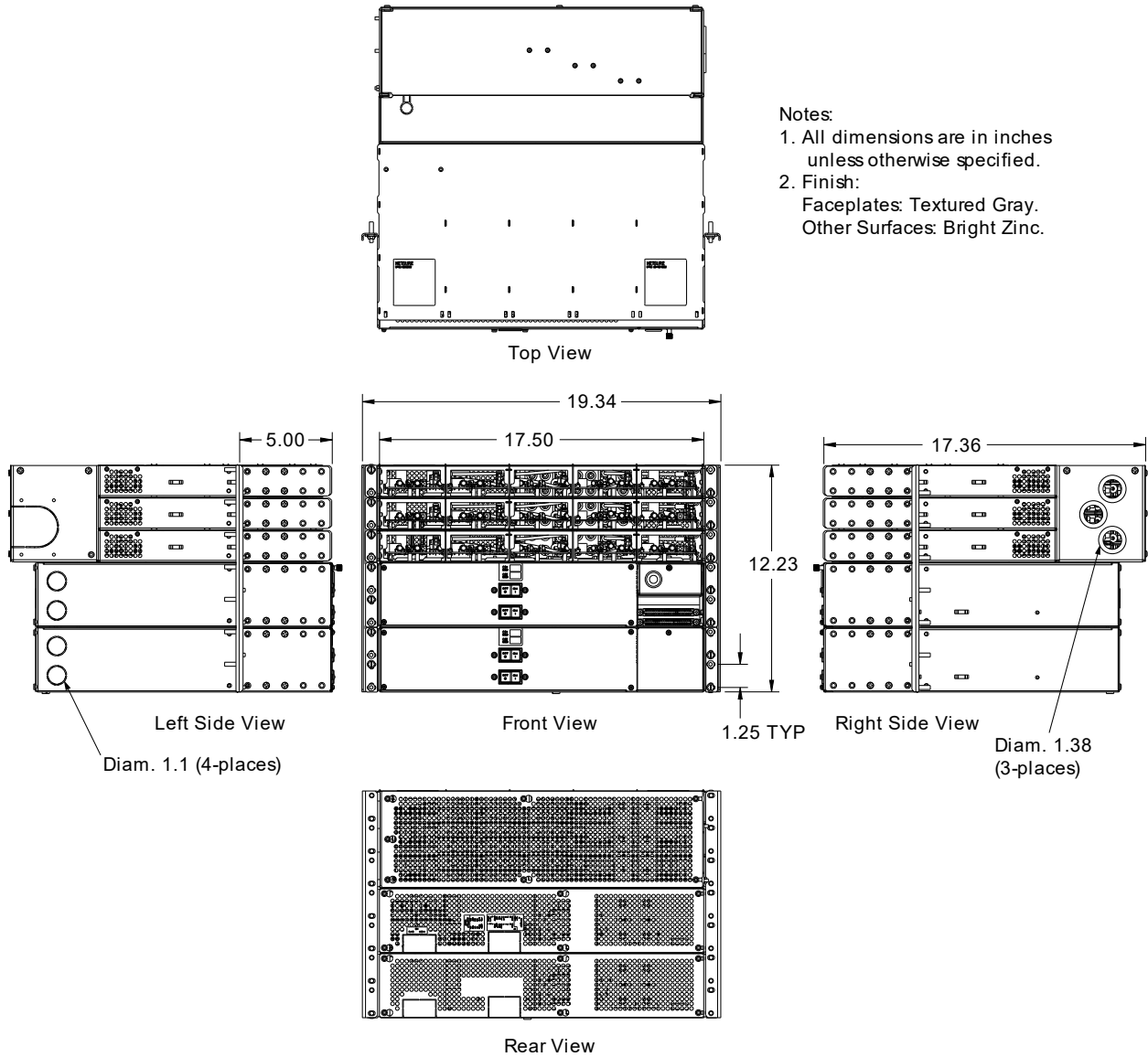

Vertiv™ NetSure™ Inverter System  
System Application Guide

List 05E

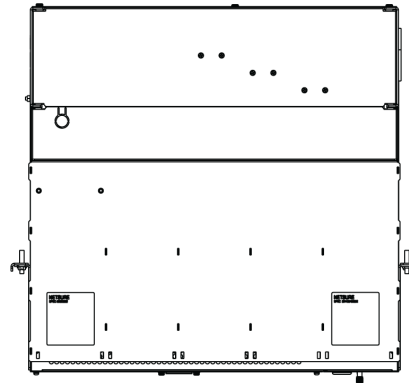

Top View

- Notes:
1. All dimensions are in inches unless otherwise specified.
  2. Finish:  
Faceplates: Textured Gray.  
Other Surfaces: Bright Zinc.

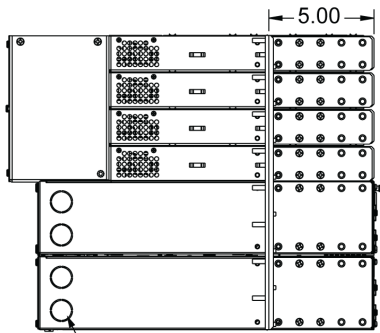

Left Side View

Diam. 1.1 (4-places)

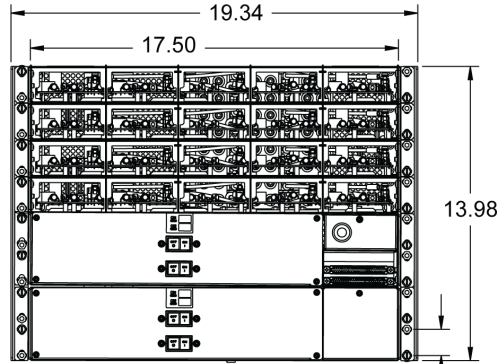

Front View

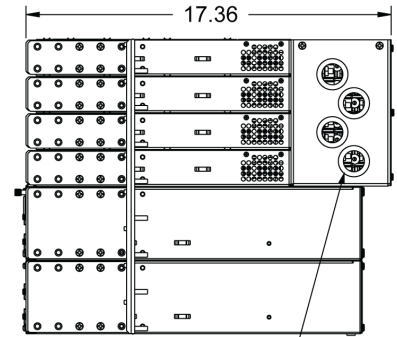

Right Side View

Diam. 1.38 (4-places)

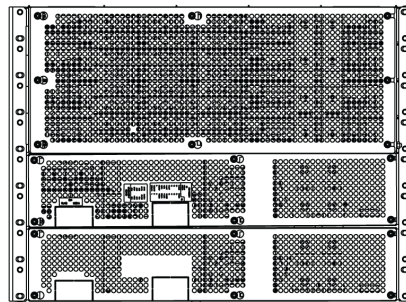

Rear View

Vertiv™ NetSure™ Inverter System  
System Application Guide

List 06

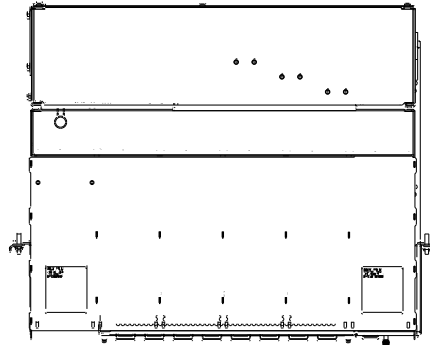

Top View

- Notes:
1. All dimensions are in inches unless otherwise specified.
  2. Finish:  
Faceplates: Textured Gray.  
Other Surfaces: Bright Zinc.

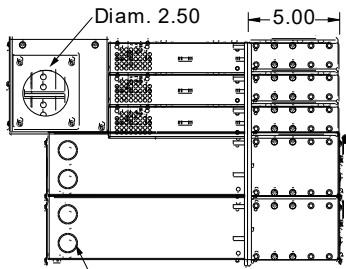

Left Side View  
Diam. 1.1 (4-places)

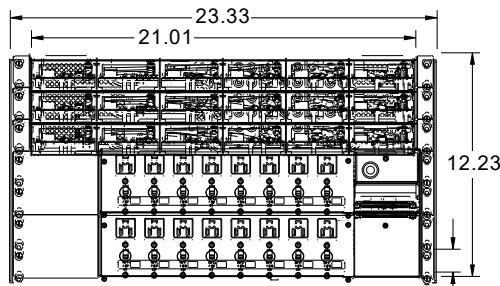

Front View

1.25 TYP

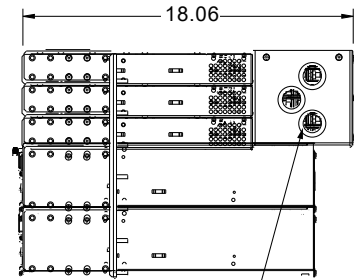

Right Side View

Diam. 1.38 (3-places)

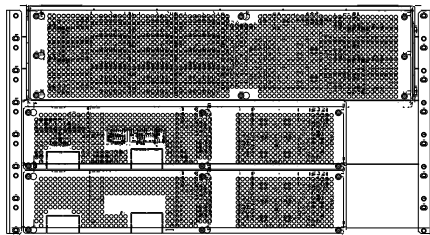

Rear View

Vertiv™ NetSure™ Inverter System  
System Application Guide

List 06E

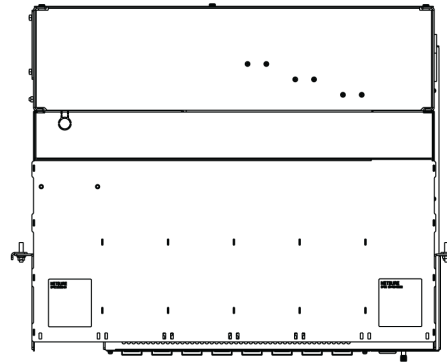

Top View

- Notes:
1. All dimensions are in inches unless otherwise specified.
  2. Finish:  
Faceplates: Textured Gray.  
Other Surfaces: Bright Zinc.

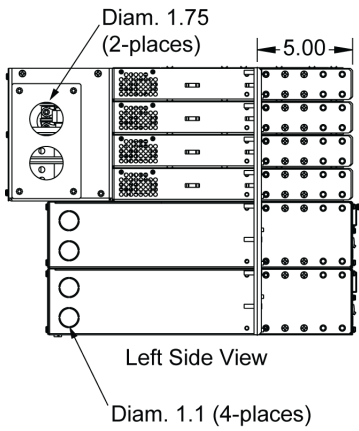

Left Side View

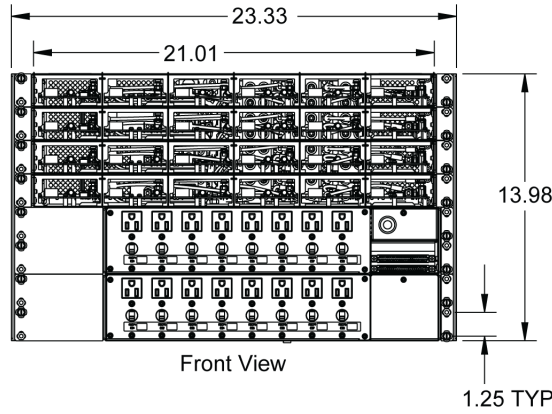

Front View

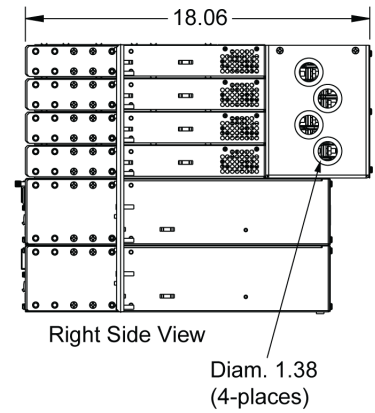

Right Side View

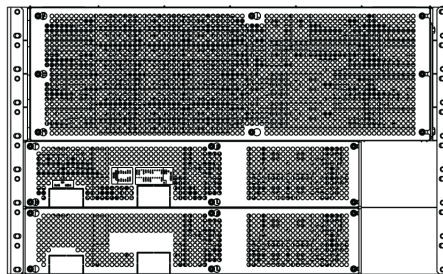

Rear View

**Weights**

List Number or Part Number	Net Weight (lbs), each	Description
<b>Common Equipment</b>		
584130100 List 01	21	19", 5 kVA maximum, Bulk Output Shelf
584130100 List 01E	32	19", 6 kVA maximum, Bulk Output Shelf
584130100 List 02	24	23", 6 kVA maximum (5.76 kVA per NEC breaker de-rating), NEMA Output Shelf
584130100 List 02E	37	23", 6 kVA maximum (5.76 kVA per NEC breaker de-rating), NEMA Output Shelf
584130100 List 03	32	19", 10 kVA maximum, Bulk Output Shelf
584130100 List 03E	54	19", 12 kVA maximum, Bulk Output Shelf
584130100 List 04	37	23", 12 kVA maximum (11.5 kVA per NEC breaker de-rating), NEMA Output Shelf
584130100 List 04E	61	23", 12 kVA maximum (11.5 kVA per NEC breaker de-rating), NEMA Output Shelf
584130100 List 05	53	19", 15 kVA maximum, Bulk Output Shelf - DC INPUT ONLY
584130100 List 05E	63	19", 20 kVA maximum, Bulk Output Shelf - DC INPUT ONLY
584130100 List 06	61	23", 18 kVA maximum (18 kVA per NEC breaker de-rating), NEMA Output Shelf
584130100 List 06E	73	23", 24 kVA maximum (23 kVA per NEC breaker de-rating), NEMA Output Shelf
584130100 List 07	21	19" 5 kVA maximum, NEMA Output Shelf
584130100 List 08	32	19" 10 kVA maximum, NEMA Output Shelf
<b>Inverter Module</b>		
111201000	2.5	Inverter Module
<b>Controller</b>		
1M830BNA10034162	1.25	Standalone Inverter System NCU with HTTPS Protocol

**RELATED DOCUMENTATION**

Installation Instructions:	IM584130100
User Instructions:	UM584130100
NCU Controller Instructions:	UM1M830BNA
Inverter Instructions:	UM111201000
Schematic Diagram:	SD584130100
Wiring Diagram:	T584130100

Vertiv.com | Vertiv Headquarters, 505 N Cleveland Ave, Westerville, OH 43082, USA

© 2024 Vertiv Group Corp. All rights reserved. Vertiv™ and the Vertiv logo are trademarks or registered trademarks of Vertiv Group Corp. All other names and logos referred to are trade names, trademarks or registered trademarks of their respective owners. While every precaution has been taken to ensure accuracy and completeness here, Vertiv Group Corp. assumes no responsibility, and disclaims all liability, for damages resulting from use of this information or for any errors or omissions.

